

2000-483-343

FINAL

**OFFICIAL LIBRARY
COPY**

PROPERTY OF Research and
Planning Fund Grants Mgmt.

RECEIVED

DEC 9 2001

**TWDB R&PF
GRANTS MANAGEMENT**

**Assessment of Weather Modification
As A Water Management Strategy**

**Final Report
From Woodley Weather Consultants
On Contract No. 2000-483-343
To The Texas Water Development Board**

Final Report

**On TWDB Contract No. 2000-481-343 with
Woodley Weather Consultants:**

Assessment of Weather Modification as a Water Management Strategy

Submitted to:

The Texas Water Development Board

By:

**Dr. William L. Woodley, Ph. D., C.C.M., President
Woodley Weather Consultants
11 White Fir Court
Littleton, Colorado 80127
Tel.: (303) 979-7946; Fax: (303) 973-3446
e-mail:Woodley@compuserve.com**

with the Participation of

**George Veni and Associates
San Antonio, Texas**

and

**Bruce Boe
Weather Modification, Inc.
Fargo, North Dakota**

November 24, 2001

Disclosure Statement

Dr. Woodley occasionally serves as a consultant and advisor to Weather Modification, Inc. (WMI) in Fargo, North Dakota. During the summer of 1999, he was retained by WMI for a period of three weeks to conduct seeding training flights for its cloud seeding pilots in the High Plains and Edwards Aquifer cloud seeding programs. In 2000 he completed similar training and evaluation in Mendoza, Argentina, where WMI is conducting a hail suppression program. This is likely to be a continuing consulting relationship.

Table of Contents

	Page
TITLE PAGE	1
DISCLOSURE STATEMENT	2
TABLE OF CONTENTS	3
LIST OF ILLUSTRATIONS	6
LIST OF TABLES	9
EXECUTIVE SUMMARY	16
1.0 INTRODUCTION	38
2.0 AN OVERVIEW OF THE PHYSICS OF CLOUDS AND PRECIPITATION	38
2.1 Cloud Formation	38
2.2 The Development of Cloud Condensates	39
2.3 Dynamic Factors	41
3.0 PRECIPITATION AUGMENTATION CONCEPTS	41
3.1 Cloud Seeding to Improve Precipitation Efficiency (PE)	42
3.2 Cloud Seeding to Promote Cloud Growth	43
4. LAY PERSON'S GUIDE TO IMPORTANT ISSUES OF RELEVANCE TO CLOUD SEEDING FOR RAIN ENHANCEMENT	48
4.1 Need for Pre-Experiment Measurements	48
4.2 Selection of a Design	48
4.3 Randomization	49
4.4 Types of Experiments	50
4.5 Conduct of the Experiment	50
4.6 Estimation of the Target Rainfall	51
4.7 Evaluation of the Experiment	52
5.0 ASSESSMENT OF PRECIPITATION ENHANCEMENT EXPERIMENTS	52
5.1 Worldwide View	52
5.2 Overview for Orographic Clouds	53
5.3 Overview for Convective Clouds	55
5.4 Results of Relevance to Texas	57
6.0 AREAS OF DISAGREEMENT AND UNCERTAINTY	65
6.1 Uncertainty over the Israeli Experiments	66

6.2	Uncertainty over the Climax Experiments.....	69
6.3	Uncertainty over Warm-Season Cloud Seeding Experiments.....	69
6.4	New Stringent Criteria for Assessing the Success of Cloud Seeding Experiments.....	71
7.0	REASONS FOR THE UNCERTAINTY SURROUNDING CLOUD SEEDING EXPERIMENTS.....	70
8.0	A CLOSER LOOK AT THE THAI EXPERIMENT AND ITS IMPLICATIONS FOR TEXAS.....	72
8.1	Overview.....	73
8.2	Time Plots of Unit Rainfalls.....	77
8.3	Attempts to Account for the Natural Rainfall Variability.....	79
8.4	Summary.....	80
9.0	THE TEXAS OPERATIONAL CLOUD SEEDING PROGRAMS.....	80
9.1	Introduction.....	80
9.2	Background.....	81
9.3	Role of Water Districts.....	82
9.4	Origins of a Statewide Program.....	83
9.5	Local Supervision of Seeding Operations.....	84
9.6	The Proliferation of Rain Enhancement Projects.....	85
9.7	State Support of Weather Modification.....	86
10.0	TASK 2 METHODOLOGY AND RESULTS.....	86
11.0	RADAR ESTIMATION OF RAINFALL IN TEXAS.....	90
12.0	TASK 3 METHODOLOGY AND RESULTS.....	92
12.1	The Texas Seeding Targets.....	92
12.2	The Areas of Hydrologic Interest.....	101
12.3	Estimation of Seeding Effects as a Function of Rain Amount and Time.....	104
13.0	ESTIMATION OF THE IMPACTS OF INCREASED SEEDING- INDUCED RAINFALL ON TEXAS SURFACE WATER AND GROUNDWATER SUPPLIES.....	130
13.1	Introduction.....	130
13.2	Methodology.....	130
13.3	Data Analysis and Discussion.....	139
13.4	Edwards Aquifer Focused Calculations.....	178
13.5	Conclusions.....	187
13.6	Recommendations.....	189
14.0	DETERMINATION OF THE OPERATIONAL COSTS OF CLOUD SEEDING	191
14.1	Introduction.....	191

14.2 Background Information.....	192
14.3 Definition of Target.....	197
14.4 Seeding by Aircraft.....	201
14.5 Glaciogenic Seeding Agents.....	203
14.6 Hygroscopic Pyrotechnics and Sprays.....	205
14.7 Seeding Equipment.....	205
14.8 Facility Deployment.....	207
14.9 Aircraft Requirements.....	208
14.10 Personnel.....	213
14.11 Deployment of Aircraft.....	217
14.12 Insurance.....	219
14.13 Projected Costs.....	219
15.0 CONCLUSIONS AND RECOMMENDATIONS.....	222
15.1 Major Study Assumptions and Uncertainties	
15.2 Study Accomplishments	
16.0 ACKNOWLEDGMENTS.....	225
17.0 REFERENCES.....	226
Appendix A: Excerpts from Policy Statements Regarding Weather.....	240
Modification from the American Society of Civil Engineers, the Weather Modification Association, the American Meteorological Society and the World Meteorological Organization	
Appendix B: Satellite-Inferred Cloud Classification for the Operative.....	246
Seeding Targets in 1999 and 2000	
Appendix C: Reprint of article ("Results of Monthly and Seasonal Gauge.....	255
vs. Radar Rainfall Comparisons in the Texas Panhandle") published in the April 2001 issue of the <u>Journal of Weather Modification</u> .	
Appendix D: Glossary of Geologic and Hydrologic Terminology.....	270
Appendix E: Conversions: International System of Units to English Units.....	275
Appendix F: Determination of Mean Aquifer Recharge.....	276
Appendix G: Review of the Draft Final Report on Contract No. 2000-483-343 by the.....	288
Texas Water Development Board	

LIST OF ILLUSTRATIONS

Figure 1. Picture of hard vigorous cloud towers at 1818 CDT on June 5, 2001 taken from 17,000 feet from Cloud 2, the Cessna 340 seeder of the High Plains operational cloud seeding project. The clouds shown were typical on this day.

Figure 2. Idealized cold-cloud conceptual seeding model, revised in June 1999.

Figure 3. Plots of S and NS mean RVR values vs. time interval after unit qualification for the cold cloud experimental units obtained in Thailand in the period 1991-1998.

Figure 4. Plots of mean integrated S and NS RVOL values vs. time interval after unit qualification for the cold cloud experimental units obtained in Thailand in the period 1991-1998.

Figure 5. Processed AVHRR image at 2243 GMT on June 1, 2000. According to the usual color classification, the yellow cumuliform cloud elements indicate they are composed of supercooled droplets while the red areas are the "anvils" of the cumulonimbus tops. The insets show the T vs. r_e plots for the three red-bordered polygons in the image. The colored vertical bars refer to the inferred microphysical zones, where yellow is the diffusional growth zone, green is the zone of coalescence, magenta is the mixed phase zone and red is the glaciated zone. The 10 percentile lines for the pixels having r_e for a given T are plotted. The plot in white is the pixel sample size versus temperature. The vertical white line identifies a r_e of 15 microns, where the population of cloud drops first develops particles of precipitation size.

Figure 6. Map of the 10 operational seeding targets in Texas as of the summer of 2001. The key to the numbered areas is provided in Table 7.

Figure 7. Map of 14 Texas aquifers for which radar rainfall estimates were made. The key to the numbered areas is provided in Table 7.

Figure 8. Map of 14 additional Texas aquifers for which radar rainfall estimates were made. The key to the numbered areas is provided in Table 7.

Figure 9. Map of 12 Texas drainage basins for which radar rainfall estimates were made. The key to the numbered areas is provided in Table 7.

Figure 10. Radar-estimated rainfalls (acre-feet) in the San Antonio urban area during the 2000 season.

Figure 11. Radar-estimated seed and non-seed rainfalls for the San Antonio urban area from 9 April to 30 September 2000.

Figure 12. Map of radar-estimated rainfall (mm) in Texas in 1999.

Figure 13. Map of radar-estimated rainfall (mm) in Texas in 2000.

Figure 14. Comparison of drainage basin size to mean precipitation and changes in effective precipitation from HSIR (seeding induced rainfall).

Figure 15. Comparison of mean annual precipitation to basin size, mean precipitation, and changes in effective precipitation from HSIR

Figure 16. Comparison of the most likely changes in effective precipitation from HSIR to basin size and mean precipitation.

Figure 17. Comparison of changes in recharge from HSIR to recharge rates and recharge zone size.

Figure 18. Comparison of mean unit recharge per aquifer from HSIR to recharge area, recharge rate and change in recharge volume.

Figure 19. Effect of precipitation on pumping of the Edwards Aquifer by San Antonio (from data provided by Bexar Metropolitan Water District and San Antonio Water System).

Figure 20. Texas mean annual precipitation (inches).

Figure 21. The four project zones, based upon average precipitation and anticipated cloud character (continental or maritime).

Figure 22. The rain enhancement projects superimposed on the four project zones shown in Figure 21.

Figure 23. The placement of the sixteen project radars and their respective 100-mile (161 km, 87 nautical mile) ranges.

Figure 24. A 20 mm diameter, 20 g yield glaciogenic, ejectable cloud seeding pyrotechnic.

Figure 25: A 40 g yield burn-in-place (BIP) glaciogenic cloud seeding pyrotechnic.

Figure 26. A wing rack of twelve 1 kg (1,000 g) yield hygroscopic cloud seeding flares. Each cloud turret is treated with a single flare, burned in updraft below cloud base.

Figure 27. A Carley-type wing-tip ice nuclei generator for glaciogenic seeding in updraft below convective cloud base. Shown here is the WMI mounting below the wing-tip of a Cessna 340.

Figure 28. A belly-mounted 102-position rack for ejectable 20 mm, 20 gram glaciogenic pyrotechnics.

Figure 29. A hypothetical target area (gray), with airport and radar cited at central "+". Circles shown depict the maximum ranges attainable for a variety of aircraft, assuming 20 minutes cruise climb from time of takeoff. Speeds depicted are from manufacturer's specifications; actual speeds when rigged for cloud seeding operations will be less. Aircraft types are as follows: A-Cherokee 140, B-Single Comanche, C-Turbo Aztec, D-Seneca II, E-Cessna 340, F-100 mi radar range ring, and G-Cheyenne II turboprop.

LIST OF TABLES

Table 1. Summary of important randomized cloud seeding experiments.

Table 2. Summary of the results of experiments of relevance to Texas (All but the Nelspruit, South African experiment made use of AgI. Dry Ice was used in the South African experiment).

Table 3. Summary of the Thai RVOL results for the unit lifetimes (RVOL in units of 10^3m^3).

Table 4. Cloud classification matrix of rankings.

Table 5. Mean convective rankings for the Texas operational seeding targets by month and overall for April through September in 1999 and 2000 (The first number in the set is sample size in days and the second number is the cloud classification).

Table 6. Apparent effect of seeding (seeding factor) vs. the supercooled rainwater index and the satellite cloud index (Based on an overall seeding factor of 1.43, which was obtained from multiple linear regression).

Table 7. Area key for the radar rainfall analyses.

Table 8. Monthly and seasonal radar-estimated rain volumes ($\text{m}^3 \times 10^3$) for the Texas seeding targets in 1999.

Table 9. Monthly and seasonal radar-estimated rain volumes ($\text{m}^3 \times 10^3$) for the Texas seeding targets in 2000.

Table 10. Monthly and seasonal radar-estimated rain volumes ($\text{m}^3 \times 10^3$) in 1999 for the Texas areas of hydrologic interest.

Table 11. Monthly and seasonal radar-estimated rain volumes ($\text{m}^3 \times 10^3$) in 2000 for the Texas areas of hydrologic interest.

Table 12. Range of seeding factors (SF) to be applied to the hydrologic areas as a function of area size.

Table 13. Range of hypothetical seeding effects for the Texas seeding targets in 1999.

Table 14. Range of hypothetical seeding effects for the Texas seeding targets in 2000.

Table 15. Range of hypothetical seeding effects for the hydrologic areas in 1999.

Table 16. Range of hypothetical seeding effects for the hydrologic areas in 2000.

Table 17. Effects of hypothetical seeding as a function of rain amount for the seven targets operative in 1999.

Table 18. Effects of hypothetical seeding as a function of rain amount for the seven targets operative in 2000.

Table 19. Daily radar estimated rain volumes (acre-feet) in the San Antonio urban area in 2000. The third column contains the hypothetical seeded rainfalls.

Table 20. Area-averaged seasonal rainfall (mm) for the Texas areas in 1999 and 2000.

Table 21. Surface water drainage basin key to Figure 9 and general hydrologic parameters.

Table 22. Average historic evapotranspiration for major Texas cities (Texas A&M University, 2001)

Table 23. Stream drainage areas, discharges and contributions from rainfall.

Table 24. Aquifer recharge zone key to Figures 7 and 8, and general hydrogeologic parameters.

Table 25. Estimated effects of HSIR (hypothetical seeding-induced rainfall) on surface water in the Lower Basin of the Brazos River; units are given in acre-feet.

Table 26. Estimated Effects of HSIR on surface water in the Middle Basin of the Brazos River; units are given in acre-feet.

Table 27. Estimated effects of HSIR on surface water in the Upper Basin of the Brazos River; units are given in acre-feet.

Table 28. Estimated effects of HSIR on surface water in the Lower Basin of the Colorado River; units are given in acre-feet.

Table 29. Estimated effects of HSIR on surface water in the Middle Basin of the Colorado River; units are given in acre-feet.

Table 30. Estimated effects of HSIR on surface water in the Upper Basin of the Colorado River; units are given in acre-feet.

Table 31. Estimated effects of HSIR on surface water in the Lower Basin of the Guadalupe River; units are given in acre-feet.

Table 32. Estimated effects of HSIR on surface water in the Upper Basin of the Guadalupe River; units are given in acre-feet.

Table 33. Estimated effects of HSIR on surface water in the Lower Basin of the Nueces River; units are given in acre-feet.

Table 34. Estimated effects of HSIR on surface water in the Upper Basin of the Nueces River; units are given in acre-feet.

Table 35. Estimated effects of HSIR on surface water in the Lower Basin of the Trinity River; units are given in acre-feet.

Table 36. Estimated effects of HSIR on surface water in the Upper Basin of the Trinity River; units are given in acre-feet.

Table 37. Estimated gains in rainfall (P) from HSIR, uniformly distributed in the Lower Basin of the Brazos River; units are given in centimeters.

Table 38. Estimated gains in rainfall (P) from HSIR, uniformly distributed in the Middle Basin of the Brazos River; units are given in centimeters.

Table 39. Estimated gains in rainfall (P) from HSIR, uniformly distributed in the Upper Basin of the Brazos River; units are given in centimeters.

Table 40. Estimated gains in rainfall (P) from HSIR, uniformly distributed in the Lower Basin of the Colorado River; units are given in centimeters.

Table 41. Estimated gains in rainfall (P) from HSIR, uniformly distributed in the Middle Basin of the Colorado River; units are given in centimeters.

Table 42. Estimated gains in rainfall (P) from HSIR, uniformly distributed in the Upper Basin of the Colorado River; units are given in centimeters.

Table 43. Estimated gains in rainfall (P) from HSIR, uniformly distributed in the Lower Basin of the Guadalupe River; units are given in centimeters.

Table 44. Estimated gains in rainfall (P) from HSIR, uniformly distributed in the Upper Basin of the Guadalupe River; units are given in centimeters.

Table 45. Estimated gains in rainfall (P) from HSIR, uniformly distributed in the Lower Basin of the Nueces River; units are given in centimeters.

Table 46. Estimated gains in rainfall (P) from HSIR, uniformly distributed in the Upper Basin of the Nueces River; units are given in centimeters.

Table 47. Estimated gains in rainfall (P) from HSIR, uniformly distributed in the Lower Basin of the Trinity River; units are given in centimeters.

Table 48. Estimated gains in rainfall (P) from HSIR, uniformly distributed in the Upper Basin of the Trinity River; units are given in centimeters.

Table 49. Estimated effects of HSIR on the flow of the Brazos River in the Lower Basin; units are given in acre-feet except where marked as percentages.

Table 50. Estimated effects of HSIR on the flow of the Brazos River in the Middle Basin; units

are given in acre-feet except where marked as percentages.

Table 51: Estimated effects of HSIR on the flow of the Brazos River in the Upper Basin; units are given in acre-feet except where marked as percentages.

Table 52: Estimated effects of HSIR on the flow of the Colorado River in the Lower Basin; units are given in acre-feet except where marked as percentages.

Table 53: Estimated effects of HSIR on the flow of the Colorado River in the Middle Basin; units are given in acre-feet except where marked as percentages.

Table 54: Estimated effects of HSIR on the flow of the Colorado River in the Upper Basin; units are given in acre-feet except where marked as percentages.

Table 55: Estimated effects of HSIR on the flow of the Guadalupe River in the Lower Basin; units are given in acre-feet except where marked as percentages.

Table 56: Estimated effects of HSIR on the flow of the Guadalupe River in the Upper Basin; units are given in acre-feet except where marked as percentages.

Table 57: Estimated effects of HSIR on the flow of the Nueces River in the Lower Basin; units are given in acre-feet except where marked as percentages.

Table 58: Estimated effects of HSIR on the flow of the Nueces River in the Upper Basin; units are given in acre-feet except where marked as percentages.

Table 59: Estimated effects of HSIR on the flow of the Trinity River in the Lower Basin; units are given in acre-feet except where marked as percentages.

Table 60: Estimated effects of HSIR on the flow of the Trinity River in the Upper Basin; units are given in acre-feet except where marked as percentages.

Table 61: Estimated potential effects of HSIR on recharge of the Hueco-Mesilla Bolson Segment of the Alluvium and Bolson aquifer; $R = 2.1\%$ per Table 24; all units below are given in acre-feet.

Table 62: Estimated potential effects of HSIR on recharge of the Rio Grande to Nueces River Segment of the Carrizo-Wilcox Aquifer; $R = 5.3\%$ per Table 24; all units below are given in acre-feet.

Table 63: Estimated potential effects of HSIR on recharge of the Nueces River to Guadalupe River Segment of the Carrizo-Wilcox Aquifer; $R = 8\%$ per Table 24; all units below are given in acre-feet.

Table 64: Estimated potential effects of HSIR on recharge of the Guadalupe River to Colorado River Segment of the Carrizo-Wilcox Aquifer; $R = 5\%$ per Table 24; all units below are given in

acre-feet.

Table 65: Estimated potential effects of HSIR on recharge of the Colorado River to Brazos River Segment of the Carrizo-Wilcox Aquifer; R = 5% per Table 24; all units below are given in acre-feet.

Table 66: Estimated potential effects of HSIR on recharge of the Brazos River to Trinity River Segment of the Carrizo-Wilcox Aquifer; R = 5% per Table 24; all units below are given in acre-feet.

Table 67: Estimated potential effects of HSIR on recharge of the Trinity River to Sulfur River Segment of the Carrizo-Wilcox Aquifer; R = 4% per Table 24; all units below are given in acre-feet.

Table 68: Estimated potential effects of HSIR on recharge of the Eastern Segment of the Carrizo-Wilcox Aquifer; R = 4% per Table 24; all units below are given in acre-feet.

Table 69: Estimated potential effects of HSIR on recharge of the San Antonio Segment of the Edwards (Balcones Fault Zone) Aquifer; R = 15.7% per Table 24; all units below are given in acre-feet.

Table 70: Estimated potential effects of HSIR on recharge of the Barton Springs Segment of the Edwards (Balcones Fault Zone) Aquifer; R = 21.7% per Table 24; all units below are given in acre-feet.

Table 71: Estimated potential effects of HSIR on recharge of the Northern Segment of the Edwards (Balcones Fault Zone) Aquifer; R = 19.3% per Table 24; all units below are given in acre-feet.

Table 72: Estimated potential effects of HSIR on recharge of the Central Segment of the Edwards-Trinity Aquifer; R = 2.1% per Table 24; all units below are given in acre-feet.

Table 73: Estimated potential effects of HSIR on recharge of the Stockton Plateau Segment of the Edwards-Trinity Aquifer; R = 2.5% per Table 24; all units below are given in acre-feet.

Table 74: Estimated potential effects of HSIR on recharge of the Trans-Pecos Segment of the Edwards-Trinity Aquifer; R = 2.5% per Table 24; all units below are given in acre-feet.

Table 75: Estimated potential effects of HSIR on recharge of the Rio Grande to Nueces River Segment of the Gulf Coast Aquifer; R = 2% per Table 24; all units below are given in acre-feet.

Table 76: Estimated potential effects of HSIR on recharge of the Nueces River to Brazos River Segment of the Gulf Coast Aquifer; R = 2% per Table 24; all units below are given in acre-feet.

Table 77: Estimated potential effects of HSIR on recharge of the Brazos River to Sabine River Segment of the Gulf Coast Aquifer; R = 2% per Table 24; all units below are given in acre-feet.

Table 78: Estimated potential effects of HSIR on recharge of the Northwest Segment of the Ogallala Aquifer; R = 2.5% per Table 24; all units below are given in acre-feet.

Table 79: Estimated potential effects of HSIR on recharge of the Northeast Segment of the Ogallala Aquifer; R = 2.2% per Table 24; all units below are given in acre-feet.

Table 80: Estimated potential effects of HSIR on recharge of the Central Segment of the Ogallala Aquifer; R = 2.4% per Table 24; all units below are given in acre-feet.

Table 81: Estimated potential effects of HSIR on recharge of the Southern Segment of the Ogallala Aquifer; R = 2.7% per Table 24; all units below are given in acre-feet.

Table 82: Estimated potential effects of HSIR on recharge of the Lower Glen Rose Segment of the Trinity Aquifer; R = 20.1% per Table 24; all units below are given in acre-feet.

Table 83: Estimated potential effects of HSIR on recharge of the South Central Segment of the Trinity Aquifer; R = 6.5% per Table 24; all units below are given in acre-feet.

Table 84: Estimated potential effects of HSIR on recharge of the North Central Segment of the Trinity Aquifer; R = 4% per Table 24; all units below are given in acre-feet.

Table 85: Estimated potential effects of HSIR on recharge of the Northern Segment of the Trinity Aquifer; R = 1.5% per Table 24; all units below are given in acre-feet.

Table 86: Precipitation measured in San Antonio used as representative of rainfall means and extremes.

Table 87: Estimated effects of mean annual recharge from HSIR on the mean elevation of the potentiometric surface in the San Antonio Segment of the Edwards (Balcones Fault Zone) Aquifer as represented at the J-17 well; J-17 values are given in feet above mean sea level and R values are given in feet.

Table 88: Mean monthly precipitation and hypothetical discharge of Hondo Creek from HSIR at the King Waterhole gauging station; HSIR and L units are given in acre-feet; P units are given in centimeters.

Table 89: Estimated effects of HSIR on recharge to the Edwards Aquifer in the Hondo Creek basin; HSIR, L, and R units are given in acre-feet.

Table 90: Estimated effects of HSIR on urban water use of the Edwards Aquifer in San Antonio; units are given in acre-feet.

Table 91: Comparison of estimated Edwards Aquifer HSIR-based recharge; units are given in acre-feet/km².

acre-feet/km².

Table 92. Definition of Radar Operations Centers' Areas of Primary Responsibility (APRs)

Table 93. Assignment of Aircraft by Areas of Primary Responsibility (APRs)

Table 94. Cost Estimates for an Eight-Month Operational Period (March 1 – October 31)

EXECUTIVE SUMMARY

Woodley Weather Consultants (WWC) has made an assessment of cloud seeding for rain enhancement as a water management strategy for Texas under contract with the Texas Water Development Board (TWDB). The results are presented in this Final Report, which also has a strong educational component. The investigation is broken down into the following tasks:

- Task 1. Compilation of worldwide evidence concerning the efficacy of cold-cloud seeding for rain enhancement. This includes results obtained in Texas during intermittent experimentation in the period 1986-1994 and in Thailand for the Royal Thai Government (RTG) in a randomized six-year (1993-1998) cloud seeding experiment. Both experiments, which were under the direction of Dr. Woodley, suggest, but do not prove, that cloud seeding increases rainfall.
- Task 2. Estimation of statewide seeding opportunities in the growing season (1 April through 30 September) using calculations from satellite imagery made during the 1999 and 2000 seasons by the research team of Woodley and Rosenfeld for the Texas Natural Resource Conservation Commission (TNRCC).
- Task 3. Estimation of the amount of additional rainfall to be expected in Texas from seeding under various weather regimes as a function of space and time using the information obtained in Tasks 1 and 2. The original intent was to do this for periods of above normal, normal and below-normal rainfall to provide an estimate of the quantity and reliability of the rainfall enhancements to be expected in Texas from cloud seeding under these three natural rainfall scenarios. Because of normal to below normal rainfall during the period of study, however, the above-normal scenario could not be examined.
- Task 4. Estimation of the impacts and reliability of increased seeding induced rainfall on the water supply. It includes a more detailed case study of the potential hydrological impacts of cloud seeding on the Edwards Aquifer.
- Task 5. Determination of the operational costs of producing potential increases in water supply from cloud seeding.

The study does not include performing any estimates of agricultural or other economic benefits from cloud seeding. A review of the first draft of this Final Report by the Texas Water Development Board under contract No. 2000-483-343 is provided in Appendix G.

Major Study Assumptions and Uncertainties

This investigation is a broad, conceptual examination of the potential impacts of hypothetical seeding induced rainfall (HSIR) on the hydrogeology of Texas. Because of the many assumptions and uncertainties inherent to the study, its results must be viewed qualitatively rather than quantitatively. Most critical is the assumption that glaciogenic cloud seeding

enhances rainfall on an area basis. Although the collective evidence suggests that cloud seeding increases rainfall from individual clouds and cloud clusters, proof of its efficacy on an area basis does not exist (Task 1). Much of this research is based on the results of a randomized cloud seeding experiment over floating targets in Thailand. Although the apparent seeding effects are large, ranging as high as +91%, they are not statistically significant and they are confounded by the natural rainfall variability. A more realistic, but still uncertain, estimate of the effect of seeding, based on linear regression, is +43% for floating targets of about 2,000 km². In addition, the climate and terrain differences between Thailand and Texas raise additional questions about the transferability of the Thai results to Texas. Further, the apparent seeding effects in Thailand and elsewhere must be extrapolated to hydrogeologic areas of various size, typically larger much larger than the targets of past experimentation, in order to meet the goals of this study. In one scenario, these extrapolations are made as a function of satellite inferred cloud microphysical structure (Task 2); again based on past research results in Thailand. Because of these uncertainties, a range is assigned (i.e., low, middle and high) to the hypothetical area seeding effects to be superimposed on the radar-estimated rainfalls (Task 3). Further quantification would not be reliable in view of the uncertainties.

In view of the many uncertainties associated with this study, many of which are beyond reliable quantification, it is emphasized that the HSIR values generated are meant to be illustrative of likely potential general impacts on surface and groundwater resources, consistent with hydrogeologic principles and the hydrogeologic settings of the study areas. The values should not be considered definitive or precise and have not been subjected to an intense statistical analysis since such results would suggest a greater certainty in the values than in fact exists. The data produced by this study are meant to guide future research to areas where HSIR would likely be most productive. However, the radar-estimated natural area rainfall, likely accurate to within $\pm 20\%$ on a monthly basis, during the period of study has influenced these guidelines. Thus, those areas that did not appear suitable for cloud seeding intervention might have fared differently had the input natural rainfalls been greater.

Natural Processes and Seeding Concepts

As background for Task 1, the study begins with an overview of the physics of clouds and precipitation, including a discussion of the processes leading to the formation of clouds and the development of cloud condensates. This leads naturally to the presentation of precipitation augmentation concepts, including cloud seeding to improve precipitation efficiency (PE), sometimes called "static" cloud seeding, and seeding to alter the circulations that sustain the clouds, leading to increased cloud growth, duration and rainfall, sometimes called "dynamic" cloud seeding. Both are misnomers.

"Static" seeding is a misnomer, because it is not possible to produce the hypothesized microphysical changes in the clouds without changing their dynamics. If "static" seeding initiates and augments rainfall from clouds, their downdrafts will be affected. This is a dynamic effect, so "static" seeding affects cloud dynamics. Conversely, "dynamic seeding," which is the approach used in Texas, focusing primarily on enhancing rainfall by altering the circulations that sustain the clouds, can only attain its purpose by first producing changes in the cloud microphysical structure.

The history of the "dynamic" cloud seeding conceptual model from the mid-1960's to the present is addressed in detail because of the pivotal role it plays in Texas. In its present form the conceptual model involves a hypothesized series of meteorological events beginning initially on the scale of individual treated clouds or cells and cascading ultimately to the scale of clusters of clouds. This seeding is hypothesized to produce rapid glaciation of the supercooled cloud liquid water content (SLWC) in the updraft by freezing preferentially the largest drops so they can rime the rest of the cloud water into graupel (soft irregular snow pellets). This seeding-induced graupel is postulated to grow much faster than raindrops of the same mass so that a larger fraction of the cloud water is converted into precipitation before being lost to other processes. Ice multiplication is not viewed as a significant factor until most of the cloud water has been converted into precipitation. This faster conversion of cloud water into ice precipitation enhances the release of latent heat, increases cloud buoyancy, invigorates the updraft, and acts to spur additional cloud growth and/or support the growing ice hydrometeors produced by the seeding. These processes result in increased precipitation and stronger downdrafts from the seeded cloud and increased rainfall in the unit overall through downdraft interactions between groups of seeded and non-seeded clouds, which enhance their growth and merger. "Secondary seeding," whereby non-seeded clouds ingest ice nuclei and ice embryos produced by earlier seedings, is thought also to play a role in the precipitation enhancements.

The Design, Conduct and Evaluation of Seeding Experiments

Issues of relevance to the design, conduct and evaluation of cloud seeding experiments are addressed. Such experiments begin with a conceptual model of the sequence of meteorological events to be expected after seeding, leading ultimately to increased precipitation. This is followed by a systematic program of measurement using aircraft, radar and satellites to determine whether the clouds in the prospective target area have the characteristics assumed by the conceptual model.

The pre-experiment measurements are followed by the selection of a design (e.g., crossover, target-control and single target) by which the efficacy of the seeding in increasing precipitation is to be tested. The crossover design, which is the most efficient, involves two targets with a buffer zone between them. On each day of suitable conditions a treatment decision, which specifies which target is to be seeded and which is to be left untreated, is drawn from a randomized sequence. The experiment then proceeds according to the randomized instructions. The evaluation of the crossover experiment is made by forming the double ratio: $R1S/R2NS//R1NS/R2S$ where R1S and R1NS refers to the rainfall (R) in Target 1 when it was seeded (S) and non-seeded (NS), respectively, and R2S and R2NS refers to the rainfall (R) in Target 2 when it was seeded (S) and not-seeded (NS), respectively. This design requires that the rainfalls in the two targets be highly correlated (e.g., correlation > 0.70).

A second alternative is the target-control experiment. With this design the treatment decision is randomized for the target (i.e., S or NS) and the upwind control is never seeded. The evaluation of the target-control experiment is done by forming the double ratio: $RS/CS//RNS/CNS$ where RS and RNS refer to the target rainfall on S and NS days, respectively, and CS and CNS refer to the rainfall in the control area on S and NS days, respectively. Seeding is never done in the control area. Thus, it serves to detect biases on the S and NS days and this

mean bias in the form of the ratio CS/CNS is used to correct for what is assumed to be a corresponding bias in the target. Again, the utility of this approach depends on a strong correlation between the rainfall in the target and the rainfall in the upwind control area. Such correlations normally do not exist in convective regimes such as those in Texas.

The third alternative is the single target design for which the treatment decision is randomized (i.e., either S or NS). The single target can be fixed to the earth or it can drift with the wind. This design is the least efficient, because only one target is seeded on each day and there is no formal way to account for the natural rainfall variability by using control areas. Despite its limitations, the single target design is the only one that has been possible for dynamic cloud seeding experiments in Texas.

All three designs require randomization of the treatment decisions. This is done to avoid the possibility of human bias in the selection of the treatment decision. Randomization also makes it possible to employ "double-blind" procedures whereby the treatment decision is not known by the experimenters in the field and the analysts in the laboratory until the analysis of the experiment has been completed. In addition, randomization, if employed for many cases, is useful also in minimizing the impact of the natural rainfall variability that usually confounds the interpretation of cloud seeding experiments.

Within the context of a given design there are several types of experiments. If successful, the most persuasive is one in which the design, conduct and evaluation of the experiment are specified beforehand (i.e., *a priori*). Everything is done according to the *a priori* design and the results of the experiment are evaluated, where a P value of 0.05 normally is deemed necessary to achieve statistical significance. "P-values" refer to the results of statistical tests where a P-value is the probability that a particular result could have occurred by chance. The lower the P-value the stronger the result and the lower the probability it could have occurred by chance. The statement that a result is statistically significant is reserved for *a priori* experiments.

If the intent of a particular experiment is to confirm the results obtained by seeding elsewhere in the world, it should attempt to duplicate all that was done in that experiment. Further, it should state what is to be done beforehand. When this is done, the experiment becomes an *a priori* confirmatory experiment. If completed successfully with P values < 0.05, the experiment would be statistically significant.

Experiments whose designs and execution change during the course of the experiment are considered exploratory. Likewise, experiments that achieve P values < 0.05 for after-the-fact (i.e., *a posteriori*) analyses of seeding effects are also considered exploratory. Most experiments fall into this category. An exploratory experiment with strong P-value support still cannot be judged statistically significant and is, therefore, not as persuasive as the *a priori* experiment. The only way to solidify the results from an exploratory experiment is to confirm them with *a priori* experimentation, either in the same area or in another part of the world.

A major challenge comes in the conduct of the experiment. The biggest problem is delivering the nucleant to the clouds at the times and places it is needed. If individual clouds are to be seeded and evaluated, the nucleant must be introduced when the cloud is in its active

growth phase. If seeding takes place late in the life of the cloud, the hypothesized changes are not likely to take place. Likewise, if groups of clouds are to be seeded over either a fixed or floating target area, many clouds actually must be seeded repetitively in a timely fashion in order to enhance the rainfall over that area.

A crucial aspect of all rain enhancement experiments is the estimation of target rainfalls. The word "estimation" is used rather than "measurement," because there is no way to measure rainfall with absolute accuracy, especially convective rainfall with strong cores and gradients.

Radar is an attractive alternative for the estimation of convective rainfall, because it provides the equivalent of a very dense gauge network. Radar estimation of rainfall is, however, a complex undertaking, involving determination of the radar parameters, calibration of the system, anomalous propagation of the radar beam, concerns about beam filling and attenuation, and the development of equations relating radar reflectivity to rainfall rate, where radar reflectivity is proportional to the sixth power of the droplet diameters in the radar beam. Because these Z-R equations depend on the drop sizes in the clouds, the radar is going to make errors in estimating the precipitation, if the scanned clouds contain drop sizes that are different from those that went into the derivation of the equations. Further, if the clouds of interest do not fill the radar beam, errors will also result. Z-R relationships also are contaminated when hail is present due to the transition from Rayleigh to Mie scattering at C-band wavelengths.

Such problems are not likely to engender much confidence in the short-term radar estimation of rainfall, although it is shown in this report that the Texas NEXRAD radars perform quite well over the period of a month or longer. Fortunately, the interest in cloud seeding experiments is in the ratio of S to NS rainfalls. Thus, if the errors the radar makes apply equally well to the S and NS clouds, the estimate of seeding effect should be unaffected by the errors. If on the other hand, the radar under or overestimates the rainfall from the S clouds relative to the NS clouds, the apparent seeding effect may be spurious, due not to the seeding but to radar errors. This possibility was investigated during the Florida experiments by measuring the droplet sizes in rainfall from S and NS clouds. No differences in drop sizes were detected (Cunning, 1976). Thus, the radar estimate of seeding effect should still be valid.

The absolute amount of rainfall to be realized from seeding is still in question, because of evaporative losses in the drier air beneath the clouds. The only way this can be estimated is through comparison of the radar rainfall estimates with the measurement of rainfall by rain gauges in clusters or small arrays. Such comparisons will allow for adjustment of the radar rainfall estimates everywhere within scan of the radar. With such a system the estimates should be better than those provided by radar or rain gauges alone.

The evaluation phase of an experiment focuses on the results of the seeding. Even if the conceptual model is valid and even if the seeding was conducted properly, there is still no guarantee of success. Only if the natural rainfall variability, which can mask an effect of seeding, can be overcome will it be possible to detect a seeding effect; given there is one to detect.

In theory, randomization of the treatment decision should take care of the natural rainfall variability. If the experiment goes on long enough, it is assumed that an equal percentage of the

naturally wet and dry days will be apportioned randomly to seeding and controls (i.e., not seeded). If so, the mean rainfall differences between the seeded and non-seeded storms should be a measure of the effect of seeding. If this is not so, the mean rainfall differences might be due to the disproportionate random allocation of wet or dry days to either the seeded or not seeded categories.

There are two ways to beat this unwanted outcome. The first is to conduct the experiments for long periods to insure that the allocation of rain events is not biased. The second is to devise a way to make accurate forecasts of rainfall in the target in the absence of seeding. If this were possible, the evaluation of a seeding experiment would be trivial. One would predict the target rainfall in the absence of seeding and then measure what actually occurred, secure in the knowledge that the difference between measured and predicted rainfall is due to the seeding. Unfortunately, this has not been employed successfully and conclusively in a confirmatory cloud seeding experiment, and it explains the continuing uncertainties over the results of cloud seeding.

All of this is academic, of course, when it comes to operational cloud seeding programs, since operational seeding is rarely randomized. This makes their unbiased evaluation especially difficult.

Assessment of Randomized Cloud Seeding Experiments Worldwide

An overview of the results of randomized cloud seeding experiments worldwide is provided in this report. Excerpts from the "official" views of the status of weather modification by the American Society of Civil Engineers, the Weather Modification Association, the American Meteorological Society, and the World Meteorological Organization are provided also in Appendix A. Although the details differ from assessment to assessment, there is a general consensus that cloud seeding enhances precipitation under some conditions and produces no effect or even a negative effect under other conditions. The evidence is strongest for the seeding of individual clouds and weakest for area precipitation. No *a priori* project, involving the seeding of warm season convective clouds over a fixed or floating target area has achieved statistical significance.

The report then takes a closer look at specific orographic and convective cloud seeding experiments, including those with "static" and "dynamic-mode" conceptual models. The main focus is on the series of dynamic-mode experiments of relevance to Texas, beginning over the Caribbean Sea in the mid-1960's, Florida in the 1970's, Texas in the 1980's and early 1990's, and Thailand in the 1990's. In addition, experiments in Cuba and South Africa are examined.

Taken collectively, the results of relevance to Texas over the years suggest that seeding with an ice nucleant might be useful for enhancing area rainfall, although proof from a single experiment is still lacking. The best estimate of area increases in rainfall for the experimental units range between 25% and 45%, depending on area size. Despite these uncertainties, operational cloud seeding to increase precipitation has been conducted intermittently over the past 40 years at various locations around the world. The current program in Texas, which now involves 10 project sites, is the latest in a long line of such programs.

Uncertainties Surrounding the Results and Interpretation of Cloud Seeding Experiments

Areas of uncertainty surrounding the results and interpretation of cloud seeding experiments are addressed in this report. A critique of glaciogenic seeding experiments from the perspective of Dr. Bernard A. Silverman has been published in the Bulletin of the American Meteorological Society (Silverman, 2001). Special attention is focused on the wintertime rain enhancement experiments in Israel, the Climax, Colorado snow augmentation experiments and the series of warm-season dynamic-mode seeding experiments. Silverman's general view of the status of glaciogenic seeding experiments for precipitation enhancement is embodied in the following from his paper:

“Based on a rigorous examination of the accumulated results of the numerous experimental tests of the static-mode and dynamic-mode seeding concepts conducted over the past 4 decades, it has been found that they have not yet provided either the statistical or physical evidence required to establish their scientific validity. Exploratory, post-hoc analyses of some experiments have suggested possible positive effects of seeding under restricted meteorological conditions, at extended times after seeding and, in general, for reasons not contemplated in the guiding conceptual seeding models; however, these exploratory results have never been confirmed through subsequent experimentation.”

Woodley and Rosenfeld (2001) submitted a Commentary to the Bulletin of the American Meteorological Society regarding the Silverman (2001) paper in August 2001. As of November 2001, however, when this Final Report was completed, their Commentary had not been published. An overview of their position as it relates to dynamic-mode seeding is embodied in the following:

“In our view the BAS (Bernard A. Silverman) assessment of the status of glaciogenic cloud seeding experimentation is unduly pessimistic. Although we agree that no single dynamic-mode area seeding has satisfied the statistical assessment criteria applied by BAS, we contend that the collective weight of the evidence favors the postulate that seeding enhances rainfall. Virtually every entry in his Table 2, providing a summary of the main statistical results of the various dynamic-mode seeding experimentation discussed in his article has a SR (single ratio, S/NS) value > 1 with varying levels of P-value support. Quantification of the seeding effect requires the proper form of meta-analysis. It should be cautioned, however, that the results of such an analysis would pertain to dynamic cloud seeding as a whole and would not necessarily provide statistical evidence for the efficacy of cloud seeding in any particular experiment.”

The biggest contributor to the uncertainty over cloud seeding experiments is the natural rainfall variability, which can confound the interpretation of the results. It can hide an effect of seeding in the natural rainfall noise or it can conspire to suggest an effect of seeding when in fact none is present. This is especially a problem for projects with small samples. There are potentially two ways to minimize the problem of natural rainfall variability. One is to obtain a huge sample such that the effect of seeding, assuming that one is present, is readily detected despite the

background noise from the natural rainfall variability. The notion that “things will even out in the long run” is applicable here. The second way to overcome the natural rainfall variability is to use covariates to develop equations that predict the natural target rainfall. If this were possible, departures from the predicted rainfall then could be attributed to the seeding intervention.

Another reason for the uncertainty surrounding cloud seeding experiments has been the lumping together of all seeding events in which the effects of seeding were mixed such that there appears to be no effect of seeding. The apparent effect of seeding depends on the cloud microstructure with large apparent effects in one category and no apparent effect in another. It is crucial, therefore, to know how seeding affects the clouds so that the data can be partitioned into analysis categories and seeding effects can be sought within each category. If no effect is evident in the category thought most suitable for seeding, there will be legitimate reason for concern. Under such circumstances, all seeding should stop until the matter is resolved.

The last and most obvious contributor to the uncertainty surrounding cloud seeding is that there are situations in which it does not produce the intended effect. Cloud seeding is an exceptionally challenging undertaking involving complex cloud and environmental processes that are not fully understood. Compounding this is the difficulty of conducting the seeding in order to produce the desired effect. It is easy to understand, therefore, why many seeding experiments have been inconclusive.

A Closer Look at the Thai Experimentation

The Thai cold-cloud experiment is highly relevant to Texas. The design and conduct of the randomized experiments in Texas and Thailand are very similar and the same scientists (Woodley and Rosenfeld) designed, directed and evaluated both programs. Further, the results for Thailand and Texas are very similar after accounting for some of the natural rainfall variability. In addition, the conduct of the seeding operations in both Texas and Thailand are very similar to what is being done now in the operational cloud seeding programs of Texas. Although it is not a perfect match, the Thai experiment is the most relevant of any known experiment to what is being done in Texas. As such, it merits a closer look.

The Thai randomized, cold-cloud, rain enhancement experiments were carried out during 1991-1998 in the Bhumibol catchment area in northwestern Thailand. These experiments involved exploratory experimentation in 1991 and 1993, which suggested increases in rainfall due to seeding. This was followed by a “demonstration” experiment to determine the potential of on-top AgI seeding for the enhancement of areal (over 1,964 km²) rainfall. It was conducted in accordance with a moving-target design. The treatment units were vigorous supercooled clouds forming within the experimental unit, having a radius of 25 km and centered at the location of the convective cloud that qualified the unit for initial treatment. The unit drifted with the wind as the S-band project radar collected 5-min volume-scan data to be used for the evaluation of cell and unit properties.

Evaluation of the demonstration experiment, consisting of 62 experimental units (31 S and 31 NS), gave a S (11,519 x 10³ m³) to NS (6,021 x 10³ m³) ratio of mean rain volumes over the unit lifetimes of 1.91 at a statistical P value of 0.075. The ratio of S (5,333 x 10³ m³) to NS

($3,516 \times 10^3 \text{ m}^3$) median rainfalls is 1.52. Evaluation of the units at 300 minutes after their qualification, which has historical precedent, gave a S ($7,930 \times 10^3 \text{ m}^3$) to NS ($5,348 \times 10^3 \text{ m}^3$) ratio of mean unit rainfalls of 1.48 at a P value of 0.123. Thus, the demonstration experiment fell short of statistical significance at a P value of 0.05, regardless of the period of evaluation.

Although the Thai “demonstration” experiment did not reach significance in the time allotted to it, there is much to be gained by exploratory examination of the entire data set (43 S and 42 NS). It is emphasized that P-values obtained for exploratory analyses do not carry the same weight as P-values obtained for the results of analyses of *a priori* experiments. Beginning on the scale of the individual treated cells, it was found that the ratio of S to NS rain volumes is 1.37 at a P-value of 0.066. The other cell parameters have P-values < 0.05 except for the echo height. These results suggest that seeding increases the rain volume from individual cells by increasing their maximum radar reflectivities, inferred maximum rainfall rates, maximum areas, maximum rain-volume rates, duration, and their clustering and merger with other cells. These results are similar to comparable exploratory cell analyses in Texas.

The mean rain volumes for the unit durations are $10,398.78 \times 10^3 \text{ m}^3$ for the S sample and $5,404.19 \times 10^3 \text{ m}^3$ for the NS sample, giving a S/NS ratio of 1.92. Six huge S units, whose rain volumes exceed the largest value in the NS sample, dominate this result. Deletion of the wettest S ($105,504 \times 10^3 \text{ m}^3$) and wettest NS ($17,709 \times 10^3 \text{ m}^3$) units as a sensitivity test gave a revised S ($8,134 \times 10^3 \text{ m}^3$) to NS ($5,104 \times 10^3 \text{ m}^3$) ratio of rain volumes of 1.59 at a P value of 0.040. Normalization of the entire sample to the overall NS mean unit rainfall to account for year effects decreased the apparent effect slightly (1.88) but improved the P value slightly to 0.009.

Linear regression analyses to account for the natural rainfall variability in the experiment suggest a smaller apparent effect of seeding. The ratio of S to NS unit rainfalls after accounting for up to 30% of the natural rainfall variability ranges between 1.43 and 1.73 at P values of 0.136 and 0.063, respectively. Although the poor correlations between the covariate candidates and the unit rainfalls (all < 0.55) make the accuracy of these estimates problematic, it is still likely that the natural rainfall variability favored the S sample to some extent.

The Thai results suggest also that the effect of seeding depends on the internal cloud structure, especially the intensity of coalescence, whereby smaller cloud drops of varying sizes collide and coalesce into larger raindrops. The strongest apparent effect, exceeding well over 100% even after correction for the natural rainfall variability, is evident in clouds with some coalescence and raindrops. The apparent effect is smaller for clouds with no coalescence. In clouds with intense coalescence the apparent effect of seeding is near zero or even negative. Such clouds glaciate very rapidly and are not suitable for seeding according to the seeding conceptual model. These results underscore the importance of using AVHRR satellite imagery to specify the cloud structure over Texas during the summers of 1999 and 2000 as a precursor to the estimation of seeding effects over the State.

The assessment of past cloud seeding experiments, especially those of relevance to Texas, provides strong but not conclusive evidence for the efficacy of cloud seeding for the augmentation of rainfall. There is a basis, therefore, for the systematic assessment by the Texas Water Development Board of cloud seeding as a water management tool in Texas. Because of

the many assumptions and uncertainties, however, the results of such a study must be interpreted qualitatively rather than quantitatively.

History of Cloud Seeding In Texas

The history of cloud seeding in Texas is recounted to serve as the backdrop for the proposed studies for the TWDB. Because of the arid and semi-arid climate of two-thirds of the state, Texas has periodic droughts and a long history of attempts to augment the natural water supply through weather modification, most recently through cloud seeding. The modern era of cloud seeding in Texas began with the passage of the Texas Weather Modification Act by the Texas Legislature in 1967. It was a tacit acknowledgment that the use of cloud-seeding technology had earned a measure of acceptance within the water-management community in Texas. At the same time, the law recognized that many uncertainties remained with respect to the effectiveness of various forms of cloud seeding. Hence, the need to regulate the level of human intervention in cloud processes to protect the interests of the public, and to promote the development of a viable and demonstrable technology of cloud seeding, was addressed by that legislative act.

To attain the objective mandated by the Texas Legislature to develop and refine cloud-seeding technologies, the State of Texas took a first step by linking up with the U. S. Bureau of Reclamation in 1973 to devise and demonstrate a viable cloud-seeding technology. Since then, an on-going, though often intermittent, research effort has ensued to corroborate and quantify the effects of timely seeding of convective clouds. Despite limited funding over the years, substantial progress has been made in pursuit of this goal. These are recounted in this report.

Identification of Seeding Opportunities in Texas

The results of the Thai experimentation indicate that the effect of seeding depends in part on the intensity of coalescence in the clouds. If one is to identify seeding opportunities in Texas, therefore, one must first specify cloud microphysical structure. This was possible in this study through the analysis of AVHRR satellite imagery to determine the effective radius (r_e) of a cloud population vs. temperature in the manner described by Rosenfeld and Lensky (1998). The first step involved assignment of a microphysical cloud classification to each of the Texas seeding targets on each of the days for which analyzed data were available. Targets having clouds on a given day with intense supercooling and/or no coalescence received a classification of 1 whereas targets having clouds with warm glaciation temperatures and/or early warm glaciation received a classification of 5. The results show an increase in cloud classification from northwest to southeast throughout Texas. This means that the clouds in Texas become more maritime in character, having increasing coalescence and glaciation, as distance from the Gulf Coast decreases. This is consistent with the rainfall climatology for the State.

The next step in the recognition of seeding opportunities was the conversion of the convective rankings to hypothetical seeding effects using the results from the Thai experiment, which indicate that the largest apparent seeding effect comes in clouds with weak to moderate coalescence. The apparent seeding effect is negligible in clouds with intense coalescence. These findings were crucial to the study, because they made it possible to assign a probable seeding

effect for each target as a function of the satellite-measured cloud structure on each day for which measurements were available. The procedures are described in this Report.

Radar Estimation of Rainfall in Texas

Making the assessment of the potential alteration of rainfall by seeding and the impact of the alterations on the water supplies of Texas requires the statewide measurement of convective rainfall. This is a major challenge. The point measurement of convective rainfall with rain gauges is an accepted standard, even though gauges are subject to errors due to wind and disturbance of the airflow by nearby obstacles. Even so, it would take hundreds of recording rain gauges to measure the rainfall accurately throughout Texas. The official climatological rain gauge network of Texas consists of 182 recording rain gauges, which is inadequate for the measurement of rainfall from convective clouds and cloud systems. Supplemental recording gauges are available in the state but they are too few and too widely spaced to be of much value in measuring Texas convective rainfall.

Gauge and radar estimates of monthly and seasonal (April-September in 1999 and 2000) convective rainfall were compared for a large network in the Texas Panhandle. In 2000, the network, covering approximately $3.6 \times 10^4 \text{ km}^2$ ($1.4 \times 10^4 \text{ mi}^2$), contained 505 fence-post rain gauges with individual, subterranean, collector reservoirs at a density of one gauge per 72 km^2 (29 mi^2). These were read monthly to produce area-averaged rain totals, obtained by dividing the gauge sums by the number of gauges in the network. The gauges were not read in September 2000 because of negligible rainfall. Comparable radar-estimated rainfalls for the same time periods were generated using merged, base-scan, 15-min, NEXRAD radar reflectivity data supplied by the National Weather Service through WSI, Inc. and the Global Hydrology Resource Center.

The gauges vs. radar comparisons were made on the basis of rain patterning and area averages. The Z-R relationship used to relate radar reflectivity (Z) to rainfall rate (R) was $Z = 300R^{1.4}$, which is the equation used in standard NEXRAD practice. Because all of the rain gauges could not be read on a single day, the gauges do not provide an absolute basis of reference for comparison with the radar estimates, which were made in time periods that matched the average date of the gauge readings. The gauge and radar monthly rain patterns agreed in most instances, although the agreement in August 2000 was poor. The monthly correlations of gauge and radar rain amounts were 0.86 in 1999, 0.96 in 2000 and 0.93 for the two years combined. The radar tended to underestimate heavy rain months and overestimate those with light rain. The radar overestimate for months with light rain may be due to evaporative losses beneath the level of the radar scan as the drops fell through dry air to the ground.

The period of comparison affected the results. The area-average gauge vs. radar comparisons made on a monthly basis agreed to within 20% on 5 of the 11 months compared. Upon comparison of the gauge and radar rainfalls on a two-month basis to diminish the impact of variations in the date of the gauge readings, it was found that all but one of the five comparisons was within 5%. The exception (April/May 1999) differed by 16%. The seasonal gauge and radar estimates in 1999 and 2000 agreed to within 4% and 8%, respectively, which is

extraordinary considering the uncertainties involved. Thus, the longer the period of comparison the better the agreement appeared to be. It is concluded that the use of radar in Texas can provide an accurate representation of rain reaching the ground on a monthly and seasonal basis.

Estimation of Area Seeding Effects

The TWDB contract calls for estimation of the amount of additional rainfall to be expected in Texas from seeding under various weather regimes as a function of space and time. This was done on a daily basis for 51 areas. These included the 10 seeding targets, 40 areas of hydrologic interest and all of Texas. The period of "daily" rain estimation was tied deliberately to the convective cycle, beginning at 0700 CDT on the day of interest to 0659 CDT the next day.

Initial estimates of the hypothetical effect of seeding on each day for each seeding target were obtained by taking the product of the daily radar-estimated rainfall and the appropriate hypothetical seeding factor. The former was obtained by integrating the 15-min NEXRAD base-scan reflectivity data. The latter was obtained by converting the satellite cloud classifications listed in Appendix B for each day to a seeding factor in the manner described in the report. It was necessary also to extrapolate the cloud classification values to days without direct measurements.

Once the daily estimates of seeded and non-seeded rainfalls were available, they were summed to obtain the "seeded" (S) and non-seeded (NS) rain volumes by month and for the entire 1999 and 2000 seasons. Results, including the differences (S-NS) and ratios (S/NS) of S and NS rainfalls, are provided in the report. The daily calculations from which the monthly and seasonal values were derived are available on computer disk.

Strictly speaking the results are applicable only to areas of around 2,000 km² (about 800 mi²), which was the size of the floating target in Thailand, since the hypothetical effect of seeding used in this study, expressed as a percentage of the "natural" rainfall, depends on scale. Based on past Texas and Thai experimentation, the seeding factor on the scale of individual clouds having base areas averaging 75 km² (29 mi²) is on the order of 1.75 (i.e., +75%). When dealing with the Texas and Thai experimental units covering 1,964 km² (758 mi²), the seeding factor after adjusting for the natural rainfall variability drops to about 1.43 (i.e., +43%). The apparent effect of seeding in the FACE-1 (Florida) seeding target covering 13,000 km² (5,019 mi²) was 1.23 (i.e., +23%). Most of the Texas seeding targets are larger than the FACE target, suggesting that the overall effect of seeding, expressed as a percentage above the natural rainfall, should be somewhat smaller still, probably on the order of +10%. Therefore, upon considering the size of the Texas targets, it is assumed that the high, middle and low estimates of seeding effects for the Texas seeding targets are one-half, one-quarter and one-eighth of the calculated values. This is discussed further in the Report.

In considering the results, it should be remembered that radar does not provide an absolute measure of the rainfall, so errors should be considered in estimating rainfall and the probable increments due to seeding. As it turns out, however, the errors for radar estimates of monthly and seasonal precipitation are much smaller than the probable uncertainties associated with the imposition of seeding effects. At worst the radar estimates of rainfall for this study are

probably in error by no more than $\pm 20\%$. This is less than the uncertainties with respect to the expected effects of seeding.

The next step as was the radar estimation of the daily, monthly and seasonal rainfalls for the 40 areas of hydrologic interest. The main challenge was the superposition of seeding effects on these hydrologic areas. The initial intention was to attempt an extrapolation of the target results to the hydrologic areas. Upon examining the data, however, this seemed neither possible nor wise, because the results do not show a systematic trend through Texas. In adopting a conservative approach, it was decided that a range (i.e., high, middle and low) of seeding factors would be applied to the hydrologic areas as a function of their size, based on the results of past experimentation.

The TWDB contract calls for estimation of the effects of seeding under conditions of above normal, near normal and below normal rainfall. Unfortunately, the rainfall in Texas in April to September in 1999 and 2000 was below normal. It was possible, however, to infer the effect of seeding in Texas on days in these periods with heavy, moderate and light natural rainfall. This exercise depended in part on the well-known finding with respect to convective rainfall that typically 10% of the days with measurable rainfall in any time period account for 50% of the rainfall produced in that time period. For the purposes of this study, these were called heavy rain days. Elaborating further, 50% of the days with measurable rain produce 90% of the rainfall measured in that time period. Thus, the 40% second wettest days produce 40% of the rainfall. These were called moderate rain days. Finally, the remaining 50% of the days with measurable convective rainfall produce at most only 10% of the total rainfall in the period of interest. These were called light rain days.

To determine the hypothetical effect of seeding as a function of the natural rainfall in a given time period (e.g., a month) and target, the radar-estimated rainfalls were sorted in descending order from the greatest to the least after assignment of a seeding factor based on the satellite measured cloud structure. Thus, the sorted natural rainfalls brought their hypothetical seeded rainfalls with them. Then, the number of days with measurable rain in the period was determined. If one assumes for the purposes of illustration that a target had 20 days during a month with measurable rainfall, then the wettest two days are heavy rain days, the next wettest 8 days are moderate rain days and the remaining 10 days with rain are light rain days.

Mean natural (unseeded) and seeded rainfalls were then determined for each category and the hypothetical effect of seeding by category was determined. This was done by differencing the S and NS rainfalls to obtain volumetric increments and by forming the ratio of S to NS rainfall to obtain percentage increases. Much can be learned from this presentation. First, 10% of the days with rain $> 10^5 \text{ m}^3$ produced 54% and 56% of the rainfall during the 1999 and 2000 seasons, respectively. Second, 50% of the days with rain exceeding this threshold during the 1999 and 2000 seasons produced 97% and 98% of the rain volume, respectively. Third, the other half of the days with rain was inconsequential in terms of rain production. Fourth, the percentage increases in rainfall due to hypothetical seeding are as large on the wettest 10% of the days as they are on the other days and the rain increments are larger on the wet days. If true, this suggests that there would be considerable benefit from seeding on days with heavy convective rainfall. This is somewhat of a surprise, since it was assumed that the internal cloud structure

would be less suitable on such days. **These results also suggest that there is little to be gained by seeding on at least half of the days with rain, since doubling or even tripling of the rainfall would still be of little consequence. The challenge is in identifying such days in advance of the seeding operations so that project resources are not wasted in unproductive seeding operations.**

The effect of natural rainfall and its enhancement by seeding depends not only on total rain amount but also on its distribution in time. Fortunately, the data from this study make it possible to generate tabulations and time plots of the rainfall in all of the areas. Examples are provided in the Report.

To obtain a picture of the rain distribution in Texas during the 1999 and 2000 seasons the area-averaged rainfalls (in mm) were calculated for each of the 50 areas. In agreement with climatological expectations East Texas was considerably wetter than West Texas in both years. The Panhandle was quite wet in 1999 but less so in 2000. The wettest region for the two years combined was in North Texas along the Red River to the north of Dallas-Ft. Worth. The radar-estimated area-average rainfalls in Texas during the 1999 and 2000 seasons were 234 mm (9.21 inches) and 171 mm (6.73 inches), respectively. The data also permitted the production of rain maps for any area and for any time period. Seasonal rain maps for 1999 and 2000 are provided in the report.

Estimation of the Impacts and Reliability of Increased Seeding Induced Rainfall on the Water Supply

A major component of the investigations was the Task 4 assessment of the general hydrological impacts of seeding-induced rainfall (HSIR) on major Texas river drainage basins and aquifers. The general effects of monthly values of HSIR were estimated for the discharge of the Brazos, Colorado, Guadalupe, Nueces, and Trinity Rivers and for the groundwater recharge of the Alluvium and Bolson, Carrizo-Wilcox, Edwards-Trinity, Gulf Coast, Ogallala, and Trinity Aquifers. In addition, a more detailed smaller-scale study was conducted on the effects of HSIR on groundwater recharge in portions of the San Antonio Segment of the Edwards (Balcones Fault Zone) Aquifer. Water losses to evapotranspiration and to soils were considered in the calculations.

This investigation was intended as a broad, conceptual examination of the hypothetical impacts of HSIR. The values generated for this study are meant to be illustrative of likely general impacts on surface and groundwater resources, consistent with hydrogeologic principles and the hydrogeologic settings of the study areas. The values should not be considered definitive or precise and have not been subjected to an intense statistical analysis since such results would suggest a greater certainty in the values than in fact exists. The data produced by this study are meant to guide future research to areas where HSIR would likely be most productive. The following conclusions are based on this premise and the results of this investigation.

Surface Water Studies

1) General studies of effective precipitation should limit the size of the watersheds investigated to no more than 10,000 km², or use radar or other means to account for ET losses in only the rainfall-affected areas.

2) HSIR will have relatively little overall impact on the Lower and Middle basins of the Brazos River, the Middle Basin of the Colorado River, the Lower Basin of the Nueces River, and the Lower and Upper basins of the Trinity River.

3) HSIR is likely to have the most impact, hypothetically ranging from 9 to 17% above mean historic six-month precipitation, in the Upper Basin of the Brazos River, the Lower and Upper basins of the Colorado and Guadalupe rivers, and the Upper Basin of the Nueces River.

4) HSIR during August hypothetically produces little significant effective rainfall because of the low natural rainfall. Low volumes are expected during July and September, but significant volumes are hypothetically possible if appropriate meteorological conditions are present.

5) The greatest proportional and volumetric change in stream discharge from HSIR may hypothetically occur in the Upper and Lower Basins of the Nueces and Guadalupe rivers, the Lower Basin of the Trinity River, the Middle Basin of the Colorado River, and the Middle Basin of the Brazos River.

6) The smallest proportional and volumetric change in stream discharge from HSIR may hypothetically occur in the Upper Basin of the Colorado River and Upper Basin of the Brazos River.

7) HSIR during August hypothetically produces little or no significant increase in stream discharge, although hypothetically, notable gains may occur in the Lower Basin of the Colorado River, the Upper and Lower basins of the Guadalupe River, and the Lower Basin of the Trinity. Low volumes are hypothetically likely during July and September, but hypothetically significant increases may occur if appropriate meteorological conditions are present.

8) HSIR in the Lower Basin of the Trinity River and possibly in the Lower Basin of the Brazos River should not be applied without further research. The water needs of these areas are currently satisfied by the available water resources, and occasional catastrophic flooding of streams in the northeast part of the coastal bend demand only limited and carefully modeled HSIR, possibly for only July through September when HSIR will have its lowest yield and when water demand is highest.

Groundwater Studies

1) Hypothetically, HSIR will probably be most effective in providing recharge that can be stored and retrieved for use in the following aquifers, listed in descending order of effectiveness: Edwards, Carrizo-Wilcox (excluding the Eastern and Trinity to Sulfur River segments), Trinity (excluding the Northern Segment), Edwards-Trinity, and Ogallala (Central and Southern Segments). Potential recharge from HSIR in these aquifers could occur at mean annual rates of

about 4-30 acre-feet/km² of recharge zone.

2) HSIR will probably be least effective in providing recharge that can be stored and retrieved for use in the Gulf Coast Aquifer and the Hueco-Mesilla Bolson Segment of the Alluvium and Bolson aquifers. Potential recharge from HSIR in these aquifers could occur at mean annual rates of about 0.2 to 1.2 acre-feet/km² of recharge zone.

3) HSIR during August hypothetically produces little significant increase in recharge.

Edwards Aquifer Focused Studies

1) The modeled HSIR data for 1999 and 2000 are adequate for this study's preliminary assessment of the effect of HSIR on aquifer recharge during below-normal and normal rainfall years because they respectively represent below-normal and normal rainfall periods. The modeled data are probably not adequate to effectively assess recharge from HSIR during above-normal rainfall years.

2) During below-normal rainfall years, hypothetically recharge of the aquifer could be increased 50,464 acre-feet/year (62.2 million m³/year) by HSIR.

3) During normal rainfall years, hypothetically recharge of the aquifer could be increased 97,840 acre-feet (120.7 million m³) by HSIR.

4) During above-normal rainfall years, hypothetically recharge of the aquifer could be increased at least 97,840 acre-feet (120.7 million m³) by HSIR. Much recharge during high potentiometric levels typical of such periods would be very short-lived before discharging, but other recharge would enter high volume, low permeability storage. The volumetric gain in storage compared to water loss though increased discharge is not known.

5) Recharge in the Hondo Creek drainage basin could hypothetically be increased 1,168 acre-feet (1.44 million m³) to 11,071 acre-feet (13.66 million m³) during the months of April to September. Total hypothetical recharge during this period would constitute a 2.3 to 5.6% increase to the total recharge of the Edwards Aquifer.

6) HSIR over the city of San Antonio would hypothetically reduce pumping of the Edwards Aquifer by about 1,770 to 3,540 acre-feet/year (2.18 to 4.37 million m³/year). This is about 6-13 times less than the hypothetical volume of recharge from HSIR on an equal size portion of the aquifer's recharge zone.

Recommendations for Hydrologic Studies

Further studies of HSIR should focus on the specific areas discussed below. That research should utilize computer modeling of the radar-based precipitation to not only precisely measure rainfall, but to calculate ET, and to model the hydrologic characteristics of the underlying surface watersheds and groundwater recharge zones. Statistical modeling and analysis of those results would be warranted. Decisions that will be made from the results of this study should consider

the water needs of communities, which were not examined in this report, and prioritize future research and/or actual seeding for areas where water demand and the potential water yield from HSIR are both high.

Surface Water Studies

1) The impacts of HSIR on effective precipitation throughout surface water drainage basins should be further studied in the Upper Basin of the Brazos River, the Lower and Upper basins of the Colorado and Guadalupe rivers, and the Upper Basin of the Nueces River. If cloud seeding is considered in advance of further research for the purpose of increasing overall effective precipitation, it should be primarily directed at these areas.

2) The tabulated results of this study should be compared with surface water needs in the studied drainage basins and the potential for damage from stream flooding. HSIR research and implementation in the central and west Texas drainage basins listed in the previous paragraph should be prioritized based on needs and impacts.

Groundwater Studies

1) The impacts of HSIR on recharge should be further studied in those aquifers suggested through this investigation as having the greatest potential to receive and retain recharge for human use: Edwards, Carrizo-Wilcox (excluding the Eastern and Trinity to Sulfur River segments), Trinity (excluding the Northern Segment), Edwards-Trinity, and Ogallala (Central and Southern Segments). If cloud seeding is considered in advance of further research, it should be primarily directed at these areas.

2) The tabulated results of this study should be compared with groundwater needs in the studied aquifers. HSIR research and implementation in the aquifers listed in the previous paragraph should be prioritized based on needs and impacts.

3) Detailed water budget studies are needed for the karst aquifers, especially the Edwards-Trinity, to better define the hydrology in those areas and the potential impacts of HSIR.

4) HSIR appears to be least effective in providing recharge to the Hueco-Mesilla Bolson Segment of the Alluvium and Bolson aquifers. However, given the significant need for water in the El Paso area, further research is warranted to confirm these results or to find ways to enhance them.

Edwards Aquifer Focused Studies

1) Digital hydrologic models of the Edwards Aquifer should be used to study the effects of HSIR on recharge. A new model is currently under development (Geary Schindel, Edwards Aquifer Authority, personal communications, 2001). The models should examine aquifer response to aquifer-wide HSIR and HSIR within selected drainage basins to determine which basins will allow the greatest recharge. HSIR should then be directed to those areas. The models should consider that recharge in different drainage basins will have varying effects through the aquifer, and HSIR should be applied to those where the maximum desired benefit would occur.

HSIR in non-recharge zone areas to limit demand for aquifer water should be modeled to determine if conditions could be identified when the relatively small benefit of HSIR would be warranted in those areas.

2) The effect of HSIR during normal and above-normal rainfall years should be modeled to determine the potential for long-term benefits in aquifer storage and yield.

3) While HSIR over the city of San Antonio appears to produce relatively little benefit compared to HSIR over the Edwards Aquifer recharge zone, a similar comparison should be made with rainfall over cropland during the growing season when pumping for irrigation is greatest. In studying the cropland scenario, or if further study is made of HSIR over San Antonio, the maximum possible reduction in pumping should be determined to limit the extent for which the recession coefficient of equation 4 can be applied.

Determination of the Operational Costs of Producing Potential Increases in Water Supply from Cloud Seeding

Having laid the scientific foundation for cloud seeding, assessed the evidence for its efficacy and estimated the hypothetical increases in water supply to be realized by cloud seeding in Texas, the final task was the determination of the operational costs of cloud seeding over an enormous area in Texas (approximately 199,800 square miles, or about 128 million acres) that would most benefit from cloud seeding. In view of the present state of knowledge, however, it is questionable whether an effort of this magnitude would be warranted at this time. Even so, it is useful to see what it would cost. The accepted program could then be scaled back from that.

The project design plans set forth herein are not intended as a short-term means to deal with drought, but as a long-term water management tool. The impact of any precipitation enhancement weather modification program will be greatest when weather patterns are "normal", or even on the wet side, for cloud modification does not "make" precipitation, but instead helps nature be more efficient, producing fractional increases in the precipitation received.

To establish the large operational target area the hydrologic cycle and the Texas climate were considered. Texas was divided into four zones based on cloud structure and rainfall and the target area was "carved" from these zones. Nearly three-fourths of Texas is included in the target, which includes the western and central portions of the state and contains 16 radar sites, each staffed by two meteorologists. The overall project will have four technicians, each assigned to one of four Maintenance Regions. The importance of co-locating all project operations, including aircraft and pilots, at one location is emphasized.

The cost assessment also considers the types of cloud seeding that might be applied in the seeding target. Only seeding from aircraft is considered, because it allows timely delivery of the nucleant to the place it is needed most. Both glaciogenic and hygroscopic seeding are considered, and the techniques and equipment, especially aircraft, needed to do the job are discussed. Typically, aircraft with higher performance are required for "on-top" seeding than for seeding at cloud base.

In the context of the plan, individual Areas of Primary Responsibility (APRs) within the target are defined and treated as a whole. This means that although aircraft are based within each APR, their operations are not limited only to that area. Because weather systems generally move in a more-or-less predictable progression, fewer aircraft can be deployed, with the understanding that each may conduct operations in APRs adjacent to that in which each is based. Some infrastructure must first be set forth in order for this arrangement to function effectively. This is detailed in the report.

Each APR will have a certain number of aircraft assigned to it, depending upon its area, proximity to other regions, the number of adjacent areas that also have available aircraft, and whether or not it is on an upwind side of the greater project area, e.g., whether or not it has the responsibility for the initial response to those clouds first moving into the state (Table 93). These "initial response" regions, from north to south, are: North Plains, High Plains, Colorado River, Far West, South Pecos, Texas Border, Southwest, and Far South. Clouds may develop within the regions, or upwind of them. Only the "initial response" regions must deal with both; the other regions will for the most part only be dealing with clouds that develop within their borders, or with those leaving (and therefore previously treated by) other regions.

The deployment of facilities and equipment is a major consideration for the huge seeding target. Wherever possible, existing radars and aircraft being used in the current operational seeding projects are integrated into the effort, and a means of sharing the resources on a cost-reimbursable basis is described.

Likewise, the seeding aircraft must also be shared. Examination of other successful rainfall enhancement programs reveals that the number of aircraft deployed is a balance between what is needed to do the job in the "worst case" scenario, and what can be afforded. In other words, if a target area sometimes has enough clouds to keep eight aircraft busy, but usually only half that many, that project will typically deploy the lower number, or perhaps even slightly less, depending upon budget considerations.

Because all APRs will be in regular contact with each other, the aircraft resources can be shared effectively with adjacent APRs, reducing the need for any one APR to have as many aircraft as they might have operating as an independent entity. Under this plan about 41 seeder aircraft would be required for the entire target area.

Personnel needs, especially qualified seeding pilots, are addressed. Because any seeding effect must begin with the pilots, the need for highly experienced pilots is emphasized. Likewise highly trained meteorologists and technicians also are required. This likely will require the program to implement its own training program to assure itself of a reservoir of trained personnel.

The cost estimate for the program is \$18.8 million the first season and \$7.5 million in subsequent years. These are only estimates, subject to fluctuations in the aviation market, the price of avgas, and numerous other variables. The cost categories are radar, cloud base and cloud top seeder aircraft, seeding agents, and meteorological support services. No costs are included for data collection (other than the burning of monthly CDs for archival purposes) quality control,

or analysis. The question of just how to analyze such an expansive program must be addressed separately. At this point it is estimated that such an analysis program would cost upwards of \$500,000 per year.

Conclusions and Overall Recommendations

The assessment of weather modification as a water management strategy for Texas has been completed successfully with the achievement of all objectives. It began by laying the scientific foundations for cloud seeding efforts and ended by providing costs estimates for a massive cloud seeding effort over the portions of Texas thought to be most suitable for cloud seeding intervention. Much has been learned along the way. Although one can make the argument that cloud seeding increases rainfall, it is not yet a proven technology when applied on an area basis. As discussed in this Report, the reasons for this are many and varied. In the case of the randomized seeding experimentation in Texas, the funding agency stayed with the program for only 2 of its scheduled 5 full seasons, despite potentially positive results that had been obtained up to the time of project termination. In retrospect premature termination of this program was a serious blunder whose effects are still being felt today.

The limited and non-conclusive evidence for seeding-induced increases in rainfall has provided the basis for this assessment of the potential of cloud seeding as a water management strategy for Texas. It involved the radar estimation of rainfall over the entire state and 50 subareas of interest (seeding targets, drainage basins and aquifers) for the 1999 and 2000 seasons (April through September). Hypothetical seeding effects were superimposed on these radar-estimated rainfalls for the 10 existing Texas seeding targets as a function of the satellite derived cloud structure, where the relationship between cloud structure and seeding effect was obtained from cloud seeding research by the first author in Thailand. Although the approach for the 40 hydrologic areas was somewhat different, the end result is about the same in suggesting that cloud seeding could be beneficial to some areas in Texas, although the associated costs and resulting benefits are currently uncertain. Estimated increases in seasonal rainfall of about 10% are suggested for the largest areas (i.e., > 50,000 km²), and hypothetically nearly a doubling of the rainfall may be possible for the smallest areas (i.e., < 1,000 km²) under consideration.

One of many assumptions in this study is that the seeding nucleant can and will be delivered by experienced pilots to all of the target clouds at the time and place that it will be most effective. Even with the use of aircraft, this assumption is probably not valid on some occasions in the real world in which some program managers "cut corners" to fit their effort into their budget. Although this is understandable, it is unwise. Thus, the estimates of HSIR are likely too high in view of current seeding practice, which often falls well short of the ideal. This is an area in which improvement is needed.

The availability of merged NEXRAD radar reflectivity data from which rainfall was derived was a major plus for this study. It was the only way monthly and seasonal rainfall estimates to accuracies of 10% to 20% could have been obtained for the 50 areas of interest. Had this resource not existed, it would have been very difficult to reach the objectives of this investigation. More study is needed to determine radar-rainfall accuracies on a daily basis.

The hydrogeologic component of this investigation made good use of the available data in assessing the impact of possible seeding-induced increases of precipitation on the water supply of Texas. Certainly nothing of this magnitude has ever been done before in the context of cloud seeding experiments. In view of the many acknowledged uncertainties only general guidelines were possible. It did, however, set the stage for further more focused research on a few hydrogeologic areas along the lines of those presented for the Edwards Aquifer rather than the "broad-brush" approach required for this study.

The design and cost estimates for a cloud seeding program over the portions of Texas that would possibly benefit from such a program make it obvious that cloud seeding is a complex and expensive business. Startup costs approaching \$19 million are envisioned with recurring annual costs of about \$7.5 million. The area in question is over twice the size of the combined current 10 seeding targets (i.e., 128 million acres vs. 56 million acres), and it is highly doubtful whether a doubling of the effort would be justified in view of the many current uncertainties and operational deficiencies. Not enough is known presently to warrant such a massive effort. Some have offered the same view with respect to the current operational seeding programs.

A major recommendation emanating from this study is that the current operational cloud seeding programs be evaluated for operational efficiency and enhanced rainfall before further augmenting the operational program. All readily understand the importance of evaluation of the seeding efforts. The Texas Weather Modification Association has mounted its evaluation effort, and the first author of this report and his colleague Dr. Daniel Rosenfeld have devised and are applying their own analysis approach to 2 of the 10 existing operational cloud seeding efforts. In principle, their approach can be extended to the entire program, provided a careful record of aircraft flight tracks and seeding actions is available. Although the "jury is still out" on attempts to make an unbiased evaluation of the operational cloud seeding programs of Texas, the initial results using the Woodley/Rosenfeld methodology are quite promising.

A second recommendation is that Texas finish what it started with respect to its randomized cloud seeding effort. Only 38 experimental units were obtained in the truncated program, and this is not enough by any measure to demonstrate an effect of seeding on an area basis. Instead, many of the key results that served as input to this study were obtained in a randomized experiment by the first author and his colleague in Thailand. Even then, the Thai experiment ended on schedule with highly positive but inconclusive results. Further, some will question the applicability of results obtained in Thailand to Texas.

Any new experimentation must have a strong physical component in which key measurements are made to understand how and why cloud seeding affects clouds that produce increased rainfall and those that do not. Furthermore, the efficacy of hygroscopic seeding (sprays and flares) should be tested in Texas. Positive results obtained in South Africa, Thailand and Mexico clearly warrant it.

Focused studies of the potential effect of cloud seeding on specific drainages and aquifers in Texas are also needed, and the Edwards Aquifer would be a great place to start. The current study made a nice start in this area, but it represents only a small beginning for what is a highly complex and intriguing investigation. Hydrologic computer models exist for most surface

drainage basins and are being developed for various aquifers. These should be applied to more accurately test hypothetical scenarios. The results should be integrated into cost-benefit analyses to determine which areas will likely receive the greatest benefit from seeding with the limited funds available. Further, analysis of additional seasons should be done to determine how strongly the input natural rainfalls influenced the results of the present study. Some areas that currently do not appear to be good candidates for cloud seeding intervention might look different under regimes of higher natural rainfall.

In the final analysis our recommendation is that political and scientific leadership in Texas work together to map out an all-inclusive program to investigate further the potential of cloud seeding for enhancing the water resources of the state. The tools and expertise exist; they just need to be put to work. When this is done, it is crucial that more effort be expended in documenting the effect of seeding as a function of area size under various weather conditions, and in validating the assumptions and in quantifying the impacts of the uncertainties inherent in the current study. Further, any future effort should be a partnership between scientific and operational interests with each sector providing needed input and expertise. The costs will be commensurate with the effort involved and certainly larger than what has been attempted heretofore in Texas.

1.0 INTRODUCTION

Since first appearing on earth, human beings have struggled to improve their environment for their welfare and comfort. Most of these have involved small-scale improvements, including the building, lighting, heating and cooling of homes and workplaces. In recent years such efforts have been extended to enormous sports facilities, allowing for the comfortable and protected viewing of sporting events. These efforts will continue as long as there is pleasure and profit to be gained by such changes.

Concurrent with attempts to improve the immediate living environment have been dreams and actions directed at beneficial alterations of the weather. Most have focused on the enhancement of precipitation or the suppression of hail, but they have been directed also at the suppression of lightning and the reduction of hurricane winds. Early attempts to bring about increased precipitation involved explosions and/or the production of smoke to simulate a battle scene, since a body of anecdotal "evidence" had accumulated over the years that heavy rains often followed large battles. There is no objective evidence, however, that such attempts increased the precipitation.

The modern era of weather modification began with the discovery of the ice nucleating properties of dry ice (Schaefer, 1946) and silver iodide (Vonnegut, 1947). The latter was effective as a seeding agent because of the similarity of its crystallographic structure to that of ice. The use of these agents in supercooled stratocumulus clouds produced seeding tracks in the clouds and light precipitation, which was viewed as proof that seeding had affected the clouds. Following these discoveries there was a proliferation of attempts to increase precipitation through cloud seeding, ranging from randomized research experiments to operational cloud seeding programs. These are summarized in Section 3.0 to provide the historical context for the evaluation of the potential of cloud seeding for Texas. It is important first, however, to understand the physics of clouds and precipitation and the physical principles behind attempts at their modification. Some of the information to be presented has been obtained from Grant et al. (1995), Brintjes et al. (2000) and other cited sources.

2.0 AN OVERVIEW OF THE PHYSICS OF CLOUDS AND PRECIPITATION

2.1 Cloud Formation

Clouds form when moist air rises and cools to the point where it can no longer hold the water in vapor form, since the ability of air to hold water decreases as the temperature decreases. At this point the air is saturated, where the temperature and dew point are equal and the relative humidity is 100%. Tiny cloud droplets a few microns in diameter (1 micron is one millionth of a meter) form and grow by condensation on dust and salt particles called cloud condensation nuclei (CCN). The end result is a visible cloud, which will grow further, if the mechanism forcing its growth continues. Under the right conditions the cloud droplets will grow more through collision and coalescence. If the air is cooled to temperatures well below 0°C, the excess moisture in the cloud can be deposited by a sublimation process directly on tiny particles called ice nuclei (IN). The temperature at which these IN nucleate ice is variable, depending on their size and chemical makeup. The nucleated ice particles can then grow by a number of processes,

including vapor deposition, riming and aggregation. All processes figure prominently in weather modification theory.

Many mechanisms can cause moist air to rise. It might be a mountain range that stands in the way of a moist current, forcing the air to rise to cross the barrier. Such orographic uplift results in the formation of clouds that shroud the mountaintops and ridges and in the enhancement of the precipitation relative to nearby valley areas. Fronts provide another means of lift, as the moist air glides up and over the more dense cooler air. This is why clouds and precipitation are associated with fronts. Even in the absence of fronts, convergence of air near the earth's surface will cause rising motion, because the converging air cannot penetrate downward into the earth's surface and, therefore, has no alternative but to rise. Dry lines, which are common to the Texas southern high plains in the spring and early summer, are hybrid systems that also produce convergence and rising motion, resulting in clouds and precipitation. Such lines have density contrasts but they are not fronts in the classic sense in that they represent a discontinuity in moisture content and not temperature. Simple heating of the earth's surface also produces rising motions, clouds and precipitation, especially during the summer months when the heating is intense and prolonged.

The stability of the air determines in large part the types of clouds and precipitation that will be produced by the forced rising motions. The atmosphere is said to be stable if a parcel of air returns to its previous equilibrium state after its forced displacement. Stable air moving across a mountain barrier in winter is a good example. Clouds and precipitation are produced by the orographic uplift despite the atmospheric stability. In contrast, air is said to be unstable when displacement of an air parcel results in even more displacement, sometimes through much of the troposphere. Large masses of cumulonimbus clouds and thunderstorms are a manifestation of an unstable atmosphere. Clouds under unstable or conditionally stable conditions produce much of the precipitation in Texas.

2.2 The Development of Cloud Condensates

The total amount of condensate produced in a rising air parcel is a function of the amount of water vapor in it initially, which in turn is a function of its initial temperature. How much of the water vapor is "squeezed out" depends on the depth of the lifting process and its final temperature --- the greater the depth the greater the produced condensate.

The growth of the droplets produced during cloud ascent determines whether the cloud will produce precipitation. If growth continues, the droplets may reach precipitation size before the cloud dies, and precipitation will be produced. If the cloud dies before its condensates can reach precipitation size, the cloud will not precipitate and the condensates will be lost ultimately to evaporation. The percentage of condensed water in a cloud that reaches the ground as precipitation is defined as the cloud's precipitation efficiency (PE) by Grant et al. (1995). Clouds that produce no precipitation have a PE of 0%. The challenge of cloud seeding is to increase a cloud's PE. If that is not feasible, it may be possible to increase precipitation by increasing the total amount of water vapor processed by the cloud, even though the PE is unchanged. Before getting into cloud seeding concepts and practice, however, it is crucial to understand natural processes.

Clouds of the same size often differ in the amount of rain they produce. This observation is not unique to meteorologists. The observant traveler knows by experience there are regional differences in the rainfall from clouds. Shallow innocuous clouds in the deep tropics often produce brief but torrential rain showers, while more ominous-looking clouds of comparable or greater depth in continental regions may not produce any rain showers. These regional differences in the rainfall from clouds have been quantified using volume-scan radar data to relate cloud echo heights to their volumetric rain production in Florida (Gagin et al., 1985; 1986) in Israel and South Africa (Rosenfeld and Gagin, 1989), and in Texas (Rosenfeld and Woodley, 1993).

The reasons for the regional differences in the rainfall from clouds are many and varied. A major factor is cloud microstructure, which leads to early precipitation formation in some clouds and no precipitation in others. As discussed earlier, cloud droplets nucleate on cloud condensation nuclei (CCN) and grow by condensation. However, this condensational growth alone is incapable of producing raindrops in clouds. The concentrations of cloud droplets are typically hundreds per cubic centimeter and the competition for the water vapor excess among the droplets is strong. This slows droplet growth, making it impossible for most clouds to develop drops of precipitation size during their lifetimes. Such clouds are colloidally stable and their PE is 0%.

One means for a cloud to overcome its colloidal stability involves direct collision and coalescence among the drops so that successively larger water drops form. This requires the coexistence of a few larger drops with many smaller ones such that their collision and coalescence is favored. The height above cloud base at which droplets finally reach precipitation size depends mainly on the initial drop size distribution (DSD) at cloud base, which in turn is a function of the CCN that are ingested and the cloud-base temperature. Therefore, the efficiency of the conversion of cloud water into precipitation depends strongly on the ingested CCN and on the resultant DSD and its evolution with height in the cloud. This is backed by model simulations, which show a strong link between CCN concentrations and the rainfall from clouds.

Some clouds do not produce precipitation by coalescence of liquid drops. If they extend through the 0°C level, where cloud water can remain in a supercooled state to nearly -38°C (Rosenfeld and Woodley, 2000), precipitation-size particles can be grown through ice processes. After initiation by ice nuclei (IN), tiny ice particles can grow to precipitation size as ice crystals by diffusion of water vapor to the surface of the ice particle or as graupel by collecting the supercooled cloud liquid water.

In many clouds both coalescence and ice processes are operative simultaneously in the production of precipitation. Such clouds are the most precipitation efficient. Raindrops are formed early and low in the cloud and, when they are carried above the freezing level, they freeze earlier than smaller drops and continue their growth as large graupel particles by collecting supercooled cloud droplets as they fall. Further, it also has been shown that, when some larger droplets (24 microns diameter) are present in the cloud in the temperature range from about -3°C to -8°C , ice crystals are multiplied by several orders of magnitude by a splintering process when the drops freeze. This process, which is typical in maritime clouds, can contribute to the formation of precipitation in clouds. Finally, aggregation of ice crystals is

another mechanism for the growth of cloud hydrometeors to precipitation size. This process is most typical at cloud temperatures less than -10°C , especially in the thick "anvil" cloud that forms and persists after intense convection.

The net effect of all of these processes is the growth of ice particles to precipitation size, usually as irregular graupel. This graupel melts when it falls below the freezing level and reaches the ground as rain. Which processes predominate on a given day will determine how readily the clouds precipitate.

With the above as background, it is obvious that clouds having large concentrations of small droplets and narrow droplet distributions will precipitate much less efficiently than clouds containing the same amount of water in fewer but larger drops in broad droplet distributions. In such clouds the drops cannot get large enough to grow by coalescence. The most important factors determining the cloud DSD are the updraft velocity at cloud base and on the CCN aerosols on which cloud droplets are formed. A major source of excessive concentrations of small CCN is air pollution, especially smoke from the burning of vegetation (i.e., biomass burning) or from heavy industrial areas. Therefore, clouds forming in a smoke-laden atmosphere usually are composed of numerous small droplets that may cause a reduction in the natural precipitation as shown by Rosenfeld and Lensky (1998). The irony here is that human beings are already altering the precipitation, but the alterations have been inadvertent and in the reverse sense than is desired.

2.3 Dynamic Factors

Dynamic cloud factors also enter into the precipitation equation. Without favorable dynamics that govern cloud circulations all attempts at rain enhancement will fail. On the other hand, if a cloud lives long enough, it can overcome almost all microphysical inefficiencies and produce precipitation. Doing this requires convective forcing. Clouds growing under mesoscale and/or synoptic forcing will have their lives prolonged and more readily precipitate after seeding than clouds growing in isolation without forcing.

3.0 PRECIPITATION AUGMENTATION CONCEPTS

It should be possible to increase precipitation through cloud seeding, if it is possible to shorten the time necessary for clouds to grow particles of precipitation size or if it is possible to prolong the lifetime of the cloud or both. The unique properties of water in its various forms and its behavior in clouds make both a possibility. These properties and behaviors include the following:

Water, existing in clouds as tiny droplets, does not freeze at the temperature people normally associate with the freezing of water (i.e., 0°C). This is due to a deficiency of natural ice nuclei. More are activated at progressively colder temperatures. In the extreme the cloud droplets may not freeze until they reach -38°C or colder (Rosenfeld and Woodley, 2000) with the freezing taking place homogeneously, that is, without the benefit of ice nuclei. An aircraft flying through such a cloud picks up a coating of ice when it impacts the supercooled drops,

which then freeze. Clouds that are already glaciated (i.e., frozen) will not ice up a penetrating aircraft.

The vapor pressure over an ice surface is lower than the vapor pressure over a water surface. Thus, in clouds with a mixture of ice crystals and water drops, the water vapor will move to the ice particles at the expense of the water drops. The ice particles grow as the water drops evaporate.

When water changes phase, heat is either released or taken away from the air parcel containing the water substance. When moist air condenses to form a cloud of water drops, the latent heat of condensation (597.3 calories per gram at 0°C) is given off to the cloudy air. When these drops are carried to colder temperature and then freeze to form ice particles, the latent heat of fusion (79.7 calories per gram at 0°C) is released to the cloudy air. Both transformations warm the cloud and increase its buoyancy, which may promote further cloud development. When the processes are reversed (i.e., melting to water and then evaporation to vapor), the cloudy air is cooled.

Clouds that develop larger drops earlier in their lifetimes precipitate more readily and produce more total rainfall than clouds that are not able to grow such drops. Further, clouds with active coalescence processes that result in early raindrop formation glaciate (i.e., freeze) earlier than clouds without raindrops.

With these facts as background, it is possible to develop precipitation augmentation concepts, which can be tested by randomized physical/statistical experimentation. This process has been underway for many years with varying degrees of success.

3.1 Cloud Seeding to Improve Precipitation Efficiency (PE)

When one understands the physics of natural rainfall involving ice processes as articulated first by Bergeron (1935) and Findeisen (1938), the challenge of augmenting that rainfall becomes conceptually simple. If the formation of ice particles in unseeded supercooled clouds promotes the development of precipitation, why not replicate this natural process by the seeding with an ice nucleant (e.g., silver iodide) in clouds that are unable to develop ice naturally? These seeding-induced ice particles would then grow at the expense of the water drops until large enough to fall from the cloud as precipitation. This is the “classic” seeding concept behind the earliest of seeding experiments and it is the basis of seeding programs around the world even today. This seeding approach was called “static seeding” in early years, because its intent is to improve precipitation efficiency without affecting the dynamics of the cloud system. If a cloud can be viewed as a sponge containing water, the purpose of “static” seeding is to squeeze more water from the sponge.

Calling this seeding approach “static seeding” is a misnomer, because it is not possible to produce the hypothesized microphysical changes in the clouds without changing their dynamics. If “static” seeding initiates and augments rainfall from clouds, their downdrafts are going to be affected. This is a dynamic effect, so “static” seeding affects cloud dynamics. Conversely, “dynamic seeding,” which is focused primarily on enhancing rainfall by altering the circulations

that sustain the clouds, can only attain its purpose by first producing changes in the cloud microphysical structure.

Seeding to improve the PE of cold clouds can be accomplished from the ground using silver iodide generators and in the air using either generators at cloud base or flares ejected into the cloud tops near -10°C . It is estimated that between 10 and 100 ice crystals per liter are needed to best utilize the cloud condensate for the production of precipitation. Because there is a one-to-one relationship between the number of ice crystals and the number of cloud nuclei in the absence of ice multiplication processes, this is accomplished with modern seeding generators and flares.

Depending on the cloud structure and temperature, the seeding will produce ice crystals and/or graupel in the cloud, which might grow by a number of processes (diffusion of water or accretion of supercooled liquid water or aggregation of ice crystals) to precipitation size. These will then reach the ground in solid or liquid form. Silverman (1986) addresses these seeding concepts in more detail.

In recent years there has been renewed interest in improving the efficiency of warm-cloud collision-coalescence processes through hygroscopic salt seeding. Two salt seeding methods are currently in use. One method applies hundreds of kilograms of salt particles (dry sizes are 10 microns to 30 microns in diameter) above cloud base to produce drizzle-size drops almost immediately (Silverman and Sukarnjanaset, 2000). The second method uses salt flares to disperse one micron or smaller size particles into updrafts near cloud base, a method which is currently receiving renewed interest in cloud seeding efforts (Tzivion et al., 1994; Mather et al., 1997; Cooper et al., 1997; Bigg, 1997). The salt material is released from kilogram size flares carried by aircraft; several flares are burned per cloud. The salt particles change the size distribution of the CCN in the updraft, creating a more maritime-type cloud. Coalescence is enhanced and raindrops form in the seeded volume, eventually spreading throughout the cloud. This accelerates the warm-rain process and makes it more efficient. In addition, if the updraft lifts the raindrops into the supercooled region, many of them will freeze and splinter, thereby enhancing the ice processes. This too makes the cloud more precipitation efficient. This method of seeding is thought to work best on continental-type clouds in which natural coalescence is weak or non-existent.

3.2 Cloud Seeding to Promote Cloud Growth

Besides increasing the PE, cloud seeding might also be used to promote the growth of clouds through the release of latent heat (80 calories per gram of water frozen) accompanying the rapid seeding-induced freezing of the supercooled cloud condensate and its subsequent growth as ice particles. This is the approach that has been developed by the senior author of this report for application in Florida, Texas and Thailand. For maximum effectiveness the seeding should be done in vigorous convective clouds having large quantities of supercooled condensate. An example of such a cloud is shown in Figure 1. Model simulations of cloud processes suggest that the seeding might increase cloud temperature by 0.5°C to 1.0°C and result in modest increases in cloud size. The warmed cloud air would then have increased buoyancy, resulting in an invigorated updraft, more cloud growth and potentially additional rainfall. This would occur

primarily in an atmosphere that is marginally stable such that the seeding-induced release of heat would promote the subsequent development of the cloud.



Figure 1. Picture of hard vigorous cloud towers at 1818 CDT on June 5, 2001 taken from 17,000 feet from “Cloud 2”, the Cessna 340 seeder of the High Plains operational cloud seeding project. The clouds shown were typical on this day.

These hypotheses evolved into a conceptual model that focused initially on the hypothesized dynamic invigoration of the cloud as a consequence of the released latent heats resulting from seeding-induced glaciation. It was argued that as a consequence of this invigoration, the cloud would grow taller and broader, last longer and produce more rainfall. The details of the microphysical processes were not addressed other than to require the seeding to produce more glaciation. It was even speculated that the seeding might decrease the PE in the seeded volume but that the great increase in cloud size and duration would more than compensate for the momentary microphysical inefficiencies. The seeding was viewed as a trigger that would set in motion natural processes that would account for the increased rainfall. This conceptual model became known as the dynamic seeding conceptual model, although the effects of the seeding are not limited to cloud dynamics. In fact, the effects of seeding begin with microphysical changes (i.e., freezing of the condensate, the formation of ice particles, etc.) that ultimately affect cloud dynamics.

During the development of this conceptual model, Simpson (1980) argued persuasively for downdrafts as the mechanism whereby a seeded cell might communicate to the larger scales by generating new clouds and cloud mergers in the convergent regions between storm outflows and the ambient flow.

Early in the Texas experimentation it was argued (Rosenfeld and Woodley, 1993) that the seeding-induced increases in precipitation from cells were larger than could be explained simply by the increase in cell height, as estimated from echo height vs. rain volume relationships. They argued that the seeded clouds must actually be more precipitation-efficient, if the cell rainfall results were to be explained. The finding that seeded clouds of a given echo height produce more rainfall than non-seeded clouds of the same echo height (Rosenfeld and Woodley, 1993) supported their contention. Further, the argument for more microphysically efficient seeded clouds was consistent with Simpson's arguments regarding downdrafts, because more efficient clouds should produce additional rainfall and stronger downdrafts. These interactions culminated in the revised cold-cloud seeding conceptual model (Rosenfeld and Woodley, 1993), which places more emphasis on cloud microphysical processes and their feedback to cloud dynamics than the earlier model (Woodley et al., 1982).

This conceptual model involved a hypothesized series of events beginning initially on the scale of individual treated clouds or cells and cascading ultimately to the scale of clusters of clouds. This seeding is hypothesized to produce rapid glaciation of the supercooled cloud liquid water content (SLWC) in the updraft by freezing preferentially the largest drops so they can rime the rest of the cloud water into graupel. This seeding-induced graupel is postulated to grow much faster than raindrops of the same mass so that a larger fraction of the cloud water is converted into precipitation before being lost to other processes. Ice multiplication is not viewed as a significant factor until most of the cloud water has been converted into precipitation. This faster conversion of cloud water into ice precipitation enhances the release of latent heat, increases cloud buoyancy, invigorates the updraft, and acts to spur additional cloud growth and/or support the growing ice hydrometeors produced by the seeding (Rosenfeld and Woodley, 1993). These processes result in increased precipitation and stronger downdrafts from the seeded cloud and increased rainfall in the unit overall through downdraft interactions between groups of seeded and non-seeded clouds, which enhance their growth and merger (Rosenfeld and Woodley, 1993). "Secondary seeding," whereby non-seeded clouds ingest ice nuclei and ice crystals produced by earlier seedings, is thought also to play a role in the precipitation enhancements.

A summary of this conceptual model, revised further as of June 1999, is provided in Figure 2 below. Validation of this model using recent observations and modeling is discussed later in this report.

Figure 2

Idealized Cold-Cloud Conceptual Seeding Model

(Revised in June 1999)

Optimum Initial Conditions

1. Vigorous supercooled clouds with some coalescence, growing in close association with other clouds of similar characteristics.
2. Strong solar heating.
3. Little upper cloud.
4. Strong boundary layer forcing
5. Middle and upper troposphere stratified to allow for seeding-induced vertical cloud growth.
6. Weak to moderate wind shear at and above the level of seeding (about -8°C)

Seeded Stage I: Initial Response to Seeding

1. On-top seeding with ejectable AgI flares with the number a function of the cloud cross-section (typically an average of five 20-g flares).
2. Rapid glaciation of the supercooled cloud liquid water content (SLWC) in the updraft by freezing preferentially the largest drops so they can rime the rest of the cloud water into graupel (A few large raindrops are necessary for optimum rapid freezing.)
3. The seeding induced graupel grows faster than raindrops of the same mass so that a larger fraction of the SLWC is converted into precipitation before being lost to other processes
4. Ice multiplication is not a factor until most of the SLWC has been converted to precipitation
5. Release of latent heat (fusion and sometimes deposition), increased cloud buoyancy, invigorated updraft
6. Increased cloud growth and/or support of the growing ice hydrometeors produced by the seeding
7. Dynamic entrainment of drier environmental air just below the invigorated rising tower
8. Evaporation and melting of water and ice falling from the invigorated cloud tower into the entrained dry air
9. Accelerated and strengthened downdraft processes as the precipitation mass and evaporatively cooled air moves down through the cloud
10. Increased precipitation beneath the seeded cloud tower

Seeded Stage II: Communication of Seeding Effects within the Seeded Cloud

11. Increased convergence at the interface between the augmented downdraft and the ambient flow, instigating tower ascent fed by the warm moist inflow
12. Growth and joining of new cloud towers and expansion of the cloud system, leading to wider protected updrafts, augmented condensation and water content
13. More efficient processing of the ingested water
14. Secondary seeding of new cloud towers with precipitation embryos from originally seeded cloud towers
15. Augmented rainfall from the cloud system

Seeded Stage III: Communication of Seeding Effects to Neighboring Clouds

16. Intensification and expansion of downdrafts from seeded neighboring clouds
17. Growth of new clouds in convergent regions produced by interacting downdrafts, forming a cloud bridge between the parent clouds
18. Merger of the parent clouds resulting (on average) in an order of magnitude more rainfall than would have been produced by the components of the merger had they remained separate
19. Formation of a large cumulonimbus system

Seeded Stage IV: Communication of Seeding Effects to the Entire Unit

20. Propagation and interaction of downdrafts from the seeded cloud systems with non-seeded clouds
21. Increased convergence on the mesoscale, further deepening of the moist layer, continued growth of new clouds which were never seeded
22. Second order mergers (i.e., merger of mergers) producing an additional order of magnitude increase in rainfall
23. Secondary seeding (i.e., ingestion of ice nuclei and/or ice particles from seeded clouds) of non-seeded clouds
24. Formation of a thermally direct mesoscale circulation with rising motion within the cloud system and sinking on its periphery
25. Additional mass and moisture convergence which fuels new cloud development and prolongs the lives of the older cloud systems
26. Enhanced stratiform ("anvil") rainfall
27. Increased unit rainfall

This is a complicated conceptual seeding model, which serves to emphasize the complexity of atmospheric processes and their potential alteration by seeding. Attempts to validate some of the links in the conceptual chain are addressed later in the report.

4.0 LAY PERSON'S GUIDE TO IMPORTANT ISSUES OF RELEVANCE TO CLOUD SEEDING FOR RAIN ENHANCEMENT

4.1 Need for Pre-Experiment Measurements

Seeding experiments begin with a conceptual model of the sequence of meteorological events to be expected after seeding, leading ultimately to increased precipitation. This is followed by a systematic program of measurement using aircraft, radar and satellites to determine whether the clouds in the projected target area have the characteristics assumed by the conceptual model. If the model requires vigorous supercooled convective clouds before seeding, but the results of the pre-experiment measurement program indicate that such clouds are usually glaciated, there would be no point in proceeding with the cloud seeding experiment. In most regions it is usually not an either-or situation. The clouds might be suitable on some days but unsuitable on others. The challenge, therefore, is to identify which situation prevails before seeding begins. Failing that, it is important to determine after-the-fact the conditions prevailing on each day of seeding. Much more will be said about this later in this report.

4.2 Selection of a Design

The pre-experiment measurements are followed by the selection of a design (e.g., crossover, target-control and single target) by which the efficacy of the seeding in increasing precipitation is to be tested. The crossover design involves two targets with a buffer zone between them. On each day of suitable conditions a treatment decision, which specifies which target is to be seeded and which is to be left untreated, is drawn from a randomized sequence. The experiment then proceeds according to the randomized instructions. The evaluation of the crossover experiment is made by forming the double ratio: $R1S/R2NS//R1NS/R2S$ where $R1S$ and $R1NS$ refers to the rainfall (R) in Target 1 when it was seeded (S) and not seeded (NS), respectively, and $R2S$ and $R2NS$ refers to the rainfall (R) in Target 2 when it was seeded (S) and not-seeded (NS), respectively.

The crossover design is the most efficient in that it that it normally allows the experimenters to reach a decision as to the efficacy of seeding in the shortest possible time. It only works, however, if the rainfalls in the two targets are highly correlated (i.e., correlation > 0.70). Two such areas are not possible in Texas since the seeding tests are usually conducted on days with scattered to widely scattered convection. Under such conditions, the correlations of area rainfall amounts are too small for the crossover design.

A second alternative is the target-control experiment. With this design the treatment decision is randomized for the target (i.e., S or NS) and the upwind control is never seeded. The evaluation of the target-control experiment is done by forming the double ratio: $RS/CS//RNS/CNS$ where RS and RNS refer to the target rainfall on S and NS days, respectively, and CS and CNS refer to the rainfall in the control area on S and NS days, respectively. The

control area is never seeded. Thus, the control area serves to detect biases on the S and NS days and this mean bias in the form of the ratio CS/CNS is used to correct for what is assumed to be a corresponding bias in the target. Again, the utility of this approach depends on a strong correlation between the rainfall in the target and the rainfall in the upwind control area. Such correlations normally do not exist in convective regimes such as those in Texas. Only when the precipitation is widespread does this approach have any potential.

The third alternative is the single target design for which the treatment decision is randomized (i.e., either S or NS). The single target can be fixed to the earth or it can drift with the wind. The Florida experiments to be discussed later employed a large ($1.3 \times 10^4 \text{ km}^2$) fixed target while the Texas and Thai experiments made use of a much smaller floating target ($1.964 \times 10^3 \text{ km}^2$). This design is the least efficient, because only one target rainfall measurement is made on each day of experimentation, whereas two are made with the other designs on each day (one for each target with the crossover design and one for the target and one for the control area with the target-control design). Despite its limitations, the single target design is the only one that is possible for convective cloud seeding experiments in Texas.

4.3 Randomization

After the selection of a design the next step is treatment randomization. This is done to avoid the possibility of human bias in the selection of the treatment decision. Further, randomization, if employed for many cases, is useful in minimizing the possibility of natural rainfall bias confounding the interpretation of the experiment. A 50-50 randomization for the S and NS treatment decisions is typical, but it is not a requirement. The randomization can be weighted in favor of a particular treatment decision (e.g., 70-30 in favor of the S decision) if more seeding events are needed. Randomization can also be done within blocks. In the Thai experiment to be discussed later, the randomization was done within two cloud-temperature blocks. The first block was employed on days when the cloud-base temperature was $\leq 16^\circ\text{C}$ and the second block was used when the cloud-base temperature was $> 16^\circ\text{C}$.

Operational cloud seeding efforts are rarely randomized, because the organizations paying for the seeding activity typically do not want to leave any suitable cloud unseeded, so it can be used as a control. This is unfortunate because the evaluation of a seeding effort is extremely difficult without the benefit of randomized controls.

When randomization is employed it is desirable, but not absolutely necessary, to keep the treatment decision from those conducting and evaluating the experiment. This is called the "double-blind" approach that is often used in medical trials. The double-blind approach was used in the Florida experiments, because those sponsoring and supporting the experiments were willing to purchase placebo flares for use on days without actual seeding. The seeder aircraft carried both silver iodide (AgI) and placebo flares in racks affixed to the aircraft, and the randomization determined which rack was to be used. Because the placebo flares sounded just like the actual seeding flares when they left the aircraft, the individual directing the seeding (Woodley) did not know whether he was actually seeding. Further, he did not have the treatment decisions until after he had done the analysis.

In the Texas and Thai experiments, however, no provision was made for the use of placebo flares. Thus, although the selection of an experimental unit was not biased by a fore knowledge of the upcoming treatment decision, one could argue that the conduct of the experiment and its subsequent evaluation could have been biased once the treatment decision was known.

4.4 Types of Experiments

There are several types of experiments. The most powerful and persuasive is one in which the design, conduct and evaluation of the experiment is specified beforehand (i.e., *a priori*, which is Latin for before the fact). Then everything is done according to the *a priori* design and the results of the experiment are evaluated, where a P value of 5% normally is deemed necessary to achieve statistical significance. "P-values" refer to the results of statistical tests where a P-value is the probability that a particular result could have occurred by chance. The lower the P-value the higher the significance of the result and the lower the probability it could have occurred by chance.

If the intent of a particular experiment is to confirm the results obtained by seeding obtained elsewhere in the world, it should attempt to duplicate all that was done in that experiment. Further, it should state what is to be done beforehand. When this is done, the experiment becomes an *a priori* confirmatory experiment. If completed successfully with P values < 0.05 , it would be a powerful result.

Experiments whose designs and execution change during the course of the experiment are considered exploratory. Likewise, experiments that achieve P values < 0.05 for analyses of seeding effects not specified in advance of the experimentation are also considered exploratory. Most experiments fall into this category. An exploratory experiment deemed successful on the basis of its P values is still not as powerful and persuasive as the *a priori* experiment. The only way to solidify the results from an exploratory experiment is to confirm them with an *a priori* experiment, either in the same area or in another part of the world.

4.5 Conduct of the Experiment

The biggest problem in the conduct of an experiment is delivering the nucleant to the clouds at the times and places it is needed. If individual clouds are to be seeded and evaluated, the nucleant must be introduced when the cloud is in its active growth phase as shown in Figure 1. If seeding takes place late in the life of the cloud, the hypothesized changes are not likely to take place, not necessarily because the conceptual model is faulty but because the execution of the experiment is flawed. Likewise, if groups of clouds are to be seeded over either a fixed or floating target area, many clouds actually must be seeded in a timely fashion in order to enhance the rainfall over that area. Despite the best of intentions, this is often not achieved, and it is a major obstacle to the success of a seeding experiment. Rainfall cannot be enhanced unless the clouds are seeded at the time and in the manner assumed by the conceptual model that is guiding the experimentation.

A good example of this problem comes from past seeding experiments in mountainous regions using seeding generators placed on the upwind side of the mountains. In some programs some of these generators were placed in the upwind valleys and much of the nucleant was trapped beneath low-level temperature inversions and never found its way to the target clouds. Obviously, no seeding effect is possible under such circumstances.

Even if the nucleant is delivered to the clouds properly, it is always possible that the seeding devices will fail in the clouds. This was the case during a portion of the Thai experiment when it was determined that during the middle portion of the experiment about 45% of the seeding flares failed to ignite after release from the seeder aircraft. This was likely detrimental to the experiment, but quantification of this problem has not been possible. Such problems, which may have occurred also in FACE-2, add to the uncertainty surrounding cloud seeding.

4.6 Estimation of Target Rainfalls

A major challenge in all rain enhancement experiments is the estimation of target rainfalls. The word "estimation" is used rather than "measurement," because there is no way to measure rainfall with absolute accuracy, especially convective rainfall that by its very nature has strong cores and gradients.

Radar is the preferred tool for the estimation of rainfall in cloud seeding experiments. Radars measure a quantity called "reflectivity" (Z) and these reflectivity measurements are converted to rainfall rates using Z - R equations, which depend on the drop sizes in the clouds. If the scanned clouds contain drop sizes that are different from those that went into the derivation of the equation, the radar is going to make errors in estimating the precipitation. Further, if the clouds of interest do not fill the radar beam, their rainfall also will be underestimated.

Such problems are not likely to engender much confidence in the radar estimation of rainfall. Fortunately, the interest in cloud seeding experiments is in the ratio of S to NS rainfalls. Thus, if the radar errors apply equally well to the S and NS clouds, the estimate of seeding effect should be unaffected by the errors. If on the other hand, the radar under or overestimates the rainfall from the S clouds relative to the NS clouds, the apparent seeding effect may be spurious, due not to the seeding but to radar errors.

The possibility that the radar "sees" S and NS clouds differently was investigated during the Florida experiments by measuring the droplet sizes in rainfall from S and NS clouds. No differences in drop sizes were detected (Cunning, 1976). Thus, the radar estimate of seeding effect should still be valid.

The absolute amount of rainfall to be realized from seeding is still in question, however, because of evaporative losses in the drier air beneath the clouds. The only way this can be estimated is through comparison of the radar rainfall estimates with the measurement of rainfall by rain gauges in clusters or small arrays. Such comparisons will allow for adjustment of the radar rainfall estimates everywhere within scan of the radar. With such a system the estimates should be better than those provided by radar or rain gauges alone. This issue is revisited later in this report.

4.7 Evaluation of the Experiment

The evaluation phase of an experiment focuses on the results of the seeding. Even if the conceptual model is valid and even if the seeding was conducted properly, there is still no guarantee of success. Only if the natural rainfall variability can be overcome will it be possible to detect a seeding effect. Even the non-meteorologist understands that natural rainfall is highly variable in space and time and that it can mask an effect of seeding.

In theory, randomization of the treatment decision should take care of the natural rainfall variability. If the experiment goes on long enough, it is theorized that an equal percentage of the naturally wet and dry days will be apportioned randomly to seeding and controls (i.e., not seeded). If so, the mean rainfall differences between the seeded and non-seeded storms should be a measure of the effect of seeding. If this is not so, the mean rainfall differences might be due to the disproportionate random allocation of wet or dry days to either the seeded or not seeded categories.

There are two ways to beat this unwanted outcome. The first is to conduct the experiments for long periods to insure that the allocation of rain events is not biased. The second is to come up with a way to make accurate forecasts of rainfall in the target in the absence of seeding. If this were possible, the evaluation of a seeding experiment would be trivial. One would predict the target rainfall in the absence of seeding and then measure what actually occurred, secure in the knowledge that the difference between measured and predicted rainfall is due to the seeding. Unfortunately, this is not yet possible in the evaluation of seeding experiments, and it explains the continuing uncertainty over the results of cloud seeding.

An ideal experiment is one in which the treatment decision is not known to the individuals conducting and evaluating the experiment. This ideal is rarely achieved, however, because of the complexity and cost involved. Thus, human bias also is a potential problem in the evaluation of cloud seeding experiments, and care must be exercised to avoid it. Independent evaluation of experiments by highly competent but disinterested scientists is another way to minimize the effect of human bias on experiments. Suffice it to say that it is far easier to address this potential problem than it is to address the bias that results from the natural rainfall variability.

5.0 ASSESSMENT OF PRECIPITATION ENHANCEMENT EXPERIMENTS

5.1 Worldwide Overview

The number of worldwide seeding projects for precipitation enhancement and hail suppression since 1950 is in the hundreds. The interest here is in precipitation enhancement projects. Most of these programs have involved operational cloud seeding. Typically, they were evaluated using historical target vs. control relationships. Unfortunately, Gabriel and Petrondas (1983) have shown that reliable conclusions cannot be drawn from comparisons of operational data with historical records, and have demonstrated the biases encountered in trying to do so. Thus, the results of these operational projects were not weighted very heavily in assessing the status of cloud seeding for precipitation enhancement. The focus here is on projects that have employed

randomization of the treatment decision. A sampling of such projects around the world is provided in Table 1. Listed from left to right are the project location and its focus. The next three columns give the results and the P-value support for the result for *a priori* projects, for *a priori* confirmatory projects, and for projects deemed exploratory either because they were not designed as *a priori* efforts or because changes in the conduct of the experiments or their evaluation were changed after project commencement. Most projects fit into this last category.

In some cases the evidence is confusing and contradictory. Some projects apparently produced statistically significant precipitation increases; others did not. Some even appeared to have decreased the rainfall despite intentions to the contrary. The clear message here is that cloud seeding for precipitation enhancement is a complex business. In order to avoid unintended consequences, it is crucial that cloud seeding efforts be based on sound physics and that they have good designs and evaluations.

It is beyond the purview of this research effort to provide a worldwide assessment of precipitation enhancement projects other than to draw attention to the more important programs. Such evaluations have been done by distinguished scientific panels in various organizations over the years. Excerpts from the "official" views of the status of weather modification by the American Society of Civil Engineers, the Weather Modification Association, the American Meteorological Society, and the World Meteorological Organization are provided in Appendix A. Although the details differ from assessment to assessment, there is a general consensus that cloud seeding to enhance precipitation works under some conditions and produces no effect or even a negative effect under other conditions. The evidence is strongest for the seeding of individual clouds and weakest for area precipitation. For example, it should be noted that no *a priori* project, involving the seeding of warm season convective clouds over a fixed or floating target area has achieved statistical significance.

The next two subsections take a closer look at the status of the seeding of orographic and convective clouds, respectively. Some of the cited seeding efforts are listed in Table 1. Others are listed for Australia (Smith, 1963), Missouri (Braham, 1996), Arizona (Battan, 1966), Mexico (Betancourt, 1966) and Montana (Super, 1983) without comment. Because the seeding of convective clouds using a dynamic approach is to be employed for rain enhancement in Texas, the results of past experiments making use of this approach receive closer scrutiny than the rest. This is done in Table 2. The venerable Israeli series of cloud seeding experiments are examined in considerable detail in the section dealing with the uncertainty surrounding cloud seeding programs.

5.2 Overview for Orographic Clouds

After the initial experiments in the 1940's by Schaefer and Vonnegut at the General Electric Laboratories under the direction of Nobel Laureate Irving Langmuir there were several weather modification projects that suggested seeding had enhanced the winter snowpack in the mountains of the West (Elliott, 1986). These and subsequent orographic seeding experiments typically involved the release from ground generators or from aircraft of silver iodide nuclei upwind of a mountain barrier into the region of the orographic cloud containing supercooled

water. If accomplished successfully, it was expected this would result in the nucleation, growth and fallout of ice crystals before the cloud moved across the barrier and evaporated.

Table 1 Summary of Important Randomized Cloud Seeding Experiments

Project Location	Project Focus	Type of Experiment		
		<i>A priori</i> Result, P value	<i>a priori, confirm</i> Result, P value	Exploratory Result, P value
New South Wales, Australia	Precipitation in Snowy Mountains	None	None	+19%, 0.03
Israel I (crossover)	Rainfall in both targets	+15%, 0.009	None	
Israel II (target-control)	Rainfall in north target	None	None	+13%, 0.028
Israel II (crossover)	Rainfall in both targets	None	-2%, 0.64	
Israel II (target-control N and S)	Rainfall in the N and S targets	None	None	+15%N, 0.17 - 17%S, 0.15
Israel III	Rainfall in both targets	None	-4.5%, 0.64	
Climax I	Rainfall in target	None	None	+52%, 0.03
Climax II	Rainfall in target	None	+9%, 0.02	
Bridger Mountains, Montana	Snow in target	None	None	+15%, 0.02
Veracruz, Mexico	Rain over three targets	None	None	+14%, 0.03
Santa Catalina Mts. Arizona	Rain over target	None	None	-30%, 0.16
Missouri	Rain over target for deep clouds	None	None	-69%, 0.03
Missouri	Rain over target for shallow clouds	None	None	+100%, 0.02

A series of Australian randomized crossover experiments in the 1950's and early 1960's gave promising, but not statistically significant, results after two years. However, after an extension of the effort for four to five years, a steadily decreasing ratio of seeded to unseeded rainfall was indicated (Dennis, 1980). Bowen (1966) hypothesized that this strange result was due to a carry-over effect such that the distinction between seed and no-seed days became obscured after one or two years. To counteract this hypothesized effect a Tasmanian Project, which used control areas that were never seeded, was operated on even numbered years from 1964 to 1970 (Smith et al., 1971; Smith, 1974). The results were comparatively uniform on each of the seeded years. The evidence of rainfall increases of 15 to 20% during the autumn and winter seasons agreed with the early Australian results, and no detectable increases during the summer season was also in accord with previous Australian results (Dennis, 1980).

The well known randomized snowfall enhancement seeding projects, Climax I (1960-1965) and Climax II (1965-1970), were carried out in the Colorado Rockies near the town of

Climax. Areas near the Continental Divide were seeded by silver iodide generators, which were operated high on the western slopes of the Rocky Mountains. One of the most important results of Climax I was the finding that snowfall was increased when the ambient 500 mb temperature was warmer than -25°C and decreased at colder temperatures (Mielke et al., 1970). For the similar follow up project called Climax II, Mielke et al. (1971) presented results that essentially confirmed the findings for Climax I. However, reanalyses of the Climax data reported by Rangno and Hobbs (1987; 1993) cast doubt on the original findings regarding the effectiveness of the cloud seeding.

The Colorado River Basin Pilot Project (CRBPP) was another randomized follow up project to the Climax experiments (Cooper and Saunders, 1980; Cooper and Marwitz, 1980). The results of the CRBPP indicated that the best candidate for seeding is the unstable stage of a wintertime storm because this portion of the storm has the highest liquid water content along with portions that have low ice concentrations. Seeding these regions should result in snow increases.

The Sierra Cooperative Pilot Project (SCPP) took a physical approach to cloud seeding experiments by emphasizing physical understanding and the documentation of the chain of events in both natural and artificially-stimulated precipitation processes (Marwitz, 1986). One of the most important results of the project was that shallow widespread wintertime orographic cloud systems, containing long-lasting supercooled cloud liquid water, provided the best potential for precipitation augmentation through cloud seeding operations. These findings were then applied in a seeding project in the upper elevations of the American River Basin with the aim of increasing precipitation and the subsequent runoff.

Research to determine the potential for increased winter season precipitation through cloud seeding has continued in the following projects: 1) the Bridger Range of Montana (Super and Heimbach, 1988), 2) the Arizona Snowpack Augmentation Program (Super et al., 1989; Brintjes et al., 1994), 3) the Australian Winter Storms Experiment (Long and Huggins, 1992) and 4) the Utah-NOAA cooperative weather modification field campaigns (Sassen and Zhao, 1993). All of these projects are consistent in showing that supercooled liquid water exists in at least a portion of their storms and that the supercooled liquid water is concentrated in the low layers of the storms in shallow clouds with warm tops. It has also been determined that a large amount of supercooled liquid water typically passes over the mountain barriers on a seasonal basis. This implies considerable seeding potential, provided a portion of the excess supercooled water could be brought to the surface through cloud seeding.

5.3 Overview for Convective Clouds

A number of experiments focused on warm-season convective clouds followed the initial seeding experiments of the late 1940's. Some focused on rain augmentation by improving the efficiency of the precipitation processes. Others focused on manipulating cloud dynamics by producing rapid glaciation. Still others attempted to document the changes in the clouds produced by the seeding.

In the first category, the Rapid Project in western South Dakota from 1966 to 1969 made use of ground-based and aircraft releases of silver iodide and dry ice in a crossover design to affect cloud microphysical processes, improve precipitation efficiency, and increase the precipitation. This was the first randomized project in the United States to give indications of rainfall increases over a fixed target area by seeding convective clouds on a prespecified class of days. Further similar work in North Dakota did not provide statistically significant results (Dennis et al., 1975). Previous work in Arizona (Battan and Kassander, 1960) and Missouri (Braham, 1979) failed to produce evidence of rainfall increases, and may have produced net rainfall decreases. The distinctive feature of the Missouri program called "Whitetop" was the release of silver iodide in the boundary layer in the morning before convective clouds had formed. This was apparently not a good seeding strategy.

Experimentation in wintertime convective clouds in Israel since the mid 1960's has indicated net increases in precipitation (Gagin and Neuman, 1974; 1981). Israel 1 was a target-control experiment conducted in the north of Israel, while Israel 2 was designed as both a target-control and a crossover. Israel 1 was statistically significant as was the target-control portion of Israel 2, but the crossover was not. Indications of rainfall increases were noted in the north but no effect or even decreases were indicated in the south target. Israel 3 confirmed the decreases in the south target and all operational seeding was subsequently terminated in this area. Rosenfeld and Farbstein (1992) have postulated that incursions of desert dust during seeding in the south are responsible for the apparent rainfall decreases. Because the desert dust can act as ice nuclei, it is thought that the rainfall decreases from seeding during dust episodes were due to an excess of ice nuclei (i.e., overseeding). Recent criticism of the Israeli experiments by Rangno and Hobbs (1995, 1997) has raised some doubts concerning the analysis and operations.

Experiments on warm-season convective clouds to affect cloud dynamics began with the well-known seeding with 136 kg of powdered dry ice of an individual supercooled convective cloud in Australia (Kraus and Squires (1947). The seeded cloud developed into a large cumulonimbus cloud, producing over 12 mm of rain over a 130-km² area. This was followed by a series of experiments on individual convective clouds, beginning over the Caribbean in the 1960's and continuing in Florida, Texas, South Africa, Cuba and Thailand. Most of these experiments were focused on altering cloud dynamics. Many have indicated increases in cloud height and/or increases in rainfall over the Caribbean (Simpson et al., 1967, Florida (Simpson and Woodley, 1971; Gagin et al., 1986), Texas (Rosenfeld and Woodley, 1993; Woodley and Rosenfeld, 1996), Cuba (Koloskov et al., 1996) and Thailand (Woodley et al., 1999).

In addition, renewed interest in hygroscopic seeding of individual convective clouds, aimed at improving their precipitation efficiency by enhancing the coalescence process, has resulted in experiments that have produced positive results. Randomized experiments in South Africa (Mather et al., 1997) using hygroscopic flares and in Thailand (Silverman and Sukarnjanaset, 1999) using bulk salts have produced statistically significant increases in radar-estimated rainfall from the seeded clouds, ranging from 30% to 60%. Numerical simulation of the growth of the salt particles to precipitation size particles support the field results (Cooper et al., 1997). Most impressive has been the replication of the South African results in Mexico (Bruitjes et al., 1998). The method, involving the production of hygroscopic salts from burning

flares affixed to the seeder aircraft circling in updrafts at cloud base, has not yet been tested over a large area.

If the seeding of warm-season convective clouds is to prove economically feasible, it must be demonstrated over a large area. This is not a new revelation and experiments over the years have been directed at documenting area effects of seeding. These are addressed in the next section addressing the results of experimentation of most relevance to Texas.

5.4 Results of Relevance to Texas

The current Texas operational cloud seeding program has a long ancestry of experiments. These are discussed in more detail than in the previous section in order to lay the groundwork for the assessment of the potential of cloud seeding as a water management tool for Texas. The current operational seeding programs are employing techniques and concepts that were learned from these research experiments and, therefore, are most relevant to Texas.

The results to be discussed are presented in summary form in Table 2, including all known randomized Texas seeding experimentation. Project location and the parameter of interest in the experiment are noted first. These are followed by columns identifying the type of experiment where column 1 refers to experiments that were conducted according to an "*a priori*" design, 2 refers to *a priori* experiments that were also were attempts to confirm previous findings and 3 refers to experiments that are viewed as exploratory, because the conduct and/or analysis of the experiment differed in some way from what was specified in advance. Within these last three columns are listed the result for the parameter of interest and the corresponding P value.

The randomized cold-cloud seeding experiments, which began over the Caribbean Sea (Simpson et al., 1967) and were moved to Florida (Simpson and Woodley, 1971) and then to Texas (Rosenfeld and Woodley, 1993), continued in Thailand until scheduled program termination at the end of the 1998 season. The early experiments focused on the response of vigorous, individual, supercooled clouds to on-top seeding with silver iodide (AgI) free-fall rockets and flares. On average the seeded clouds grew about 20% taller (Simpson et al., 1967; Simpson and Woodley, 1971) as measured by aircraft and produced > 100% more radar-estimated rainfall than comparable non-seeded clouds (Simpson and Woodley, 1971). All results are significant at better than the 5% level.

The next step involved area-wide experimentation in Florida. The first Florida Area Cumulus Experiment (FACE-1) was carried out in south Florida from 1970-1976 (Woodley et al., 1982). It was a single-area, randomized, exploratory experiment to investigate whether seeding convective clouds according to the dynamic-mode seeding concept could enhance precipitation over a substantial area covering 1.3×10^4 km². Seeding was accomplished from three aircraft dropping pyrotechnic flares of 50-70 g each into the tops of convective towers which satisfied both visual and measurement criteria. The primary response variables were rain-gauge-adjusted, radar-estimates of rainfall in the total target (TT) and in the floating target (FT), the most intensely treated portion of the target. During the course of the experiment a number of important design changes were made, some based on economic necessity and some as a result of new information.

**Table 2 Summary of the Results of Experiments of Relevance to Texas
(All but the Nelspruit, South African experiment made use of AgI.
Dry Ice was used in the South African experiment)**

Project Location	Parameter of Interest	Type of Experiment		
		<i>A priori</i> Result, P value	<i>a priori</i> , confirm Result, P value	Exploratory Result, P value
Caribbean	Cloud Height	None	None	+22%, 0.01
Florida 1968	Cloud Height	None	+11,400 ft, 0.005	None
Florida 1968	Cloud Rainfall	None	None	+116%, 0.20
Florida 1970	Cloud Height	None	+6,200 ft, 0.01	None
Florida 1970	Cloud Rainfall	None	+180%, 0.05	None
Florida, 1971-1976 (All Days)	Floating Target Rainfall	+46%, 0.03	None	None
Florida, 1971-1976 (All Days)	Target Rainfall	+29%, 0.05	None	None
Florida, 1971-1976 (B days only)	Floating Target Rainfall	None	None	+49%, 0.01
Florida, 1971-1976 (B days only)	Target Rainfall	None	None	+23%, 0.08
Florida, 1971-1976 (B days only)	Floating Target (linear analysis of covariance)	None	None	+58%, 0.02 (From Woodley et al., 1982)
Florida, 1971-1976 (B days only)	Total Target (linear analysis of covariance)	None	None	+33%, 0.02 (From Woodley et al., 1982)
Florida, 1971-1976 (B days only)	Total Target (guided exploratory linear modeling)	None	None	+30 to 45%, ≤ 0.05 (From Flueck et al., 1986)
Florida, 1978-1980 (All days)	Floating Target Rainfall	None	+21%, 0.30	None
Florida, 1978-1980 (All days)	Total Target Rainfall	None	+3%, 0.45	None
Florida, 1978-1980 (B days only)	Floating Target Rainfall	None	+8%, 0.42	None
Florida, 1978-1980 (B days only)	Target Rainfall	None	+4%, 0.45	None
Florida, 1978-1980 (B days only)	Total Target (guided exploratory linear modeling)	None	None	+10 to 15%, > 0.05 (From Flueck et al., 1986)
Texas, 1986-1994 (intermittent)	Echo Height	None	None	+10%, 0.21
Texas, 1986-1994 (intermittent)	Cell Rainfall	None	None	+163%, 0.01
Texas, 1986-1994 (intermittent)	Target Rainfall	None	None	+45%, 0.16
Nelspruit, South Africa, 1984/1985 to 1986/1987 seasons	Rain mass with height of cloud turrets on flanks of multicellular storms	None	None	+129% and +66% for 0-10 and 10-20 periods, $p < 0.05$ -57% for 20-30 period, $p < 0.05$

Nelspruit, South Africa, 1984/1985 to 1986/1987 seasons	Storm rain flux Storm volume Storm area	None	None	+76%, < 0.05 +43%, < 0.05 +43%, < 0.05
Cuba Experiments 1985	Single Cld & Cloud Cluster Heights and Rain Volumes	None	None	Suggested Hgt and Rainfall Increases for Clouds 6-8 km Tall at Treatment
Cuba Experiments, 1986-1990	Cloud Echo Hgts (All Sample)	None	+4%, 0.77	None
Cuba Experiments, 1986-1990	Cloud Rainfall (All Sample)	None	+47%, 0.22	None
Cuba Experiments, 1986-1990	Cloud Echo Hgts (Tops 6.5 to 8 km at seeding)	None	+8%, 0.49	None
Cuba Experiments, 1986-1990	Cloud Rainfall (Tops 6.5 to 8 km at seeding)	None	122%, 0.07	None
Cuba Experiments, 1986-1990	Cloud Cluster Echo Heights	None	+4%, 0.06	None
Cuba Experiments, 1986-1990	Cloud Cluster Rainfall	None	+43%, 0.04	None
Cuba Experiments, 1986-1990	Cloud Cluster Echo Heights (Tops 6.5 to 8 km at seeding)	None	+17%, 0.01	None
Cuba Experiments, 1986-1990	Cloud Cluster Rainfall (Tops 6.5 to 8 km at seeding)	None	+65%, 0.02	None
Thailand, 1994-1998	Cell Echo Height	+5%, 0.21*	None	None
Thailand, 1994-1998	Cell Rainfall	+35%, 0.11*	None	None
Thailand, 1994-1998	Target Rainfall	+91%, 0.08*	None	None
Thailand, 1991-1998 (intermittent)	Cell Echo Height	None	None	+3%, 0.25
Thailand, 1991-1998 (intermittent)	Cell Rainfall	None	None	+37%, 0.07
Thailand, 1991-1998 (intermittent)	Target Rainfall	None	None	+92%, 0.03
Thailand, 1991-1998 (intermittent)	Target Rainfall (multiple regression)	None	None	+43% to +73%, 0.14 to 0.06

There were 104 days of experimentation, 53 seed and 51 no seed. Of these, 29 (14 seed and 15 no seed) are so-called A days and 75 (39 seed and 36 no seed) are so-called B days. B days are days on which the clouds received 60 flares or more and, according to Woodley et al. (1982), comprise the data set to which the FACE conceptual model best applies. A days are days on which clouds received less than 60 flares because the flight scientist decided that the target suitability criteria were no longer satisfied. A re-randomization analysis of the B days yielded

S/NS ratios of 1.49 with a one-sided P-value of 0.01 and 1.23 with a one-sided P-value of 0.08 for the FT and TT, respectively. For the combined A and B days, the re-randomization analysis yielded S/NS ratios of 1.46 with a one-sided P-value of 0.03 and 1.29 with a one-sided P-value of 0.05 for the FT and TT, respectively. A linear model analysis of the data was carried out in an attempt to take into account some of the natural rainfall variability and this resulted in somewhat larger point estimates of the seeding effect with somewhat stronger P-value support than did the re-randomization analyses.

The next step was an attempt to confirm the results of FACE-1. FACE-2 was carried out during the summers of 1978, 1979 and 1980 (Woodley et al., 1983). Whereas FACE-1 was an exploratory experiment, FACE-2 was designed and conducted as a confirmatory experiment. It attempted to confirm the principal seeding effects observed in FACE-1 in accordance with clarified and sharpened confirmatory specifications provided by Woodley et al. (1982), and to replicate the main analyses of FACE-1. Three levels of confirmation, ordered from weakest to strongest, were specified. Failure to confirm at one level precluded moving on to the next strongest level of confirmation.

FACE-2 failed to confirm the findings of FACE-1 at the first and weakest level of confirmation. FACE-2 also failed to replicate the main analyses of FACE-1. The FACE-2 re-randomization analysis of the B days yielded S/NS ratios of 1.08 with a one-sided P-value of 0.42 and 1.04 with a one-sided P-value of 0.45 for the FT and TT, respectively. The re-randomization analysis of the combined A and B days yielded S/NS ratios of 1.21 with a one-sided P-value of 0.30 and 1.03 with a one-sided P-value of 0.45 for the FT and TT, respectively. The linear model analysis of the data by Flueck et al. (1986) yielded equally disappointing results with apparent seeding effects on the total target of 10 to 15%. The reason for the different results in the two Florida experiments is unknown.

One is left with perhaps three alternatives in interpreting the FACE-2 result: 1) cloud seeding as practiced in Florida does not work or 2) the sample size at experiment termination was too small and the seeding effect was masked by the natural rainfall variability, or 3) the seeding flares failed to perform as expected. If one accepts the first interpretation, he must be able to explain the results of FACE-1 and the results in Texas, Thailand and Cuba (see Table 2) to be discussed next. If seeding does not work, it ought not to work anywhere under similar conditions. The second interpretation is always a possibility, although the linear model analysis should have accounted for some of this variability. The third interpretation is a possibility since the seeding flares produced by Nuclei Engineering, Inc. were having serious ignition problems during the program as verified by night tests of the flares. Some were seen to eject from the aircraft but failed to ignite. Others ignited after ejection but extinguished a few seconds later. Still others ejected and burned as designed. At one point a night flare test indicated that the problem had been corrected, but that may not have been the case, since the performance of the flares was known to vary from batch-to-batch. Regardless, the program proceeded with the conviction, based on the last night flare test, that the flare problem had been corrected and flare failure has never been mentioned formally as a possible explanation for the results of FACE-2. The offering of such an excuse after-the-fact would have been greeted as a "lame" attempt to explain away the "failure" of FACE-2.

By the late 1980's the randomized area experimentation had been moved to Texas where experiments on clustered clouds within a floating experimental unit covering 1,964 km² were conducted on an intermittent basis through 1994. The design of the Texas experiments was based on the findings of Matthews (1983) that most of the rainfall in Texas is produced by clustered rather than isolated convective clouds. One seeder aircraft worked this area, which was nearly seven times smaller than the fixed FACE target. The experiments were terminated after the 1994 season due to a lack of funds. At program termination 38 randomized cases had been obtained. The average radar-estimated seed rainfall exceeded the average radar-estimated non-seed rainfall by 45% by 2.5 h after unit qualification. This result is not statistically significant (P value = 0.16, Woodley and Rosenfeld, 1996).

Analyses of the effect of seeding on the treated convective cells were conducted within the context of both the Florida and Texas area experiments. All treated convective cells within a particular experimental unit had the same treatment decision, because the randomization was done on a unit basis. Because of this lack of independence, the cells in a particular unit had to be viewed as a single data point, obtained by averaging the cell properties, for the purposes of statistical testing. Each data point was weighted according to the number of cells contributing to its average in relation to the overall cell sample. Further, the cells in a particular unit were not independent physically of one another. Thus, a cell seeded an hour after seeding commenced in the unit probably was affected in some way by the earlier treated cells. This complicates the interpretation of the cell results.

The initial impetus for these cell analyses was the second Florida Area Cumulus Experiment (FACE-2), which failed to confirm the results of the first experiment (FACE-1; Woodley et al., 1983). The obvious question at this point was whether an effect of treatment was evident in the cells, which received the actual AgI treatment. Gagin et al., (1986) did this analysis, finding radar-estimated seeded height and rainfall increases of 22% and 160%, respectively, for cells treated early in their lifetimes with ≥ 9 50-g AgI flares with exploratory, one-tailed P-values of 2% and $< 1\%$, respectively. There was no evidence of effects for the entire cell sample, suggesting the overall seeding effect was indeed weaker in the FACE-2 experiment.

The finding that an effect of seeding on the cell scale in FACE-2 was noted only when more than 9 flares were expended tends to support the unverifiable hypothesis discussed above concerning the flares. If the flares were indeed having ignition problems, only with the expenditure of a large number of flares could one be confident that at least some of them burned in the clouds.

Comparable cell analyses were completed in the context of the Texas area experiments with the finding for the overall sample that the radar-estimated seeded cell heights were 10% taller and produced 163% (i.e., $SR = S/NS = 2.63$) more rainfall than the non-seeded cells at P-values of 21% and 1%, respectively. The apparent seeding effects are larger for clouds having base temperatures $> 16^{\circ}\text{C}$ in which coalescence is active, suggesting clouds with coalescence are more responsive than the overall sample (Woodley and Rosenfeld, 1996).

These results satisfied the requirement that seeding effects must be evident first on the cell scale before one can hope to see seeding effects on an area basis. Considering it is the cells,

which receive the treatment, this has seemed a reasonable requirement. How treated cells might communicate any effects to groups of cells and to the unit overall is addressed in the conceptual model.

Simultaneous with the early years of the Texas experimentation was a series of randomized glaciogenic cloud seeding (dry ice) experiments near Nelspruit, South Africa during the 1984/1985 to 1986/1987 seasons (Mather et al., 1996). The experiments involved the on-top seeding of new cloud turrets growing on the flanks of isolated multicellular storms using dry ice delivered from a Learjet near the height of the -10°C isotherm. All 94 storms meeting the selection criteria were tracked by radar operating in computer-controlled volume-scan mode. Because cloud physics measurements indicated that the effect of seeding would be greatest in clouds having coalescence and raindrops, the main screening criterion involved the ratio of cloud-base temperature (T_{CCL}) to the potential buoyancy (PB) at 500 mb. Clouds growing on days when $T_{\text{CCL}}/\text{PB} > 2.0$ constituted the main data partition in which coalescence and positive seeding effects were expected.

The seeding rate in the South African experiments was 1.3 g of dry ice per meter of flight path, giving 3.9×10^3 g for a cloud tower having a diameter of 3 km. Since the effectiveness of dry ice has been estimated to be between 10^{12} to 10^{13} ice crystals per gram of dry ice (Cooper et al., 1982), this hypothetical cloud would have received between of 3.9×10^{15} and 3.9×10^{16} ice crystals. Current AgI seeding flares produce about 10^{14} ice nuclei per gram of formulation at -10°C . The expenditure of five 20-g flares on a cloud pass would produce about 10^{16} ice nuclei in the cloud at -10°C . Assuming that each ice nucleus produces an ice crystal, the number of ice crystals produced during a typical AgI seeding run is comparable to that produced by dry ice seeding in the randomized South African experiments.

The results are summarized in Table 2. Within the coalescence partition, radar detected a statistically significant increase in the height of the center of the rain mass in the seeded clouds relative to the unseeded storms in the 10-min period after storm selection. This increase persisted into the 10-20-min period. In the 20-30 min period, however, the seeded storms showed a statistically significant decrease of storm mass with height. Simultaneous with this was the appearance of the first increases in rainfall at cloud base, which were apparently caused by an increase in rain rate rather than an increase in storm area. In the 30-40 min period the seeded clouds had 76% more rain flux, 43% more storm volume and 43% more storm area than the unseeded clouds. All results, which are likely the result of static and dynamic effects, have P values $\leq 5\%$.

The recent Thai results are especially relevant to the Texas effort. These randomized, cold-cloud, rain enhancement experiments were carried out during 1991-1998 in the Bhumibol catchment area in northwestern Thailand. These experiments involved exploratory experimentation in 1991 and 1993, which suggested increases in rainfall due to seeding. This was followed by a "demonstration" experiment to determine the potential of on-top AgI seeding for the enhancement of areal (over $1,964 \text{ km}^2$) rainfall. It was conducted in accordance with a moving-target design. The treatment units were vigorous supercooled clouds forming within the experimental unit, having a radius of 25 km and centered at the location of the convective cloud that qualified the unit for initial treatment. The unit drifted with the wind as the S-band project

radar collected 5-min volume-scan data to be used for the evaluation of cell and unit properties. The criteria for unit qualification and termination and the experimental procedures, involving the ejection of 20-g AgI flares near cloud top, are addressed in the design and summarized herein.

Evaluation of the demonstration experiment until its scheduled termination in 1998, consisting of 62 experimental units (31 S and 31 NS), gave a S ($11,519 \times 10^3 \text{ m}^3$) to NS ($6,021 \times 10^3 \text{ m}^3$) ratio of mean rain volumes over the unit lifetimes of 1.91 at a statistical P value of 0.075. The ratio of S ($5,333 \times 10^3 \text{ m}^3$) to NS ($3,516 \times 10^3 \text{ m}^3$) median rainfalls is 1.52. Evaluation of the units at 300 minutes after their qualification, which has historical precedent, gave a S ($7,930 \times 10^3 \text{ m}^3$) to NS ($5,348 \times 10^3 \text{ m}^3$) ratio of mean unit rainfalls of 1.48 at a P value of 0.123. Thus, the demonstration experiment fell short of statistical significance at a P value of 0.05, regardless of the period of evaluation.

Although the Thai "demonstration" experiment did not reach significance in the time allotted to it, there is much to be gained by exploratory examination of the entire data set (43 S and 42 NS). Beginning on the scale of the individual treated cells, it was found that the ratio of S to NS rain volumes is 1.37 at a P-value of 0.066. The other cell parameters have P-values < 0.05 except for the echo height. These results suggest that seeding increases the rain volume from individual cells by increasing their maximum radar reflectivities, inferred maximum rainfall rates, maximum areas, maximum rain-volume rates, duration, and their clustering and merger with other cells. These results are similar to comparable exploratory cell analyses in Texas.

The mean rain volumes for the unit durations are $10,398.78 \times 10^3 \text{ m}^3$ for the S sample and $5,404.19 \times 10^3 \text{ m}^3$ for the NS sample, giving a S/NS ratio of 1.92. This result is dominated by six huge S units, whose rain volumes exceed the largest value in the NS sample. Deletion of the wettest S ($105,504 \times 10^3 \text{ m}^3$) and wettest NS ($17,709 \times 10^3 \text{ m}^3$) units as a sensitivity test gave a revised S ($8,134 \times 10^3 \text{ m}^3$) to NS ($5,104 \times 10^3 \text{ m}^3$) ratio of rain volumes of 1.59 at a P value of 0.040. Normalization of the entire sample to the overall NS mean unit rainfall to account for year effects decreased the apparent effect slightly (1.88) but improved the P value slightly to 0.009.

Linear regression analyses to account for the natural rainfall variability in the experiment suggest a smaller apparent effect of seeding. The ratio of S to NS unit rainfalls after accounting for as much as 29% of the natural rainfall variability ranges between 1.43 and 1.73 at P values of 0.136 and 0.063, respectively. Although the poor correlations between the individual covariate candidates and the unit rainfalls (all < 0.45) suggest that the value of these estimates is problematic, it is still likely that the factor of 1.92 for the seeding effect in Thailand is an overestimate of the real effect, if such could be known.

A major uncertainty in the Thai experiments is whether and how the apparent effects of seeding were propagated in space and time, considering that seeding had ended typically by two hours after unit qualification. Upon tracking echoes that had treated ancestry, it was determined that 43% of the S and 53% of the NS rain production in the units came from echoes having such ancestry. The balance was produced by cells without this direct physical connection. In the case of the S sample, cells with treated ancestry could be tracked to nearly 480 minutes after unit qualification, although their rain production by that time was small relative to the unit total. It was found also that the apparent effects of seeding were propagated beyond the unit boundaries.

It is hypothesized, in accordance with the predictions of Simpson (1980), that downdrafts, beginning on the cell scale and propagating through the unit, are the primary mechanism for the propagation of seeding effects in space and time. Analyses of the treated cells, indicating increased rainfall and increased cell clustering and merger, are consistent with this expectation. Secondary seeding, whereby unseeded clouds ingest ice nuclei and ice particles from previously seeded clouds, also has been hypothesized as a likely contributor to the apparent effect of seeding. The direct evidence supporting either hypothesis is presently weak and circumstantial.

The results of experimentation in Cuba, which was conducted concurrent with the Thai cold-cloud experiment, are also quite supportive. These randomized seeding experiments on tropical convective clouds were conducted in the Camaguey area of Cuba from 1985 to 1990 (Koloskov et al., 1996). The purpose of the experiment was to assess the capability of cold-cloud seeding with silver iodide pyrotechnics to augment radar-estimated rainfall from individual convective clouds and convective cell clusters over Cuba.

The Cuba experiment was carried out in two steps. An exploratory experiment was carried out in 1985 in order to determine the type of convective clouds that responded best to seeding. A total of 46 convective clouds, 29 seeded and 17 unseeded, were studied. An analysis of these data indicated that clouds thought to be most suitable for seeding were optically dense growing clouds whose tops had risen to at least the height of 6 - 8 km (cloud top temperatures between -10° and -20°C) and have cloud top diameters between 2 and 5 km. Seeded clouds meeting these criteria appeared to grow taller, live longer and produce more radar-estimated rainfall than their unseeded counterparts.

A confirmatory phase of the experiment was carried out during 1986-1990 on both individual convective clouds and convective cell clusters. A total of 46 individual convective clouds, 24 seeded and 22 unseeded, and a total of 82 convective cell clusters, 42 seeded and 40 unseeded, were obtained. The analysis focused on the effects of seeding on the radar-estimated properties of both the individual convective clouds and cloud clusters including rain volume, maximum echo height, maximum radar reflectivity, maximum echo area, total echo area and duration. A cell short-tracking methodology similar to that of Rosenfeld (1987) was developed to derive the radar-estimated cloud properties. Using the Mann-Whitney 2-sample test, the analysis of the individual convective clouds indicated that the S/NS ratio for radar-estimated rain volume was 1.47 with a P-value of 0.22 and the S/NS ratio for maximum echo height was 1.04 with a P-value of 0.77.

For the subset of the individual convective clouds with tops between 6.5-8.0 km, the S/NS ratio for radar-estimated rain volume was 2.22 with a P-value of 0.07 and the S/NS ratio for maximum echo height was 1.08 with a P-value of 0.49. The analysis of convective cell clusters indicated that the S/NS ratio for radar-estimated rain volume was 1.43 with a P-value of 0.04 and the S/NS ratio for maximum echo height was 1.04 with a P-value of 0.06. For the subset of convective cell clusters with tops between 6.5-8.0 km, the S/NS ratio for radar-estimated rain volume was 1.65 with a P-value of 0.02 and the S/NS ratio for maximum echo height was 1.17 with a P-value of 0.01.

Taken collectively, the results of relevance to Texas over the years would appear to suggest that seeding with an ice nucleant may be useful for enhancing area rainfall. Proof from a single experiment that is the case is still lacking. Despite these uncertainties, operational cloud seeding to increase precipitation has been conducted intermittently over the past 40 years at various locations around the world. The current program in Texas, which now involves ten project sites, is only the latest in a long line of such programs.

6.0 AREAS OF DISAGREEMENT AND UNCERTAINTY

There is considerable dissent concerning the efficacy of seeding with an ice nucleant (i.e., glaciogenic seeding) for the enhancement of rainfall. The underlying theme of some current criticism is that not much worthwhile has been accomplished with glaciogenic seeding in the past 40 years and that research money would be better spent in investigations of the effects of hygroscopic seeding. The results of a hygroscopic Thai experiment (Silverman and Sukarnjanaset, 2000) and the results of an experiment in South Africa (Mather et al., 1997) and preliminary results of a follow-up experiment in Mexico (Bruitjes, 1999) for the seeding of individual clouds with hygroscopic flares are highly encouraging, but they are no better than the results obtained for the seeding of individual clouds using an ice nucleant.

Their criticism of cold-cloud seeding has been summarized as follows:

“Based on a rigorous examination of the accumulated results of the numerous experimental tests of the static-mode and dynamic-mode seeding concepts conducted over the past 4 decades, it has been found that they have not yet provided either the statistical or physical evidence required to establish their scientific validity. Exploratory, post-hoc analyses of some experiments have suggested possible positive effects of seeding under restricted meteorological conditions, at extended times after seeding and, in general, for reasons not contemplated in the guiding conceptual seeding models; however, these exploratory results have never been confirmed through subsequent experimentation.

If glaciogenic seeding of convective clouds for rain enhancement is to be pursued further, well-defined physical-statistical tests of the static-mode and dynamic-mode seeding concepts, in accordance with the proof-of-concept criteria, are needed to determine if they are, in fact, scientifically valid. People with water interests at stake who are investing in operational glaciogenic cloud seeding projects for precipitation enhancement should be aware of the inherent risks of applying an unproven cloud seeding technology and provide a means for evaluation in order to assess the scientific integrity and effectiveness of the operational seeding projects (Silverman, 2001).”

Some of the pessimism expressed in the statement above is due to challenges to two apparently successful “static mode” seeding experiments. The most venerable is the series of Israeli experiments. Some scientists have become disillusioned by these challenges.

6.1 Uncertainty over the Israeli Experiments

The Israel-1 cloud seeding experiment (Gagin and Neumann, 1974) was conducted during the period 1961-1967. It was designed as a randomized crossover experiment with North and Center target areas separated by a buffer zone. Each day was randomly allocated for seeding in either the North or Center target area with the non-seeded area acting as control for the seeded area. Seeding was accomplished by dispersing silver iodide smoke from an airplane at cloud-base level, parallel to the coastline upwind of the randomly selected target area. The Root-Double-Ratio (RDR) was designated as the test statistic in evaluating the experiment (Gabriel, 1999b). The evaluation yielded an RDR of 1.15, i.e., a rain enhancement of 15%, with a one-sided P-value of 0.009 for the combined targets. It was found through exploratory analysis that the rain increase peaked in the interior part of the targets located 25-50 km downwind of the seeding line, yielding a suggested rain increase of 22% for the combined targets with a one-sided P-value of 0.002. Exploratory analyses of the North and Center targets separately were also conducted (Neumann and Shimbursky, 1972; Gagin and Neumann, 1974). The single area ratio (SAR) for the North and Center target areas were 1.15 and 1.16, respectively, with associated P-values of about 0.16 for both target areas.

The Israel-2 cloud seeding experiment (Gagin and Neumann, 1981) was conducted during the period 1969-1975 as a randomized crossover experiment with North and South target areas separated by a buffer zone. The Center target in Israel-1 was extended far to the south to form the South target for Israel-2, nearly doubling its area. As in the Israel-1 experiment, each day was randomly allocated for seeding in either the North or South target area with the non-seeded area acting as control for the seeded area.

Gagin and Neumann (1981) stated that the Israel-1 experiment was based on several working hypotheses and its exploratory results formed the basis of the "confirmatory" Israel-2 experiment. They reported that the primary purpose of Israel-2 was to enhance rainfall through seeding in the Lake Kinneret catchment area that serves as the principal reservoir of the Israel National Water Carrier. Therefore, the seeding line for the North target was shifted inland in an attempt to focus the maximum seeding effect on the catchment area. This created an upwind control area for the North target allowing a target-control evaluation of seeding effects on the North target alone. The seeding line for the South target was on the coastline as before. A network of ground generators was installed in the North and South target areas to supplement the aircraft seeding.

Using the double ratio (DR) statistic (Gabriel, 1999b), Gagin and Neumann (1981) indicated that the rainfall in the North target area was increased by 13% with a P-value of 0.028. The largest seeding effect was found over the catchment area of Lake Kinneret where the suggested rainfall increase was 18% with a P-value of 0.017.

A third randomized experiment (Israel-3) was launched in 1975 that was designed to evaluate the seeding effect on the South alone. The South target area of Israel-2 became the primary target of Israel-3, excluding its southwest corner that was designated as an upwind control area to facilitate this evaluation. An intermediate analysis was done for 682 experimental days in the period November 1976 to April 1991 (Nirel and Rosenfeld, 1994). Based on a

Double Ratio (DR) statistic, a 4.5% decrease in rainfall with a two-sided P-value of 0.42 was indicated; there was no statistical support for a change in rainfall in the South target area.

The Israeli experiments were what is called "black-box" experiments, that is the clouds were seeded with the silver iodide particles and the primary variable measured and analyzed was the precipitation on the ground (Cotton, 1986). The Israeli experiments were based on a general conceptual model that evolved from previous physical studies of clouds and cloud systems in the experimental area, and the experimental results were analyzed for their physical plausibility within stratifications of the experimental data. Gagin (1986) acknowledged that the Israeli approach was risky because of the complexity in making sound physical hypotheses on the basis of circumstantial scientific evidence only; however, he justified its use on the grounds that it required less human and equipment resources, and had the potential of providing quicker answers at a reduced cost under favorable conditions.

According to Gagin (1981) physical plausibility of the results of the Israeli experiments rests on statistical analyses of the rainfall data that confirm the microphysical predictions based on the general conceptual model that evolved from previous field studies. Previous field studies indicated that continental clouds over Israel exhibit high colloidal stability as indicated by the narrowness of the cloud droplet spectra and the apparent inefficiency of the collision-coalescence mechanism at the droplet sizes observed. From these observations, Gagin and Neumann (1974) concluded that ice crystals are essential for the formation of precipitation in these clouds and this, coupled with the absence of ice crystal multiplication mechanisms, formed the basis for cloud seeding with glaciogenic seeding agents in Israel.

Gagin (1981) stated that the most physically significant result of the Israeli experiments was the statistically stratified analyses of the data according to cloud top temperature. The largest seeding effect with the smallest P-value was found in the cloud-top temperature stratification of -15 to -21°C, the temperatures at which seeding should be most effective according to the general conceptual model. For both warmer and colder cloud-top temperature stratifications the magnitudes of the seeding effect decreased and their P-values increased. As additional physical evidence Gagin (1981) stated that known patterns of turbulent diffusion of the seeding material released at cloud base altitudes was sufficient to explain the finding that maximum seeding effect was consistently found 30-50 km downwind of the seeding line. He concluded that these studies, while far from being complete, provide a fair basis for understanding and accepting the statistical results and thus also indicate which criteria should be used to transfer the static-mode seeding technique to other geographical areas.

Gabriel and Rosenfeld (1990) reanalyzed Israel-2 as a randomized crossover (North vs South) experiment, asserting that the experiment was designed and conducted with this in mind. Indeed, Gagin and Neumann (1974) analyzed the first 2 years of Israel-2 as a randomized crossover experiment. Gabriel and Rosenfeld (1990) used the RDR as the test statistic, as was done for Israel-1, and obtained a 2% decrease in rainfall with a two-sided P-value of 0.64; there was no apparent effect on the rainfall in the combined targets. Applying the crossover RDR analysis to the Lake Kinneret catchment area in the North (which was targeted for maximum effect) and the central area in the South, a 2% decrease in rain with a two-sided P-value of 0.67 was obtained. In an effort to discover if there was a suggestion of seeding effects on the

individual targets, especially in light of the results of Israel-1, they conducted a series of exploratory analyses. In particular, they examined the evidence with regard to 3 possible alternative hypotheses: (1) N_0S_0 , seeding had no effect on either the North or South target, (2) $N+S_0$, there was a positive effect of seeding in the North and no effect in the South, and (3) $N+S$, there was a positive effect of seeding in the North and a negative effect of seeding in the South. While there was some evidence in support of all 3 hypotheses, they concluded that the weight of the evidence, while not conclusive, tended to favor the third hypothesis, $N+S$. The single ratio evaluation of the North and South targets separately indicated a 15% increase in rain with a two-sided P-value of 0.23 and a 17% decrease in rain with a two-sided P-value of 0.15, respectively. The single ratio evaluation of the catchment and south central areas separately yielded similar results.

Rosenfeld and Farbstein (1992) sought to explain the ineffectiveness of seeding in the South by proposing a desert-dust hypothesis. They postulated that desert dust, advected from the north African, Sinai and Negev deserts, acting as ice nuclei and/or giant CCN (sulfate-coated desert dust as shown by Levin et al., 1996), seeded the clouds in the South, thereby negating the effect of the silver iodide seeding particles. Studies by Levi and Rosenfeld (1996) and Rosenfeld and Nirel (1996) provide some support for the desert-dust hypothesis. On the other hand, Levin et al. (1997) suggested that seeding was less effective in the South because the effective concentration of silver iodide particles at activation temperatures was much lower than it was in the North. Using a 3-dimensional meso-scale model, they simulated the seeding operation in the Israel experiments and the resulting dispersal of the seeding particles. They found that high concentrations of seeding particles were removed from the atmosphere by downdrafts below the clouds in the South, resulting in seeding particle concentrations at activation temperatures that were about one-third that obtained in the North.

Rangno and Hobbs (1995) challenged both the statistical results of the Israel-1 and Israel-2 experiments, and the appropriateness of the static-mode seeding concept upon which these experiments were based. An examination of the distribution of rainfall in the target areas and buffer zones as well as the areas surrounding them led them to suggest that the results of both Israel-1 and Israel-2 were compromised by a type-I statistical error (that is false positives or "lucky draws"); however, they (Rangno and Hobbs, 1997) did admit that the chances of lucky draws occurring in both experiments were very slim. Citing the results of analyses of the precipitation climatology of Israel and measurements of the microstructure of Israeli clouds by Levin (1992), Rangno and Hobbs (1995, 1997) showed that convective clouds in Israel produce large cloud droplets, precipitation-sized drops, high concentrations of ice crystals, and precipitation at relatively warm cloud-top temperatures, all of which are not consistent with the physical criteria for applying the static-mode seeding concept. Without any concomitant cloud physics measurements taken during the Israeli experiments, it is not possible to determine what fraction of the clouds that were treated was actually conducive for rainfall enhancement by the static-mode seeding concept.

6.2 Uncertainty over the Climax Experiments

As mentioned in section 5.1, the Climax experiments were accepted widely as successful orographic cloud seeding experiments. Climax I (1960-1965) and Climax II (1965-1970), were carried out in the Colorado Rockies near the town of Climax. Areas near the Continental Divide were seeded by silver iodide generators, which were operated high on the western slopes of the Rocky Mountains. One of the most important results of Climax I was the finding that snowfall was increased when the ambient 500 mb temperature was warmer than -25°C and decreased at colder temperatures (Mielke et al., 1970). For the similar follow up project called Climax II, Mielke et al. (1971) presented results that essentially confirmed the findings for Climax I. However, reanalyses of the Climax data reported by Rangno and Hobbs (1987; 1993) cast doubt on the original findings regarding the effectiveness of the cloud seeding.

Rangno and Hobbs (1993) made the following points: 1) Cloud seeding had no effect on precipitation in Climax I after the control stations had been chosen halfway through the experiment. 2) Faulty execution of the randomization scheme resulted in a misleading precipitation climatology and a misleading relationship between cloud-top and 500-mb temperatures for the control days. 3) The method of assigning upper-level winds and temperatures to experimental days emphasized widespread, synoptic-scale weather systems with cloud tops far above 500 mb rather than the orographic "blanket" clouds that were sought. 4) Particle trajectory calculations show that it is unlikely that the silver iodide released from the ground could have affected precipitation at Climax in southwest flow, the category for which the greatest seeding effect was reported. These matters have not been resolved.

6.3 Uncertainty over warm-season cloud seeding experiments

Silverman (2001) is critical also of dynamic-model seeding experiments. The concluding section of his assessment states the following:

"According to the proof-of-concept criteria, numerous investigations of the dynamic-mode seeding concept over the past 35 years have failed to provide either the statistical or physical evidence required to establish its credibility. None of the experiments resulted in a statistically significant increase in rainfall in accordance with its *a priori* design. The first version of the dynamic cold-cloud conceptual model postulated a seeding-induced increase in maximum cloud-top or echo-top height and, indeed, it appeared to occur in the Caribbean and South Florida experiments. The results of the Texas experiment prompted a significant revision to the dynamic cold-cloud seeding conceptual model whereby a seeding-induced increase in the invigoration of the updraft, but not necessarily an increase in the maximum cloud-top or echo-top height, was postulated; however, the postulated invigoration of the updraft has never been verified. Each of the dynamic-mode seeding experiments was based on a stated seeding conceptual model with explicit hypotheses, the testing of which resulted in evaluations based on the *a priori* design that failed to reach statistical significance and numerous exploratory analyses that purported to show positive seeding effects. In the opinion of this reviewer, the reports of the results of these experiments placed greater (exaggerated) emphasis and meaning on the suggestive-but-iffy rainfall results of the exploratory analyses, which have never been

confirmed or replicated in subsequent experiments, than on the disappointing-but-valid evaluations in accordance with their *a priori* designs.”

Woodley and Rosenfeld (2001) commented on the Silverman (BAS) assessment, but it had not been published as of November 2001. Excerpts from the concluding section of their Commentary are provided below:

“In our view the BAS assessment of the status of glaciogenic cloud seeding experimentation is unduly pessimistic. Although we agree that dynamic-mode seeding has not yet been proven scientifically, we contend that the collective weight of the evidence gives scientific credibility to dynamic-mode seeding, based on the criteria set forth at the outset. Virtually every entry in his Table 2, providing a summary of the main statistical results of the various dynamic-mode seeding experimentation discussed in his article has a SR (ratio of Seed to Non-Seed measurement) value > 1 with varying levels of P-value support. The probability of this happening by chance is minuscule. Quantification of the apparent seeding effect, requiring the proper form of meta-analysis, is much more difficult. It should be cautioned that the results of such an analysis would pertain to dynamic cloud seeding as a whole and would not necessarily provide statistical evidence for the efficacy of cloud seeding in any particular experiment.

“Likewise, we think BAS is overly critical of the physical evidence accumulated to date in support of dynamic-mode seeding experiments. Although direct physical measurements were not made in the experimental units, a major effort has been made over the years to make measurements of relevance to the “dynamic” seeding experiments. Several of the studies involved the randomized seeding of the physical experimental units. Collectively, these measurements support the conceptual model as articulated by Rosenfeld and Woodley (1993). As such, they provide a measure of scientific credibility for the physical aspects of dynamic-mode seeding.”

All versions of the conceptual models guiding on-top glaciogenic seeding experiments also have called for increased vertical growth of the seeded clouds. Statistically significant increases in cloud growth averaging about 20% have been documented for clouds over the Caribbean and Florida (Simpson et al., 1967; Simpson and Woodley, 1971). Clouds seeded in Texas (Woodley and Rosenfeld, 1996) and Thailand, however, have shown much less vertical growth with weak P-value support (see Table 2). These apparently contradictory results have been criticized also by Silverman (2001). Fortunately, there appears to be a plausible physical explanation for the contradictory results.

During the Caribbean and Florida single cloud experimentation the visible cloud tops were measured by flying a B-57 jet aircraft just above the cloud top, even if the cloud were a tall cumulonimbus. In the Texas and Thai experimentation, however, the estimates of cloud top were made using 5-cm and 10-cm radar, respectively, at a reflectivity threshold of 12 dBZ. Thus, the visible cloud tops were measured in the Caribbean and Florida and the echo tops at 12 dBZ were measured in Texas and Thailand. Because echo tops are less than the visible cloud in the absence of sidelobe errors, the actual heights of cloud tops in Texas and Thailand have been underestimated relative to clouds over the Caribbean and Florida.

This would not be a problem for the estimate of the effect of seeding on cloud growth, however, as long as the radar “sees” seeded and non-seeded clouds the same way. However, this is not likely the case. Seeding changes the microphysical structure of the clouds, causing glaciation at higher temperatures (Sudikoses et al., 1998). As such, they resemble natural more maritime clouds (Rosenfeld and Lensky, 1998), which are characterized by early glaciation and fallout of precipitation-sized particles. The reflectivity of these clouds falls off faster with height above the 0°C-isotherm level than more continental clouds (Zipser and Lutz, 1994). Thus, if seeded clouds are made to resemble glaciated natural maritime clouds, it follows the radar is going to underestimate their tops at 12 dBZ more than non-seeded clouds, which do not glaciate until colder temperatures. The seeded clouds may be taller physically than the non-seeded clouds but that cannot be known through the radar measurements. The measurement of cloud tops using aircraft and/or infrared satellite imagery is necessary to resolve this important uncertainty.

6.4 Stringent Criteria for Assessing the Success of Cloud Seeding Experiments

In order to understand the major points of the criticisms, it is necessary to take a closer look at the 1998 AMS Policy Statement on Planned and Inadvertent Weather Modification (AMS, 1998). The relevant portion of that document is quoted (in *italics*) here:

“Because the expected effect of cloud seeding is within natural meteorological variability, statistical as well as physical evidence is required to establish the success of any cloud seeding activity. Statistical evidence is most efficiently obtained through a randomized, statistical experiment based on the seeding conceptual model that is conducted and evaluated in accordance with its a priori design, and results in the rejection of the null hypothesis (hypotheses) at an appropriate level of significance and power of detection. The physical plausibility that the effects of seeding suggested by the results of the statistical experiment could have been caused by the seeding intervention i.e., the physical evidence is consistent with the statistical evidence, must then be established through measurements of key links in the chain of physical events associated with the seeding conceptual model. Physical evidence is essential in confirming the validity of the seeding conceptual model, which provides the basis for transferring the cloud seeding methodology to other geographical areas.”

To assess whether any glaciogenic seeding experiments have satisfied this policy statement, stringent “proof-of-concept” criteria have been developed, which emphasize the results of randomized statistical experiments conducted and evaluated in accordance with their *a priori* design as the most credible evidence of seeding effects (Gabriel, 1999a). In his application of these “proof-of-concept criteria” Silverman (2001) notes that “when the *a priori* design specifies or implies more than one hypothesis for testing, the statistical level of significance (usually 5%) will be shared equally among the number of hypotheses indicated whether the reported results do so or not.” He emphasizes further that failure to reject any null hypothesis does not connote that seeding is ineffective; rather, it simply means that the evidence was insufficient to establish that seeding worked as hypothesized. Conversely, he states that a statistically insignificant result with a test statistic (e.g., S/NS, seed/no-seed ratio) greater than unity is not and should not be interpreted as a positive effect of seeding any more than a S/NS ratio less than unity is not and should not be interpreted as a negative effect of seeding.

Upon using these strict “proof-of-concept” criteria, it is found that no warm-season area seeding experiment in which the design and evaluation were specified in advance (i.e., *a priori*) has reached statistical significance. This applies to hygroscopic seeding experiments as well, since they have not yet been carried out on an area basis.

Although the strict “proof-of-concept” criteria as applied to “*a priori*” experiments do not provide proof that seeding increased the area rainfall, much can be learned about the effects of seeding through exploratory analyses of the entire data sets. Virtually all past cloud seeding experiments have engaged in exploratory data analysis (see Table 2) and it is on the results of such analyses that operational cloud seeding programs are based. Most of the results quoted herein have been obtained from exploratory analyses. The reader is cautioned that P-values associated with exploratory analyses cannot be used to reject null hypotheses as is the case for analyses specified *a priori* (Gabriel, 1999a); however, they can be used as an indication of the strength of suggested effects, effects which can only be confirmed through new, *a priori* experiments specifically designed to establish their validity. How small a P-value has to be before an exploratory result is considered strong enough to be taken seriously (as “encouraging” or “promising”) is not generally defined but, in view of the problem of multiplicity of analyses, conventional wisdom dictates that it must be smaller than the P-value of 0.05 usually associated with the rejection of a null hypothesis in an *a priori* evaluation.

7.0 REASONS FOR THE UNCERTAINTY SURROUNDING CLOUD SEEDING EXPERIMENTS

Cloud seeding research is inherently an uncertain and controversial undertaking. There are many reasons for this situation. The biggest contributor to the uncertainty is the natural rainfall variability, which can confound the interpretation of the results. It can hide an effect of seeding in the natural rainfall noise or it can conspire to suggest an effect of seeding when in fact none is present. This is especially a problem for projects with small samples. The huge Thai seeded “blockbuster” day discussed in this report is a case in point. If this unit had not been seeded, our conclusions regarding the effect of seeding in Thailand might be different. On the other hand, one has to admit the possibility that seeding may have been partially responsible for the blockbuster nature of this event.

In the utopian world there are two ways to overcome natural rainfall variability. One is to obtain a huge sample such that the effect of seeding, assuming that one is present, is readily detected despite the background noise from the natural rainfall variability. The notion that “things will even out in the long run” is applicable here. The second way to overcome the natural rainfall variability is to use covariates to develop equations that predict the natural target rainfall. This was attempted with limited success in the analysis of the Thai cold-cloud experiment (see next section). If this were possible, departures from the predicted rainfall then could be attributed to the seeding intervention.

Another reason for the uncertainty surrounding cloud seeding experiments has been the lumping together of all seeding events in which the effects of seeding were mixed such that there appears to be no effect of seeding. As will be seen in the next section in a closer look at the results of the Thai experiment, the apparent effect of seeding depends on the cloud microstructure with

large apparent effects in one category and no apparent effect in another. It is crucial, therefore, to know how seeding affects the clouds so that the data can be partitioned into analysis categories and seeding effects can be sought within each category. If no effect is evident in the category thought most suitable for seeding, there will be legitimate reason for concern. Under such circumstances, all seeding should stop until the matter is resolved.

Sample size is an obvious contributor to the uncertainty surrounding cloud seeding experiments. Even if the seeding is working as intended, its effect will not be detected unless the experiment runs long enough to make the detection possible. There are statistical procedures to estimate the size of the needed sample, but the estimate is only as good as the estimate of the probable effect of seeding and the quantification of the natural rainfall variability. If the variability is large and the expected effect is small, the needed sample to establish the effect of seeding could be in the hundreds. Neither the Texas nor the Thai experiments, discussed earlier in this report, ran long enough to establish an effect of seeding. The exploratory Thai analyses suggest that another 40 units might have been adequate to establish an effect of seeding on an *a priori* basis. In the case of Texas, an additional 135 cases might have been necessary, if the 45% apparent seeding effect at project termination is the real effect. In both cases, the programs were terminated, not because the seeding was not working, but because of funding considerations. It is unfair, therefore, to characterize them as scientific failures when the problem lay not necessarily with the science but with project planning and administration.

Scientists have also added to the uncertainty by applying new criteria and new insights to old experiments, thereby forcing them to measure up to the modern age. The notion that statistical P-values should be shared among the various hypotheses being tested has caused old results to be re-evaluated downward, thereby diminishing their credibility among some modern scientists. Additionally, they discount physical measurements of relevance to the seeding experiment that have been made separately from the actual seeding experiment. They would require that the measurements be made during the actual randomized experimentation. The logic in this is obvious in that the observations are relevant immediately to the seeding experiment, but practical considerations, especially the availability of funds, often do not permit the needed observations to be made concurrent with the randomized experimentation.

The last and most obvious contributor to the uncertainty surrounding cloud seeding is that there are situations in which it does not produce the intended effect. Cloud seeding is an exceptionally complicated undertaking involving complex cloud and environmental processes that are poorly understood. Upon adding to this the difficulty of conducting the seeding as required to produce the effect, it is easy to understand why many seeding experiments are viewed as failures or at best inconclusive.

8.0 A CLOSER LOOK AT THE THAI EXPERIMENT AND ITS IMPLICATIONS FOR TEXAS

8.1 Overview

The Thai cold-cloud experiment is highly relevant to Texas for several reasons. First, the design and conduct of the randomized experiments in Texas and Thailand are very similar. In

fact, the design of the Thai experiment was copied from Texas. Second, the scientists who directed and evaluated both programs are Woodley and Rosenfeld. Third, after accounting for some of the natural rainfall variability in Thailand, the results for Thailand and Texas are similar. Fourth, the conduct of the seeding operations in both Texas and Thailand is similar to what is being done now in some of the operational cloud seeding programs of Texas. Although it is not a perfect match, the Thai experiment is the most relevant of any known experiment to what is being done in Texas.

Because of its relevance to Texas, it is important to take a closer look at the results of the Thai experiment, which are summarized in Table 3 for the experimental units. Moving from left to right in the table are the analysis type, the sample sizes, the mean S and NS unit rain volumes, the ratio of the former to the latter and the P-value significance of the result. The smaller the P value, the more significant is the result. It is emphasized that P-values for exploratory analyses do not have the same weight as P-values for *a priori* analyses. The former should be interpreted as providing the relative strength of the various analyses.

Table 3. Summary of the Thai RVOL (rain volume) Results for the Unit Lifetimes (RVOL in units of $10^3 m^3$)

Analysis	N _S , N _{NS}	RVOL(S)	RVOL(NS)	S/NS	P Value	Conf. Int.
All Units	43, 42	10,399	5,404	1.92	0.033	
Median Results	43,42	5,337	3,421	1.56		
Unit Durations	43,42	296.2 min	242.2 min	1.22	0.014	
All Units w/o wettest S and NS	42,41	8,134	5,104	1.59	0.040	
All Units SCR Index						
0%	11, 9	4,857	2,119	2.29 (1.70)	0.052	
0 to 9%	11, 10	5,206	2,239	2.32 (1.72)	0.029	
10 to 49%	8, 8	24,688	6,675	3.70 (2.74)	0.116	
50 to 89%	13, 15	7,806	4,925	1.59 (1.18)	0.171	
90 to 100%	11, 9	8,793	7,904	1.11 (0.82)	0.383	
100%	3, 5	9,054	7,708	1.17 (0.87)	0.379	
All Units with Nrmztn	43, 42	10,157	5,404	1.88	0.009	
All Units w/o & w/ Multiple Regression	43,42	10,399 obs 9,067 pred	5,404 obs 6,767 pred	1.92 All 1.34 Bias 1.43 Net	0.033 0.136	

N_S and N_{NS} = Seed and No Seed sample sizes.

Beginning with the first row, the mean rain volumes for the unit lifetimes are $10,399 \times 10^3 \text{ m}^3$ for the S sample and $5,404 \times 10^3 \text{ m}^3$ for the NS sample, giving a S/NS ratio of 1.92. This result has a rerandomization P-value of 0.033 (Table 3). This apparent effect is larger than was expected at the outset of the experiment, suggesting that the S days may have been more favored by the natural rainfall variability than the NS days. The ratio of S ($5,337 \times 10^3 \text{ m}^3$) to NS ($3,421 \times 10^3 \text{ m}^3$) median rainfalls is 1.56. The ratio of the S (296.2 minutes) to NS (242.2 minutes) unit lifetimes (time from unit qualification to the time echo disappears from the unit) is 1.22 at a P value of 0.014, suggesting that seeding prolongs the unit lifetimes.

The S exploratory sample consists of six huge units, whose rain volumes exceed the largest value in the NS sample. Two of the six exceed the S mean rainfall by two standard deviations and dominate the outcome of the experiment. As mentioned earlier, deletion of the wettest S ($105,504 \times 10^3 \text{ m}^3$) and wettest NS ($17,709 \times 10^3 \text{ m}^3$) units as a sensitivity test gives a revised S ($8,134 \times 10^3 \text{ m}^3$) to NS ($5,104 \times 10^3 \text{ m}^3$) ratio of rain volumes of 1.59 at a P value of 0.040. Thus, with the deletion of the wettest unit from each sample the apparent seeding effect, although considerably smaller, still has a P value < 0.05 .

The unit findings were partitioned by the supercooled rainwater (SCR) index and the results are presented also in Table 3. The SCR index was selected to see whether the apparent effect of seeding was affected by the intensity of in-cloud coalescence. Before discussing these results, some background information is in order.

The cold-cloud conceptual seeding model indicates that the optimal cloud structure for seeding intervention is a strong updraft containing low concentrations of raindrops generated from below by coalescence interspersed within high quantities of cloud water. Supercooled clouds without raindrops are not viewed as optimal because glaciation and the growth of graupel to precipitation size proceeds more slowly in such clouds, even with seeding intervention (Rosenfeld and Woodley, 1993). Conversely, clouds low in cloud water and laden with raindrops are not optimal either because such clouds usually glaciate at -10°C or even warmer through natural droplet freezing and ice multiplication, resulting in the early formation of precipitation.

Rosenfeld and Woodley (2001) have investigated the importance of coalescence in the production of rainfall from Thai convective rain cells. The radar estimates of the properties of non-seeded cells were partitioned using in-situ observations of detectable raindrops on the windshield of the project AeroCommander seeder aircraft as it penetrated the updrafts of growing convective towers, 200 - 600 m below their tops at about the -8°C level (about 6.5 km MSL). Cells observed to contain detectable raindrops during these aircraft penetrations were found to have smaller first-echo depths than cells without observed raindrops when growing through the aircraft penetration level. This faster formation of raindrops is attributed to a rapid onset of coalescence in the convective cells.

It was noted that convective cells exhibiting a rapid onset of coalescence produced over a factor of two more rainfall than cells in which the onset of coalescence was slower (no detectable raindrops when growing through the aircraft penetration level). These findings highlight the important role that coalescence plays in the production of rain from clouds.

These results were extended to the evaluation of the seeding experiments. On each day of unit qualification the percentage of cloud passes on which raindrops were observed to impact the aircraft windshield was calculated. A scale of coalescence intensity was developed from the measurements, ranging from 0% of the passes with detectable raindrops (weak coalescence) up to 100% of the cloud passes having detectable raindrops (strong coalescence). Six classes were defined in all (0%, 0% to 9%, 10% to 49%, 50% to 89%, 90% to 100% and 100%). Note that the second and fifth categories overlap with the first and sixth categories, respectively.

Despite the small sample and enormous variability within each partition, the partitioned unit results are very interesting. (The S/NS values in parentheses were obtained after adjusting the results for the natural rainfall biases as discussed later in this report. The largest and most significant apparent effect of seeding is seen on days when the SCR index was $< 50\%$, that is, on days when less than 50% of the cloud passes had detectable raindrops. On days when raindrops were much more prevalent the apparent effect is much smaller without P-value support. Again, the results suggest there is not much point in seeding clouds when they are laden with raindrops.

Because the effect of seeding is strongly dependent on cloud structure, the importance of using AVHRR satellite imagery and the method of Rosenfeld and Lensky (1998) to specify the cloud structure is readily obvious. This was done for Texas during the summers of 1999 and 2000 as a precursor to the estimation of the potential effects of seeding over the State.

Because the sample is dominated by six large units, especially those qualified in 1998, some means should be used to adjust for year effects. One approach is normalization of the unit RVOL values for each year. This involves calculating the ratio of the mean yearly NS rainfall to the mean NS rainfall for all years. This ratio is then applied to all the unit rainfalls for that year. Then, the overall seeding effect is the ratio of normalized S to NS rainfalls.

This scheme accounts for year-to-year differences in rainfall, which might have natural or artificial causes (e.g., radar mis-calibration that survived the clutter re-calibration). Normalization also compensates for a disproportionate draw of a particular treatment decision in a given year that might be overly dry or wet. In so doing, it changes the unit values within each year but preserves the seed vs. no seed relationships and makes it possible for all years to compete on an equal footing. Put colloquially, normalization "levels the playing field."

The normalization analysis, using mean NS rainfalls for the unit lifetimes as the reference (i.e. mean NS unit RVOL = $5,404 \times 10^3 \text{ m}^3$) shows 1993, 1995 and 1997 as drier than the overall NS sample mean and 1994, 1996 and 1998 as wetter than the overall NS sample. The normalization factors by year since 1993 are 2.790, 0.675, 1.378, 0.692, 1.554 and 0.774. Only one unit was obtained in 1991 and a normalization factor of 1.0 was used for that unit.

Applying these yearly normalization factors produced mean normalized rain volumes for the unit lifetimes of $10,157 \times 10^3 \text{ m}^3$ for the S sample and $5,403 \times 10^3 \text{ m}^3$ for the NS sample, giving a ratio of 1.88 at a P value of 0.009.

The radar-estimated rain increment for the duration of the experimental units, regardless of whether one uses normalized or non-normalized data is nearly 5,000 kilotons (i.e., $5 \times 10^6 \text{ m}^3$)

or 4,050 acre-feet of water per seeded unit. If real, this would represent a substantial impact on water supplies. As mentioned earlier and to be shown in more detail in subsection 8.3, the apparent seeding effect in Thailand probably has been aided by the natural rainfall variability.

8.2 Time Plots of Unit Rainfalls

Plots of mean unit rain volume rate (RVR) and mean cumulative rain volume (RVOL) relative to the time of unit qualification are provided in Figures 3 and 4, respectively. The plots give the S and NS values from two hours prior to unit qualification to 8 hours subsequently. The cumulative RVOL plot (Figure 4) was obtained by integrating forward and backward from the time of unit qualification such that the pretreatment accumulations are shown as negative.

Beginning with the RVR plots (Figure 3), note the S RVR exceeds the NS RVR before treatment with a maximum at -30 minutes. This disparity had diminished greatly by the time of unit qualification. After qualification the NS RVR plot exceeds the S RVR plot early in the treatment period (Figure 3). From 80 minutes after unit qualification onward, however, the S plot exceeds the NS plot out to 480 minutes, reaching a secondary peak at 400 minutes.

Integration of the RVR values with time gave the cumulative RVOL plots shown in Fig. 4. Note there is a pre-qualification bias favoring the S cases. The mean difference in cumulative S and NS rain volumes is only $194 \times 10^3 \text{ m}^3$ by 120 minutes before unit qualification. This average difference is less than the rain volume from a typical NS cell, which averages $243 \times 10^3 \text{ m}^3$. In the period 0 to 80 minutes the mean cumulative RVOL plots are virtually coincident. After that the lines diverge out to 480 min. By the end of the period of evaluation, the S to NS ratio had increased to a factor of 1.92.

It is obvious from these plots that natural rainfall bias played a role in the Thai experiments, as it does in virtually all experiments having rather small samples. This was the feeling when first determining that the S to NS ratio for the duration of the experimental units is 1.92, which is a very large apparent effect of seeding. The challenge is in accounting for this bias. It is definitely not as simple as forming the double ratio between the post- and pre-qualification single ratios. This would only be valid if the pre- and post-qualification rain volumes are highly correlated. This is not the case. The correlation is only 0.18 for the 30 min immediately prior to unit qualification and 0.23 for the cumulative rain volume in the 120 min before qualification.

An interesting aspect of the time plots is the suggestion that seeding effects persist for several hours after seeding has ceased. This can amount to 6 hours. In that time frame the clouds will have moved well downwind of the initial seeding. In Texas where the echo motion averages 10 to 15 kts, the initial seeded clouds have moved 60 to 90 n.mi. downwind and in many cases well outside the target area. This reality must be considered when estimating the potential impact of cloud seeding in Texas.

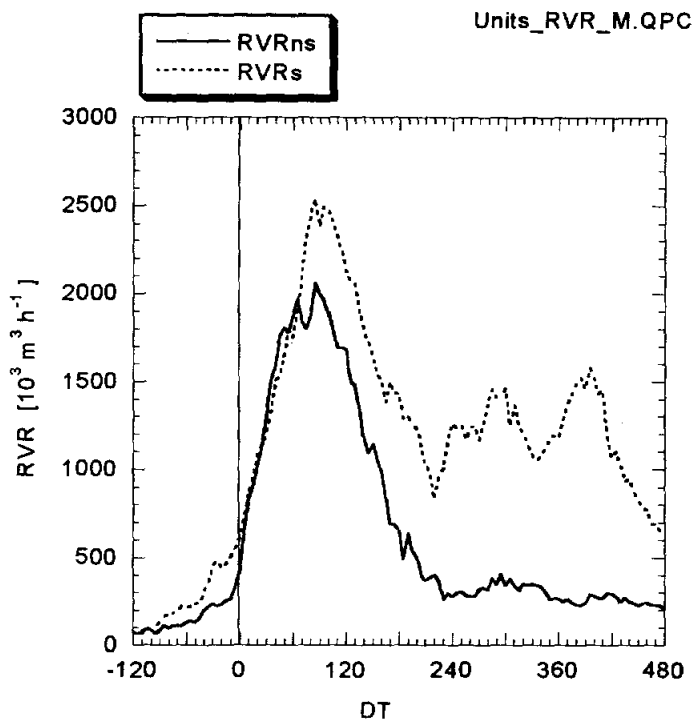

Figure 3. Plots of S and NS mean RVR values vs. time interval after unit qualification for the cold cloud experimental units obtained in Thailand in the period 1991-1998.

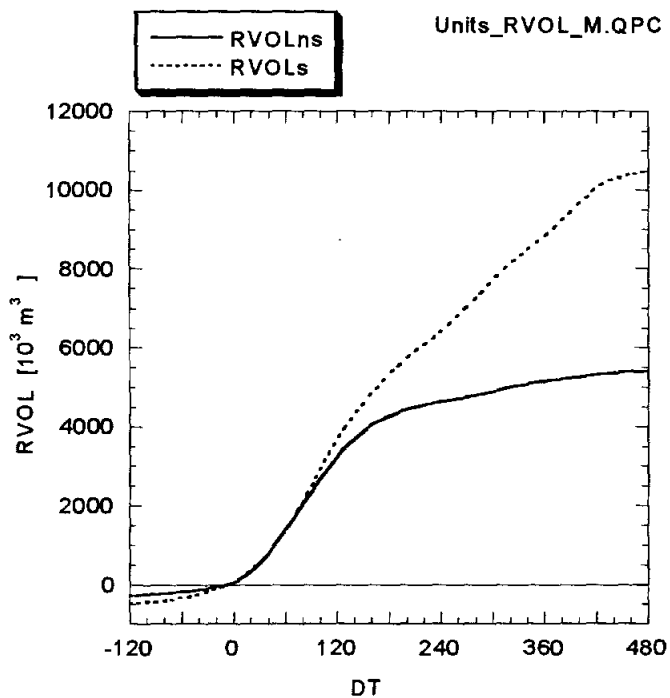

Figure 4. Plots of mean integrated S and NS RVOL values vs. time interval after unit qualification for the cold cloud experimental units obtained in Thailand in the period 1991-1998.

8.3 Attempts to account for the natural rainfall variability

The variability of the natural rainfall in any cloud seeding experiment is always considerably greater than the claimed seeding effect. Using the Thai experiment as an example, the smallest non-seed unit rainfall was $0.02 \times 10^6 \text{ m}^3$ whereas the largest was $17.71 \times 10^6 \text{ m}^3$. Thus, the largest and smallest unseeded units in the small Thai sample differ by a factor of 886. Such natural rainfall variability is typical of virtually all cloud seeding experiments, and it can "bury" any effect of seeding. That is why all cloud seeding experiments employ randomization for the selection of seeding units. In theory, randomization can mitigate the deleterious effect of natural rainfall variability if the sample is large enough such that very wet and very dry days are allocated equally to the Seed and No Seed samples. In the real world, however, experiments rarely go long enough to negate the effect of the natural rainfall variability, which confounds their interpretation. Statistical procedures are not a panacea for this problem. There is always a finite probability that the randomization favored one treatment category with a disproportionate assignment of naturally wet days. Under such circumstances an effect of seeding might be inferred even though seeding had no effect on the clouds. In statistical parlance this is called a "Type I" error.

If one is to engage in weather modification experiments, there must be two objectives. First, there must be a commitment to conduct the experiments long enough to obtain the needed sample, which can be estimated in advance if the natural rainfall variability is known. Second, there must be major effort to develop good predictive relationships for the natural rainfall. The better the predictive equations the smaller the sample can be. In the perfect world only a small sample might be needed if the predictive equations are perfect predictors. In this eventuality, the evaluation of cloud seeding experiments becomes a trivial exercise. One need only conduct the experiments and compare the results to the predicted rainfall. The disparity between what is observed and what was predicted is the seeding effect. Unfortunately, no experiment to date has been able to cope with the natural rainfall variability so simply.

Woodley and Rosenfeld (2001) addressed this problem through multiple linear regression using covariate variables as input. The best two proved to be the precipitable water (PW) through the depth of the atmospheric column and the mean control cell rainfall, calculated external to the units on each day. (The pre-qualification rainfall biases did not figure significantly in the regressions.) Their correlations with the lifetime unit rainfalls are only 0.363 and 0.458, respectively. Their multiple correlation with the lifetime unit rainfalls is 0.543, which means that these two covariate variables account for only 29% of the rainfall variability.

The results of the regression exercise are summarized also in Table 3. Note that the ratio of predicted S to predicted NS unit rainfalls is 1.34 suggesting that the natural rainfall variability favored the S sample by 34%. Thus, the apparent effect of seeding is the double ratio between the observed apparent seeding effect (1.92) and the natural rainfall bias (1.34). The result is an apparent seeding effect of 1.43 or +43%. This is a conservative estimate of the effect of seeding on the unit scale in Thailand. This is the value that will be used in the studies to make a conservative estimate of the potential impact of cloud seeding in Texas.

It is interesting that the best estimate of seeding effect in Texas that was obtained before termination of the randomized seeding experimentation was 1.45. Thus, the revised, conservative, estimate of seeding effect in Thailand and that in Texas are in good agreement. In addition, the apparent effect of seeding in FACE-1 (Woodley et al., 1982) for the large floating target was +46% and in Cuba the apparent effect of seeding on the scale of cloud clusters was +43%. Although this general agreement among the estimates of seeding effect does not assure that any of them are correct, it does support the base estimate of seeding effect for areas of about 2,000 km² to be used in the study for the TWDB. As will be seen, however, as area size increases the hypothetical increases due to seeding will decrease.

Finally, the estimates of seeding effect as a function of the SCR presented in Table 3 were revised downward by 34% (i.e., division by 1.34), based on the overall regression analysis. These estimates are provided in parentheses by SCR category. These are the conservative values that will be used for the TWDB studies.

8.4 Summary

Careful consideration of the results presented in Task 1 has taught us the following with respect to the seeding of warm season convective clouds:

- The evidence for seeding-induced rainfall increases from individual convective clouds is fairly strong.
- Proof of seeding-induced area rainfall increases does not yet exist.
- Although the evidence for seeding-induced rainfall increases over fixed and floating target areas is weaker, it has been judged strong enough by users of the technology to warrant operational cloud seeding during drought conditions.
- The effects of seeding are variable in space and time, due in part to changes in the cloud microstructure.
- Most experiments probably have produced inconclusive results, because clouds with varying microstructure and, therefore, varying responses to seeding were seeded and grouped together during the analysis phase.
- Future experiments should consider cloud microstructure during the seeding operations and especially during the analyses.
- The assessment of seeding opportunities in Texas must take cloud conditions into account.

These results and insights provide the basis for Tasks 2 and 3.

9.0 THE TEXAS OPERATIONAL CLOUD SEEDING PROGRAMS

9.1 Introduction

The overriding goal of this research effort for the Texas Water Development Board is the systematic assessment of cloud seeding as a water management tool for Texas. This has not been done before. Considering that ten operational cloud seeding programs were in operation as of July 2001, it would seem in one sense that someone has the “cart before the horse.” Although the managers of these projects are aware of the uncertainties surrounding cloud seeding, they

decided to proceed because they believed that the potential benefits would exceed the project costs. For this reason, it is important to take a closer look at the history of operational cloud seeding in Texas. The information to be presented next was excerpted from the paper by Bomar et al., (1999). Dr. Woodley was its second author.

9.2 Background

Texas suffers from periodic droughts. This will always be the case in view of the semi-arid nature of the climate of much of the state. The most recent period of severe rain deficiency began in 1995 and continued through 1999 into 2000. Coping with such dry periods in the future will become increasingly difficult in Texas because of its growing population, which is predicted to nearly double, to 35 million, by the year 2030 AD.

This growing need for adequate fresh-water supplies in arid and drought-stricken parts of Texas has focused renewed attention on alternative ways of conserving existing water resources and of procuring additional water by tapping into the abundant supply of moisture available in the Earth's atmosphere. Passage of the Texas Weather Modification Act by the Texas Legislature in 1967 was a tacit acknowledgment that the use of cloud-seeding technology had earned a measure of acceptance within the water-management community in Texas. At the same time, the law recognized many uncertainties remained with respect to the effectiveness of various forms of cloud seeding. Hence, the need to regulate the level of human intervention in cloud processes to protect the interests of the public, and to promote the development of a viable and demonstrable technology of cloud seeding, was addressed by that legislative act.

To attain the objective mandated by the Texas Legislature to develop and refine cloud-seeding technologies, the State of Texas took a first step by linking up with the U. S. Bureau of Reclamation in 1973 to devise and demonstrate a viable cloud-seeding technology. Since then, an on-going, though often intermittent, research effort has ensued to corroborate and quantify the effects of timely seeding of convective clouds. Despite limited funding over the years, substantial progress has been made in pursuit of this goal.

Texas also has a long history of operational weather modification. From the time prior to World War I, when C. W. Post attempted to 'shake' rainwater out of towering cumuli along and just below the Caprock region of West Texas (1911-1914), various weather-modification methodologies have been used in the Lone Star State to prompt warm-season cumulus clouds to live longer and shed much-needed rainfall. Rain-enhancement projects sprung up intermittently in parts of semi-arid West Texas in the decades between the two world wars and during the epic drought of the 1950s, usually as a measure of last resort to ameliorate the impact of a prolonged dry spell. Even after legislation was adopted in 1967 to regulate the use of cloud-seeding technology within the state, rain-enhancement programs adopted by various water interests were for the most part locally controlled and funded, with minimal interface from the State.

The lack of state involvement in the more than a dozen independently financed and managed weather modification projects prior to 1970 meant that the bulk of these efforts received a minimum of rigorous analysis. In fact, most of the projects were poorly documented, if at all. The impact of cloud seeding was seldom quantified, and perceptions of the efficacy of

the efforts were for the most part a function of who happened to be asked. By today's standards, methods of cloud seeding were rather primitive. For instance, many of the projects conducted between World War II and the passage of the Texas Weather Modification Act (in 1967) involved WWII-vintage aircraft and dry ice.

9.3 Role of Water Districts

What would eventually serve as a foundation for funding, designing, and implementing cloud-seeding operations on a large-scale basis in Texas began to evolve during the historic 1950s drought. Independent *water districts* began sprouting in rain-short areas of West and Southwest Texas after a precedent was established in the mid-1950s by the High Plains Underground Water Conservation District. This district, encompassing all or parts of 15 counties in northwestern Texas and covering some 6.9 million acres above the Caprock, materialized in order to monitor, and eventually govern, the use of fresh water from the vast Ogallala Aquifer that underlies vast portions of the U. S. Great Plains from Nebraska to near the Permian Basin in far West Texas. Given *ad valorem* taxing authority, the District was furnished the financial wherewithal to set up a staff to quantify its ground-water resources and regulate the use of that ground water to ensure that water supplies from the aquifer would be adequate to meet the fresh-water needs of a growing populace.

Subsequent state legislation encouraged the formation of other, similarly-constructed water districts in semi-arid parts of Texas, though the 42 districts formed after 1985 (and encompassing all, or parts, of 80 Texas counties) were considerably less expansive than the original High Plains district based in Lubbock. In every instance, however, the fundamental motivation for establishing these districts (many of which are single-county districts) was to have a legal mechanism in place to control the draw-down from, and abet the recharge to, the aquifers that underlay the districts. Perhaps serendipitously, the arrangement of these districts afforded the locals a fiscal mechanism by which programs like cloud seeding for rainwater-augmentation could be equitably paid for within their respective areas of jurisdiction.

The first water district to use some of its funds to apply an innovative water-development strategy, such as precipitation enhancement through cloud seeding, was the Colorado River Municipal Water District, based in Big Spring. The formation of two reservoirs on the upper Colorado River of Texas, owned and maintained by the CRMWD, and subsequent sale of water from those lakes, created the need for additional runoff. One of Texas' preeminent pioneers in developing new and innovative water-management strategies, Owen H. Ivie, as general manager of the CRMWD, launched a cloud-seeding program in 1971.

For several years, the CRMWD seeded clouds over an area of 3500 square miles (2.24 million acres) of West Texas using a weather-modification contractor. Eventually, the CRMWD committed to a long-term rain-enhancement program by securing its own aircraft, weather radar, and qualified staff to run its cloud-seeding operation during the growing season. By renewing its Texas weather-modification license and permit from the State water agency, the CRMWD maintained its cloud-seeding program for two decades, until it suspended operations for one season (1989) due to extremely wet conditions within its 14-county operational area. It resumed

its program in 1990 and has continued ever since, becoming one of the longest-running rain-enhancement projects in the world.

The CRMWD systematically documented its cloud-seeding operations, including an annual assessment of the impact of the seeding operations on runoff over the watersheds of its two reservoirs, although the analysis would not meet the standards articulated in Section 6.4 and in Appendix A. It set up and maintained its own dense network of fence-post rain gages. Data from these gages were analyzed at the end of each year's 7-month-long program; moreover, the staff collected and analyzed crop-yield data (primarily cotton production) each year within its 14-county operational area and smaller "target" area (Jones, 1985). Repeated studies of these data revealed apparent sizable rainfall increases within, and downwind, of the target area. For all years during which seeding was conducted, rainfall was observed to have increased between 20 and 35 percent within the target area during the growing season, with lesser increases noted in areas adjacent to the watersheds of the two reservoirs.

The apparent success of the CRMWD weather-modification program encouraged other water interests to emulate the approach taken by the Big Spring organization. The City of San Angelo sponsored a 5-year cloud-seeding project during 1985-1989 to generate more runoff over the watershed of its reservoir system west and south of the city. For the first time in Texas, however, glaciogenic seeding material was disseminated using pressurized aircraft operating at or above cloud top. Silver iodide flares were ejected from the bottom of the aircraft fuselage during seeding missions. An historical target-control regression analysis of rainfall within and beyond the project's target area indicated seasonal rainfall during the 5-year period exceeded the long-term average by as much as 27 to 42 percent (Woodley and Solak, 1990). It must be emphasized, however, that the cloud seeding in the San Angelo target was not randomized, making it susceptible to bias in its conduct and evaluation. Further, the validity of historical target-control regressions has been called into question by Gabriel (1999a).

9.4 Origins of a Statewide Program

Despite the apparent successes of the two multi-year projects based in Big Spring and San Angelo, it was not until 1995 that interest in using cloud-seeding technology grew enough to foster serious consideration of implementing a far-reaching, regionwide cloud-seeding effort. The impetus for a statewide weather-modification program was born in the region west of San Angelo, where cloud seeding had been conducted extensively in the latter half of the 1980s. During that 5-year program, numerous ranchers living west of the city in several counties whose rivers and streams supplied water to the City's reservoir system had observed what they considered to be a positive response in many of the towering cumuli seeded by the City's contractor. These counties already had in place single-county water districts, which afforded a convenient mechanism for raising funds to support the reinstatement of a regionwide cloud-seeding program.

Water-district officials from these counties began holding public meetings in and near their respective county seats and invited staff from the State's water agency to attend and give formal presentations on the state of weather-modification technology for rainfall-augmentation. Landowners and water-district officials in Irion and Crockett Counties of West Texas learned

more about the potential of cloud seeding for augmenting rainfall in the summer of 1995, at which time the State's water agency was conducting a series of cloud-seeding experiments in the Big Spring, Texas area. The experiments, known as the Texas Exercise in Augmenting Rainfall through Cloud-seeding (TEXARC) Project, were designed to document the microphysical processes in growing convective clouds that were being seeded with either glaciogenic or hygroscopic materials.

As a severe drought ravaged much of West Texas in 1995, other nearby counties joined with Irion and Crockett Counties to form the West Texas Weather Modification Association (WTWMA). Its purpose was to raise funds and implement cloud seeding operations. This Association was formed under the authority given the water districts to quantify and protect ground-water reserves in the aquifers beneath them. Cloud seeding was viewed by these officials as a cost-effective means of recharging the aquifers and lessening the rate of withdrawal from the aquifers. The establishment of this alliance of eight counties to promote the use of cloud-seeding technology would serve as a prototype for other rain-enhancement projects that would form elsewhere in West, and in South, Texas in the years to follow. With a "target" area of 7.2 million acres, a contractor was identified and both cloud-base and cloud-top seeding activities got underway in May 1996.

9.5 Local Supervision of Seeding Operations

An executive Board consisting of representation from the eight participating counties was established to facilitate decision-making as the project ensued. Despite the fact that some counties making up the WTWMA target area were considerably larger than others, each county was assigned one vote. Moreover, each voting delegate had to be an elected official (e.g. water district Board member, county commissioner, city official). Such a policy ensured that control of the program resided, and was maintained, at the "grass-roots" level. Furthermore, the program was paid out of revenue raised, through *ad valorem* taxes, by each county. A county share's was determined by the total amount of acreage in that county. In one or two instances, where counties without water districts were participants, the share of funding from that county was provided by a county commissioners' court or through revenue supplied by a landowners' association.

The first year of cloud seeding was paid solely by monies raised by the water districts constituting the WTWMA. The way these member counties linked themselves together to plan and pay for the rain-enhancement project garnered the attention of both regional and national news media. The fact that the region was in the throes of a worsening and spreading drought undoubtedly contributed to the fascination shown by both media groups and by political interests statewide. In the early weeks (June 1996) of the newly formed cloud-seeding operation based in San Angelo, reporters from several major television news organizations (ABC, CBS, CNN, and NBC) visited the project site to interview project organizers and personnel. Several major newspapers (including the Dallas Morning News) did feature articles on the project as well.

Perhaps the most appealing aspect of the way the West Texas group organized themselves consisted of the control afforded the program at the local level. The executive Board made all decisions relative to the conduct of the program. Representation from each participating

county meant the diverse needs of each major enterprise could be accommodated. For instance, a county with a heavy investment in cotton production would prefer to have a minimum of rainfall during the time of harvest in the autumn; input from that county through its representative on the Board would ensure that the county (or some large sector of that county) would be excluded from any advertent weather-modification activity during the period specified.

The West Texas group had as its preeminent objective to help as many as possible residing within their target area and not to hurt anyone. In fact, the State water agency regulating the use of cloud seeding for rain enhancement is required to ascertain, to the extent technologically possible, that the proposed weather-modification program will not "dissipate the clouds nor prevent their natural course of developing rainfall in the area to the material detriment of people or property" within that area; such a finding must be made before the Texas Natural Resource Conservation Commission (TNRCC) can, and will, issue a permit for the project.

Moreover, the WTWMA maintained a rain-gage network to assess soil-moisture conditions during the course of the cloud-seeding operation. These rainfall data were used to prioritize those areas within the target region most, and least, in need of rainfall. In many instances, it was possible to specify an area as small as a fraction of a county where rainwater was, or was not, needed. This policy afforded the participating counties, and ranchers within them, an added sense of control of the program.

9.6 The Proliferation of Rain-Enhancement Projects

Using the WTWMA organizational model, a second rain-enhancement program was formed in South Central Texas, south of San Antonio and some 250 miles removed from the WTWMA site. A water district (known as the Evergreen Underground Water Conservation District) based in Jourdanton, Texas served as the nucleus for this 7-county, 4.4 million-acre project. The alliance of counties, called the South Texas Weather Modification Association (STWMA), established a governing Board, developed specifications for a warm-season rain-augmentation program, went out for bid, then secured a contracting firm to perform the actual seeding operations.

A third rain-enhancement project, covering some 6.87 million acres in the Texas High Plains, materialized in 1997. This project, based in Lubbock, was unlike its two predecessors in that it was sponsored by a lone and very large underground water-conservation district covering all or parts of 15 counties in the High Plains of Texas. That district, the HPUWCD, already had in place a governing board as well as a network of county committeemen. Those two mechanisms were used to provide the kinds of locally based input needed to structure, then supervise, the cloud-seeding program to the needs of constituents.

Still more projects, encompassing an additional 12 million acres in southwest and south Texas, were drawn up for implementation in 1998. One of them got underway just weeks before the residue from a tropical storm (Charlie) dumped flash floods in Val Verde County, the heart of the Texas Border Weather Modification Association (TBWMA) target area. (Cloud-seeding operations had been suspended a full 20 hours before the onset of those torrential, flood-

producing rains inundated much of the city of Del Rio in August 1998.) The project, governed similarly by a multi-county Board, resumed cloud seeding soon after the floodwaters receded.

Two additional projects were in operation by the 2000 season, bringing the total to nine projects. The new projects were in the northern Texas Panhandle. One was centered in Dumas and the other in Pampa. The tenth seeding project, centered in Abilene, Texas, began during the 2001 season.

9.7 State Support of Weather Modification

A pivotal development in the statewide weather-modification program can be traced to action by the 75th Texas Legislature, which in 1997, appropriated for the first time ever a substantial amount of funds to help the various cloud-seeding projects pay for their operations. The State support was given to those water districts sponsoring cloud seeding on a 50-50 cost share, or match, basis. The amount of State funding to each project was determined strictly on a per acreage basis. This arrangement meant that, for every \$0.0425 per acre raised at the local level, an equivalent amount was contributed by the State water agency (TNRCC). Funds totaling \$4.197 million were also made available for operations during the warm seasons of 1998 and 1999.

To unify the various rain-enhancement projects within Texas, an 'umbrella' organization was formed in 1997 known as the Texas Weather Modification Association. A voting representative from each of the state's five operational cloud-seeding programs served on the Association's executive Board. The TWMA worked to resolve problems encountered with the use of various types of flares at the five project sites. Moreover, the association advises the TNRCC staff in the allotment of state revenue to help pay for the weather-modification programs. The group also sponsored training sessions for project personnel, including specialized training from a scientific consultant for those meteorologists running the programs.

The end result of the collaborative efforts of state and local officials to orchestrate a well-designed, coordinated weather-modification effort for the state of Texas has fostered a virtually ideal environment for continued research into, and development of, an appropriate cloud-seeding technology for the region. This was evidenced by the successful completion of the 1998 TEXARC Project in the vicinity of San Angelo, Texas. It is also apparent in continued monetary support from the State water agency, with the bright prospect that State funding can, and will, be maintained through at least the summer of 2001 for both operational cloud seeding activities and relevant research and assessment work in support of those activities.

10.0 TASK 2 METHODOLOGY AND RESULTS

The earlier presentation in Table 3 of seeding effects in the Thai experimentation indicated that the effect of seeding depended in part on the intensity of coalescence in the clouds. It is obvious, therefore, that if one is to identify seeding opportunities in Texas one must first specify cloud microstructure. This is possible now through the analysis of AVHRR satellite imagery to determine the effective radius (r_e) vs. temperature of a cloud population in the manner described by Rosenfeld and Lensky (1998). An example of this process is illustrated in

Figure 5 for June 1, 2000. Superimposed on the image are portions of the targets for the West Texas (right corner), CRMWD (right center) and High Plains (upper right) operational seeding programs. The three insets on the left are the plots of the effective radius (r_e) vs. temperature for the three boxes shown in red. Plot 1 is applicable to the High Plains, Panhandle and CRMWD targets. Upon examining the plot, it was determined from the objective method algorithm that glaciation occurred on average in the range -15°C to -20°C . Further, the cloud particles reached an effective radius of 15 microns in the range $+5^{\circ}\text{C}$ to -5°C , where 15 microns is the precipitation threshold for a population of drops, although drops of that size are obviously not precipitating. As will be seen momentarily, the clouds in these targets get a classification or ranking of 3.

Thus, the first step in Task 2 involved the processing of the data for each of the Texas seeding targets and then the assignment of a microphysical cloud classification for each of the days that data were available. This was done using the cloud classification matrix in Table 4. Note that targets having clouds on a given day with intense supercooling and/or no coalescence have a classification of 1 whereas targets having clouds with warm glaciation temperatures and/or early warm glaciation have a classification of 5. These are the two extremes. The former are said to have a "continental" character while the latter are described as "maritime."

To obtain the cloud classification for the targets in Figure 5 first note that the plots indicate that the clouds on this day were glaciating at temperatures of -15°C to -20°C and producing raindrops in the range of $+5^{\circ}\text{C}$ to -5°C , where the clouds reached an effective radius of 15 microns. Now go to Table 4 and determine where a glaciation temperature range of -15°C to -20°C intersects the coalescence temperature range of $+5^{\circ}\text{C}$ to -5°C . Note that the intersection is uniquely at a cloud classification of 3.0. It will be seen later that the best estimate of seeding effect for clouds having this classification is a factor of 2.74.

The target classifications for 1999 and 2000 are provided in Appendix B. The imagery from which the classifications were made is available on CD-ROM. The coded entries in the Appendix B tables have the following interpretation: 1) E means Texas was on the edge of the image and no inferences of cloud structure could be made, 2) C means the identified target was clear of clouds, 3) LyrC means the target was covered by layer clouds, 4) Ci means only cirrus was present in the target, 5) Smlc indicates that only small cumuli were present in the target, 6) BD means bad data and 7) TS means that cloudiness from a tropical storm was present in the affected target. In some cases the inference of cloud structure for a specific target could not be made and the rating had to be extrapolated from clouds around the target. These data open up many possibilities for understanding Texas convection and its response to seeding.

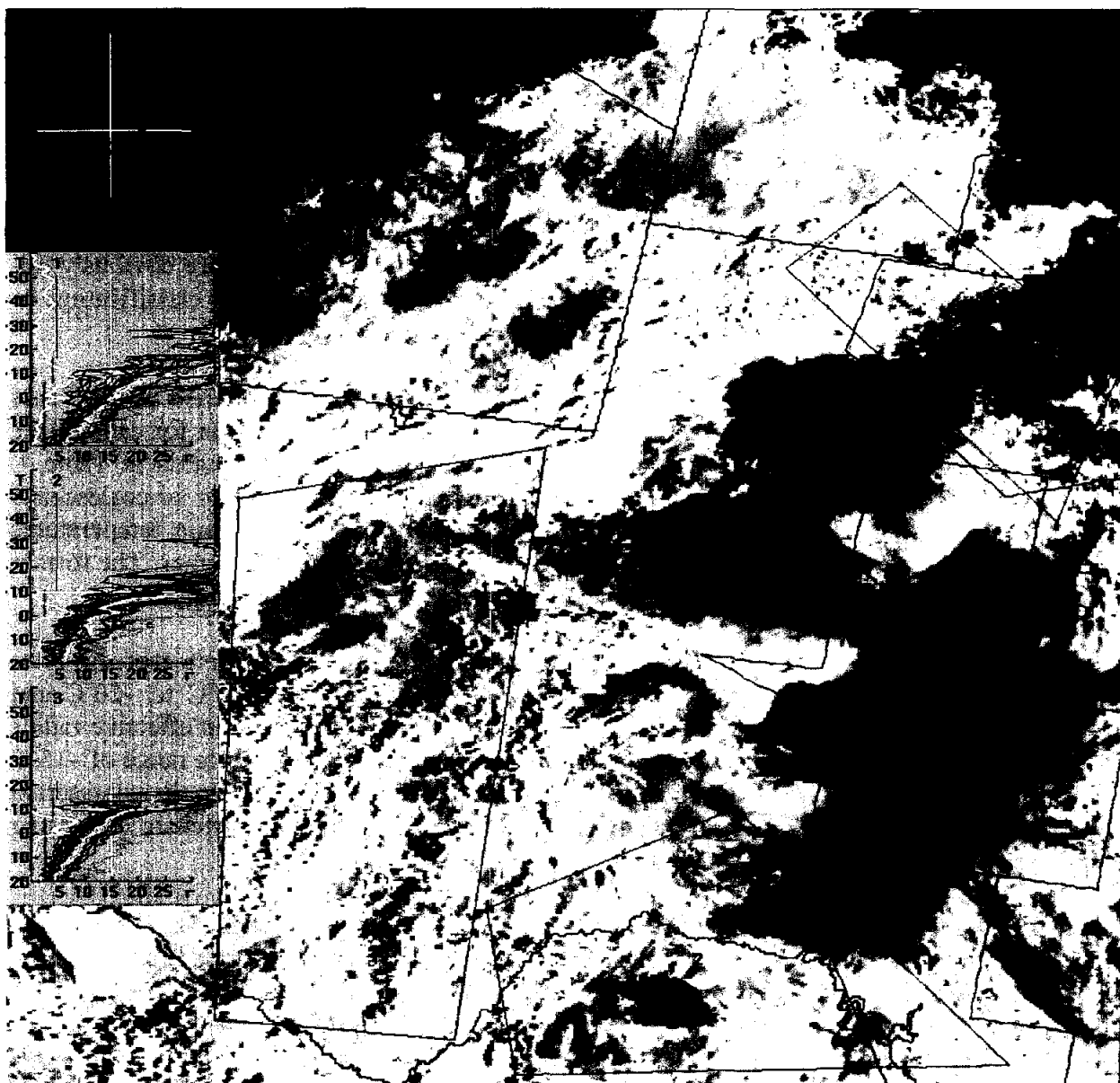

Figure 5. Processed AVHRR image at 2243 GMT on June 1, 2000. According to the usual color classification, the yellow cumuliform cloud elements indicate they are composed of supercooled droplets while the red areas are the “anvils” of the cumulonimbus tops. The insets show the T vs. r_e plots for the three red-bordered polygons in the image. The colored vertical bars refer to the inferred microphysical zones, where yellow is the diffusional growth zone, green is the zone of coalescence, magenta is the mixed phase zone and red is the glaciated zone. The 10 percentile lines for the pixels having r_e for a given T are plotted. The plot in white is the pixel sample size versus temperature.

Table 4
Cloud Classification Matrix of Rankings

Glaciation Temperature (°C)	Temperature (°C) when r_{eff} first equals 15 microns				
	$T \geq 15$	$15 \geq T > 5$	$5 \geq T > -5$	$-5 \geq T > -15$	$T \leq -15$
$T > -10$	5.0	4.5	4.0	3.5	3.0
$-10 \geq T > -15$	4.5	4.0	3.5	3.0	2.5
$-15 \geq T > -20$	4.0	3.5	3.0	2.5	2.0
$-20 \geq T > -25$	3.5	3.0	2.5	2.0	1.5
$T \leq -25$	3.0	2.5	2.0	1.5	1.0

A comparison of the monthly and seasonal satellite cloud classifications for the seeding targets in 1999 and 2000 is provided in Table 5. The Panhandle and North Plains targets were not defined at the time of analysis of the 1999 data and no information is available for these targets in 1999. The data are very limited in some months, due either to a lack of clouds and/or data. In looking at the "overall" column (the second column from the right) both years show an increase in cloud classification from northwest to southeast through Texas. This means that the clouds in Texas become more maritime in character, having increasing coalescence and warm glaciation temperatures as distance from the Gulf Coast decreases. This is an expected result. The rightmost column of Table 5 is the overall seasonal seeding effect by year, obtained by converting the overall cloud classification to seeding effect as described below.

Table 5. Mean Convective Rankings for the Texas Operational Seeding Targets
By Month and Overall for April through September in 1999 and 2000
(The first number in the set is sample size in days and the second number is the mean cloud classification.)

Target	April	May	June	July	August	Sept.	Overall Cld Cls	Overall Seed Eff
NP00	7, 1.3	6, 1.3	16, 1.9	5, 2.2	2, 2.0	4, 1.4	40, 1.8	1.7
PG00	8, 1.4	6, 1.3	16, 2.2	5, 2.1	2, 2.0	4, 1.4	41, 1.8	1.7
HP99	5, 1.4	9, 1.9	16, 1.6	7, 2.3	16, 1.9	12, 2.1	65, 1.9	1.7
HP00	8, 1.4	10, 1.5	19, 2.2	7, 2.8	2, 2.8	4, 1.4	50, 2.0	1.7
CR99	6, 1.2	12, 1.8	15, 1.8	11, 2.9	12, 1.8	12, 2.4	68, 2.0	1.7
CR00	5, 1.2	5, 1.5	14, 2.6	9, 2.3	2, 2.3	4, 1.6	39, 2.1	1.8
WT99	4, 1.6	10, 2.1	15, 2.2	9, 2.4	14, 1.9	13, 2.5	61, 2.3	2.0
WT00	7, 1.1	7, 1.3	13, 2.6	9, 2.4	1, 2.0	5, 1.7	42, 2.0	1.7
TB99	4, 1.3	7, 1.9	10, 2.8	5, 2.8	7, 2.0	9, 3.0	42, 2.4	2.1
TB00	7, 1.4	5, 1.4	9, 3.6	4, 2.1	2, 2.5	4, 1.4	31, 2.2	1.9
EA99	1, 2.5	4, 2.5	8, 2.7	10, 2.8	7, 2.1	12, 2.8	42, 2.6	2.3
EA00	3, 2.3	2, 2.5	10, 3.3	5, 2.4	4, 3.0	4, 2.4	28, 2.8	2.5
SWT99	2, 2.5	4, 2.8	8, 3.2	12, 3.6	6, 2.6	9, 3.4	41, 3.2	2.4
SWT00	1, 1.0	1, 1.5	9, 3.4	2, 2.8	4, 3.0	3, 2.5	20, 2.9	2.6
ST99	1, 2.5	5, 2.9	8, 3.2	13, 3.3	5, 2.4	10, 3.4	42, 3.1	2.6
ST00	1, 1.0	3, 2.3	10, 3.3	4, 3.1	3, 3.0	3, 3.0	24, 3.0	2.7

The next step in the recognition of seeding opportunities was the conversion of the convective rankings to hypothetical seeding effects using the information in Table 6. The first column is the Daily Coalescence Rating and the second is the corresponding Supercooled Rainwater Index that was discussed earlier. Column 3 gives the hypothetical Seeding Factor corresponding to the Supercooled Rainwater Index. The values are the scaled-back estimates provided in parentheses in Table 3 for the Thai cold-cloud experiment. These were obtained by dividing the raw values in Table 3 by 1.34 to account for the natural bias favoring the seed cases. Again, note that the Thai experimentation suggests that the largest apparent seeding effect comes in clouds with weak to moderate coalescence, and the effect falls off rapidly thereafter. The last column provides the relationship between the Satellite-Derived Cloud Index and the other table entries. This is crucial to the study, because it makes it possible to assign a probable seeding effect for each target as a function of the satellite-measured cloud structure on each day for which measurements are available.

Table 6

**Apparent Effect of Seeding (Seeding Factor) vs. the Supercooled Rainwater Index and the Satellite Cloud Index
(Based on an overall seeding factor in Thailand of 1.43, which was obtained from multiple linear regression)**

Daily Coalescence Rating	Supercooled Rainwater Index	Seeding Factor (S/NS)	Satellite-Derived Cloud Index
No Coalescence	0%	1.70	1
		1.71	1.5
Light Coalescence	0 to 9%	1.72	2
		2.23	2.5
Moderate Coalescence	10 to 49%	2.74	3
		1.96	3.5
Enhanced Coalescence	50 to 89%	1.18	4
		1.01	4.5
Strong Coalescence	$\geq 90\%$	0.85	5

By using the information in Table 6 the cloud classification values in Appendix B were converted to the hypothetical seeding effects by day and by target that will be used in Task 3. Upon examining the values in Appendix B it is obvious that there were many days for which it was impossible to make direct inferences of cloud microstructure due to a lack of useable AVHRR imagery or to a lack of clouds. It was necessary, therefore, to resort to extrapolation from days with observations in order to fill the gaps. Although this is not an optimal situation, it is still better than having no satellite inferences of cloud structure at all.

Those interested in the average hypothetical seeding effect by target and by season for only those days on which it was possible to make direct inferences of cloud microstructure are referred to the last column of Table 5. Although there is some variability between 1999 and 2000, there is an obvious trend, suggesting that the effect of cold-cloud seeding should increase

as one moves southeast through Texas. This is somewhat of a surprise since the hypothetical effect of seeding falls off rapidly under conditions of intense coalescence, which is climatologically more prevalent in the east and southeast portions of Texas. The only way this apparent contradiction can be explained is that the 1999 and 2000 seasons were drier than usual, having fewer days with intense coalescence.

11.0 RADAR ESTIMATION OF RAINFALL IN TEXAS

The potential alteration of rainfall by seeding, and the impact of the alterations on the water supplies of Texas is the focus of this study for the TWDB. Making this assessment requires the statewide measurement of convective rainfall, which is a major challenge. The point measurement of convective rainfall with rain gauges is an accepted standard, even though gauges are subject to errors due to wind and disturbance of the airflow by nearby obstacles. Even so, it would take hundreds of recording rain gauges to measure the rainfall accurately throughout Texas. The official climatological rain gauge network of Texas consists of 182 recording rain gauges, which is inadequate for the measurement of rainfall from convective clouds and cloud systems. Supplemental recording gauges are available in the state but they are too few and too intermittent to be of much value in measuring Texas convective rainfall.

Radar is an attractive alternative for the estimation of convective rainfall, because it provides the equivalent of a very dense gauge network. Radar estimation of rainfall is, however, a complex undertaking involving determination of the radar parameters, calibration of the system, anomalous propagation of the radar beam, concerns about beam filling and attenuation, and the development of equations relating radar reflectivity to rainfall rate, where radar reflectivity is proportional to the sixth power of the droplet diameters in the radar beam.

Some scientists have spent virtually their entire careers perfecting radar rainfall estimates, but even then the results are not always to their liking. That is why it is good practice to compare the radar rainfall estimates with those of rain gauges in small but dense arrays. Such reality checks are crucial to the credibility of the estimates.

The initial intention was to use the C-band project radars for rain estimation in this research effort, but this proved to be unfeasible. None of the projects operate their radars round-the-clock, meaning that some rainfalls are not measured, thereby making it impossible to reach the goals of this study. Further, the project radars also were found to suffer from other problems, including attenuation of the energy beam in heavy rain and ground clutter, which was sometimes interspersed with rain events, especially during their later stages. Because this "false rainfall" could not be removed, it was a source of potential error in estimating the rainfall to be compared with the rain gauges.

At this point it was obvious that a change in plan had to be made. If rainfall were to be estimated around-the-clock in Texas and spot-checked by comparison with rain gauges, it would have to be done with a different radar system. An obvious possibility was the use of NEXRAD radar systems that are distributed about the state. These are S-band radars, which do not attenuate appreciably in heavy rain, and they are operated continuously unless they are down for

maintenance. In addition, the NEXRAD radars have a clutter-removal algorithm that eliminates most of the false rainfall produced during periods of anomalous propagation.

Investigation of the availability of NEXRAD data revealed a source at NASA's Global Hydrology Resource Center (GHRC), which receives merged 15-min reflectivity data from WSI, Inc. for all of the NEXRAD sites in the United States. (WSI, Inc. obtains the data from the National Weather Service.) These data were secured subsequently for the period of interest. The plan was to generate radar rainfalls for all of Texas and for various sub-areas within the state, including the nine seeding targets and various hydrological areas. These products would then be available for completion of Task 3 and as input to Task 4.

It should be noted here that until recently WSI, Inc. prepared and distributed its own national radar-estimated rain map from the national network of NEXRAD radars. Upon our examination of this product for our period of interest, it was found to be seriously in error for reasons that are not clear at this writing. Enormous rainfalls, exceeding 30 inches per month, were noted consistently in many areas even though no such rainfalls were measured by rain gauges. The errors appeared to be factors of 4 to 5 too high relative to gauge measurements and are likely due to a systematic error in the rainfall calculations. Apparently no one had brought these errors to their attention, so they could take corrective action. Woodley called the GHRC, which distributes the WSI, Inc. rainfall product and told them of the problem and they expressed gratitude for having received this information. It is now of mainly academic interest, however, since WSI, Inc. no longer produces the integrated rainfalls.

For this and other reasons, the rainfalls needed for this study were derived from the 15-min reflectivity data. Although a major undertaking no serious problems were encountered along the way. The initial work on Task 3 involved a test run of the data. This was followed by gauge vs. radar comparisons in the gauged portion of the High Plains target. Daily rainfalls were summed to provide monthly and seasonal (April through September) rainfall estimates. The next step was an attempt to determine the probable accuracy of the radar rainfall estimates relative to rain gauge measurements. The results of this study, which are highly encouraging, are provided in Appendix C, which contains a reprint of a paper by Woodley et al. (2001), which was published in the Journal of Weather Modification.

12.0 TASK 3 METHODOLOGY AND RESULTS

12.1 The Texas Seeding Targets

Task 3 of the TWDB contract calls for estimation of the amount of additional rainfall to be expected in Texas from seeding under various weather regimes as a function of space and time. Rainfall was examined on a daily basis over the areas shown in Figures 6 through 9. **The period of "daily" rain estimation was tied deliberately to the convective cycle, beginning at 0700 CDT on the day of interest to 0659 CDT the next day.** The key to the numbered areas is provided in Table 7. Figure 6 contains the 10 Texas seeding targets (areas 4 to 12 + area 50). The Texas aquifers of interest are shown in Figures 7 and 8 (i.e., areas 1 to 3 +13 to 23 and areas 24 to 37) and the Texas drainage basins of interest are illustrated in Figure 9 (i.e., areas 38 to 49). All of Texas is the 51st area.

Table 7. Area Key for the Radar Rainfall Analyses

Area #	Area Size (km ²)	Description of Area
1	319	Hondo Creek
2	505	Guadalupe Creek
3	845	San Antonio
4	33,788	Panhandle Target
5	19,556	North Plains Target
6	44,755	High Plains Target
7	11,714	CRMWD Target
8	23,977	West Texas Target
9	14,675	Texas Border Target
10	22,658	Edwards Aquifer Target
11	18,824	Southwest Texas Target
12	17,704	South Texas Target
13	1,745	Alluvium and Bolson Aquifers: Hueco-Mesilla Bolson Segment
14	2,391	Carrizo-Wilcox Aquifer: Rio Grande to Nueces River Segment
15	608	Carrizo-Wilcox Aquifer: Nueces to Guadalupe River Segment
16	1,024	Carrizo-Wilcox Aquifer: Guadalupe River to Colorado River
17	2,830	Carrizo-Wilcox Aquifer: Colorado River to Brazos River
18	3,919	Carrizo-Wilcox Aquifer: Brazos River to Trinity River
19	8,385	Carrizo-Wilcox Aquifer: Trinity River to Sulfur River
20	4,081	Carrizo-Wilcox Aquifer: Eastern Segment
21	6,191	Edwards (Balcones Fault Zone) Aquifer: San Antonio Segment
22	498	Edwards (Balcones Fault Zone) Aquifer: Barton Spring Segment
23	1,120	Edwards (Balcones Fault Zone) Aquifer: Northern Segment
24	10,371	Edwards-Trinity Aquifer: Central Segment
25	5,496	Edwards-Trinity Aquifer: Stockton Plateau Segment
26	2,363	Edwards-Trinity Aquifer: Trans-Pecos Segment
27	15,959	Gulf Coast Aquifer: Rio Grande to Nueces River Segment
28	20,707	Gulf Coast Aquifer: Nueces River to Brazos River Segment
29	16,547	Gulf Coast Aquifer: Brazos River to Sabine River Segment
30	14,032	Ogallala Aquifer: Northwest Segment
31	14,149	Ogallala Aquifer: Northeast Segment
32	15,289	Ogallala Aquifer: Central Segment
33	22,861	Ogallala Aquifer: Southern Segment
34	2,693	Trinity Aquifer: Lower Glen Rose Segment
35	1,762	Trinity Aquifer: South Central Segment
36	4,503	Trinity Aquifer North Central Segment
37	2,583	Trinity Aquifer: Northern Segment
38	11,985	Brazos River Drainage Basin: Lower Basin
39	18,835	Brazos River Drainage Basin: Middle Basin
40	14,925	Brazos River Drainage Basin: Upper Basin
41	4,259	Colorado River Drainage Basin: Lower Basin

42	20,961	Colorado River Drainage Basin: Middle Basin
43	46,551	Colorado River Drainage Basin: Upper Basin
44	8,509	Guadalupe River Drainage Basin: Lower Basin
45	4,297	Guadalupe River Drainage Basin: Upper Basin
46	19,319	Nueces River Drainage Basin: Lower Basin
47	3,102	Nueces River Drainage Basin: Upper Basin
48	11,686	Trinity River Drainage Basin: Lower Basin
49	17,773	Trinity River Drainage Basin: Upper Basin
50	20,590	Abilene Target
51	1,394,926	All Texas

Initial estimates of the hypothetical effect of seeding on each day for each seeding target were obtained by taking the product of the daily radar-estimated rainfall and the appropriate seeding factor. The former was obtained by integrating the 15-min NEXRAD base-scan reflectivity data. The latter was obtained by converting the satellite cloud classifications listed in Appendix B for each day to a seeding factor in the manner described above. As mentioned earlier, it was necessary to extrapolate the cloud classification values and seeding effects to days without direct measurements.

Once the daily estimates of seeded and non-seeded rainfalls were available, they were summed to obtain the "seeded" (S) and non-seeded (NS) rain volumes by month and for the entire 1999 and 2000 seasons. Results, including the differences (S-NS) and ratios (S/NS) of S and NS rainfalls, are given in Tables 8 and 9. The daily calculations from which the monthly and seasonal values were derived are available on computer disk. The rain volume units are in 10^3 m^3 . Division by $1.22 \times 10^3 \text{ m}^3$ converts the listed values to acre-feet, which is the unit desired by the TWDB. Conversion to acre-feet units is made in later tables. If rain depths in mm are desired for any time period and for any area, divide the listed rain volume by the appropriate area size (in km^2) listed in Table 7. Further division by 25.4 converts the values to units of inches.

There is an enormous amount of information in Tables 8 and 9. What is somewhat surprising is the large size of the monthly and seasonal hypothetical seeding effects, even though the input hypothetical seeding effects obtained in Thailand were adjusted downward by a factor 1.34 using linear regression to account for natural rainfall biases. Note that the apparent seeding effects (i.e., S/NS ratios) shown in Tables 8 and 9 are still > 2 in several instances. Upon examining the values in Table 6, however, one notes that several of the seeding factors to be applied as a function of cloud structure even after adjustment are still > 2.0 . Thus, the reason the Texas results are so large becomes clear. Unlike Thailand, the class of clouds giving small seeding effects (i.e., cloud classes 4 and 5) did not occur very frequently in Texas during 1999 and 2000. Consequently, a preponderance of large seeding ratios was applied to the radar-estimated rainfall data, resulting in large apparent seeding effects.

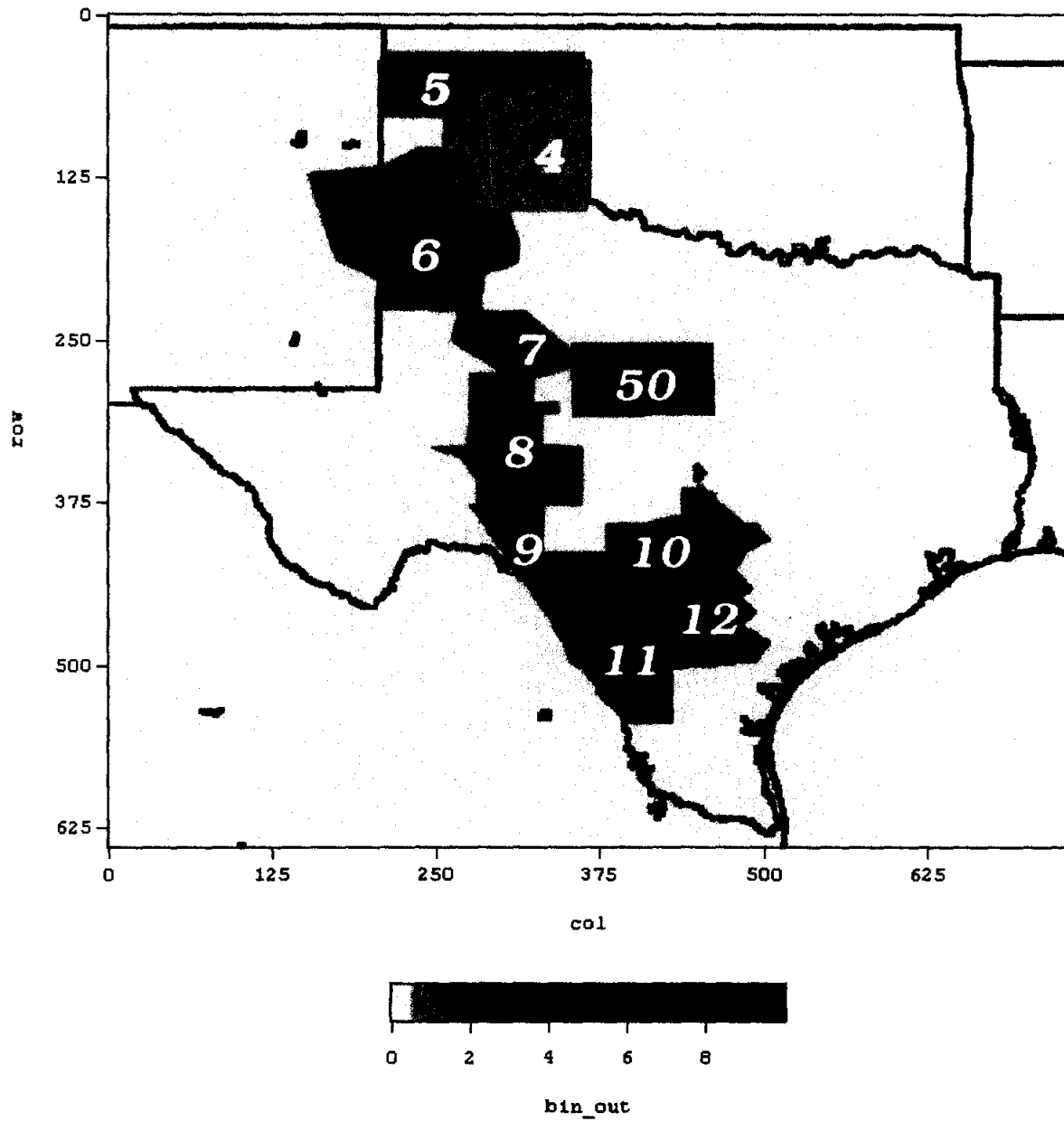

Figure 6. Map of the 10 operational seeding targets in Texas as of the summer of 2001. The key to the numbered areas is provided in Table 7.

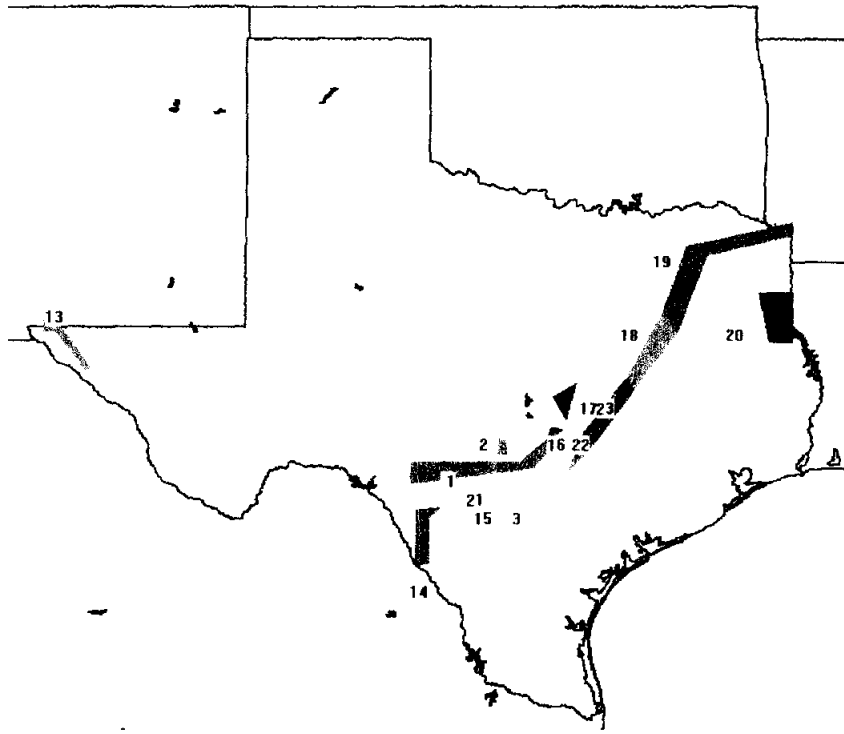

Figure 7. Map of 14 Texas aquifers for which radar rainfall estimates were made. The key to the numbered areas is provided in Table 7.

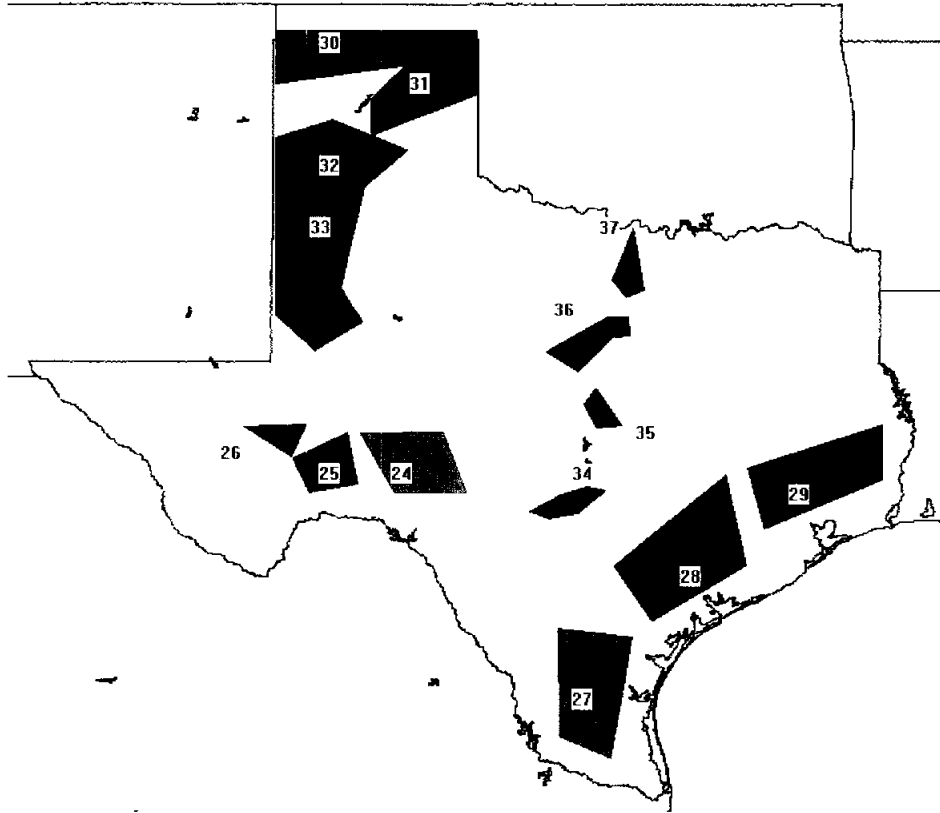

Figure 8. Map of 14 additional Texas aquifers for which radar rainfall estimates were made. The key to the numbered areas is provided in Table 7.

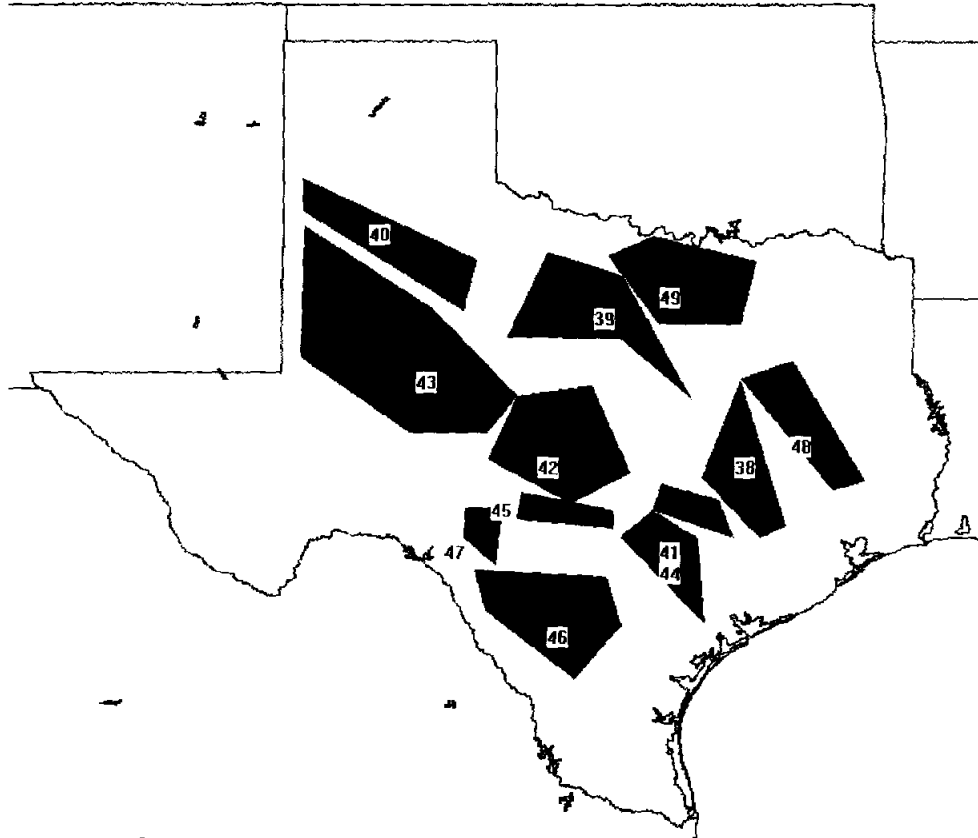

Figure 9. Map of 12 Texas drainage basins for which radar rainfall estimates were made. The key to the numbered areas is provided in Table 7.

Table 7 Monthly Target Rain Volumes in m³ x 10³

1999 Calculations										
Month	A4	A5	A6	A6S	S-NS	S/NS	A7	A7S	S-NS	S/NS
April	2,025,252	929,012	2,366,985	4,053,219	1,686,233	1.71	532,590	907,416	374,826	1.70
May	2,131,876	591,794	3,211,146	6,492,956	3,281,810	2.02	879,609	1,570,187	690,578	1.79
June	2,189,293	1,323,030	4,389,528	7,019,102	2,629,573	1.60	1,364,918	2,329,039	964,121	1.71
July	1,047,537	434,904	1,575,107	3,064,171	1,489,064	1.95	309,557	612,400	302,843	1.98
August	257,448	224,365	1,182,945	2,834,554	1,651,609	2.40	119,160	240,849	121,689	2.02
September	1,305,529	439,812	2,334,728	4,542,466	2,207,738	1.95	487,368	978,162	490,794	2.01
Sum	8,956,935	3,942,916	15,060,440	28,006,467	12,946,027	1.86	3,693,203	6,638,053	2,944,850	1.80

Month	A8	A8S	S-NS	S/NS	A9	A9S	S-NS	S/NS
April	799,346	1,370,235	570,889	1.71	354,892	608,598	253,706	1.71
May	1,445,135	3,040,181	1,595,046	2.10	447,131	868,042	420,911	1.94
June	1,128,525	2,127,048	998,523	1.88	730,121	1,106,614	376,493	1.52
July	282,095	508,667	226,573	1.80	297,937	524,123	226,186	1.76
August	165,920	284,281	118,361	1.71	210,541	362,096	151,555	1.72
September	382,179	764,754	382,575	2.00	163,983	346,210	182,227	2.11
Sum	4,203,200	8,095,167	3,891,967	1.93	2,204,605	3,815,683	1,611,078	1.73

Month	A10	A10S	S-NS	S/NS	A11	A11S	S-NS	S/NS	A4	A5	A6	A7	A8	A9	A10	A11	A12
April	708,840	1,459,990	751,150	2.06	236,532	493,353	256,821	2.09	Panhandle	North Plains	High Plains	CRMWD	West Texas	Texas Border	Edwards	Southwest Texas	South Texas
May	1,263,999	2,594,091	1,330,093	2.05	949,639	1,875,651	926,012	1.98									
June	1,527,811	3,550,494	2,022,683	2.32	995,197	1,984,517	989,320	1.99									
July	945,452	2,001,320	1,055,868	2.12	490,515	639,061	148,545	1.30									
August	264,475	456,049	191,574	1.72	775,369	1,990,527	1,215,158	2.57									
September	281,834	441,750	159,916	1.57	193,457	291,673	98,215	1.51									
Sum	4,992,411	10,503,695	5,511,284	2.10	3,640,710	7,274,782	3,634,072	2.00									

Month	A12	A12S	S-NS	S/NS
April	514,579	1,085,080	570,501	2.11
May	866,313	1,814,194	947882	2.09
June	1,366,113	2,451,539	1085426	1.79
July	738,978	1,194,519	455541	1.62
August	744,988	1,826,125	1081137	2.45
September	328,675	459,232	130557	1.40
Sum	4,559,646	8,830,689	4271043	1.94

Divide volumetric values by 1.22 to obtain acre-feet.

rvol99c sheet 4 revised

Table 9 Monthly Target Rain Volumes in m³ x 10³

2000 Calculations

Month	A4	A4S	S-NS	S/NS	A5	A5S	S-NS	S/NS
April	1,452,807	2,477,930	1,025,124	1.71	349,589	597,102	247,513	1.71
May	1,272,869	2,182,684	909,815	1.71	474,308	822,797	348,489	1.73
June	4,656,028	8,951,881	4,295,853	1.92	2,212,548	4,398,908	2,186,359	1.99
July	1,325,761	2,473,772	1,148,011	1.87	962,193	1,721,351	759,158	1.79
August	238,513	462,828	224,315	1.94	349,802	627,145	277,344	1.79
September	51,468	87,496	36,028	1.70	123,789	149,611	25,823	1.21
Sum	8,997,446	16,636,592	7,639,146	1.85	4,472,229	8,316,915	3,844,685	1.86

Month	A6	A6S	S-NS	S/NS	A7	A7S	S-NS	S/NS
April	620,724	1,055,815	435,091	1.70	61,841	105,129	43,288	1.70
May	769,915	1,376,925	607,010	1.79	426,365	844,289	417,923	1.98
June	5,462,029	12,983,321	7,521,292	2.38	956,346	2,134,370	1,178,024	2.23
July	2,386,054	4,546,086	2,160,032	1.91	356,568	632,580	276,012	1.77
August	349,802	983,041	633,239	2.81	42,421	74,297	31,877	1.75
September	75,751	129,520	53,769	1.71	78,568	159,582	81,014	2.03
Sum	9,664,273	21,074,707	11,410,434	2.18	1,922,108	3,950,247	2,028,138	2.06

Month	A8	A8S	S-NS	S/NS	A9	A9S	S-NS	S/NS
April	773,245	1,318,289	545,044	1.70	355,596	609,380	253,784	1.71
May	548,196	1,123,703	575,506	2.05	249,898	491,456	241,558	1.97
June	1,770,889	3,120,912	1,350,023	1.76	634,417	1,174,326	539,909	1.85
July	318,861	508,025	189,164	1.59	144,724	285,131	140,406	1.97
August	20,313	34,938	14,625	1.72	51,238	125,719	74,481	2.45
September	478,883	1,054,384	575,501	2.20	361,038	617,361	256,323	1.71
Sum	3,910,387	7,160,251	3,249,863	1.83	1,796,911	3,303,372	1,506,461	1.84

Month	A10	A10S	S-NS	S/NS	A11	A11S	S-NS	S/NS
April	651,212	1,372,870	721,658	2.11	163,178	380,460	217,282	2.33
May	1,291,959	2,411,086	1,119,126	1.87	616,570	1,057,140	440,570	1.71
June	1,460,572	2,339,299	878,727	1.60	838,007	1,417,319	579,312	1.69
July	374,398	827,639	453,241	2.21	182,998	469,892	286,894	2.57
August	170,800	353,054	182,254	2.07	161,507	327,231	165,724	2.03
September	801,903	1,216,342	414,439	1.52	323,929	494,272	170,343	1.53
Sum	4,750,844	8,520,289	3,769,445	1.79	2,286,190	4,146,314	1,860,124	1.81

Month	A12	A12S	S-NS	S/NS	A4	Panhandle
April	356,922	932,306	575,384	2.61	A5	North Plains
May	1,024,195	1,827,945	803,749	1.78	A6	High Plains
June	1,273,332	2,674,813	1,401,482	2.10	A7	CRMWD
July	190,576	464,555	273,979	2.44	A8	West Texas
August	246,681	464,248	217,567	1.88	A9	Texas Border
September	378,726	592,503	213,777	1.56	A10	Edwards
Sum	3,470,432	6,956,370	3,485,938	2.00	A11	Southwest Texas
					A12	South Texas

Strictly speaking, however, the results in Tables 8 and 9 are applicable only to areas of around 2,000 km² (about 800 mi²), which was the size of the floating target in Thailand, since the hypothetical effect of seeding, expressed as a percentage of the "natural" rainfall, depends on scale. Based on past Texas and Thai experimentation, the seeding factor on the scale of individual clouds having base areas averaging 75 km² (29 mi²) is on the order of 1.75 (i.e., +75%). When dealing with the Texas and Thai experimental units covering 1,964 km² (758 mi²), the seeding factor drops to about 1.43 (i.e., +43%). The apparent effect of seeding in the FACE-1 (Florida) seeding target covering 13,000 km² (5,019 mi²) was 1.23 (i.e., +23%). Most of the Texas seeding targets are larger than the FACE target, suggesting that the overall effect of seeding in areas of this size, expressed as a percentage above the natural rainfall, should be somewhat smaller still, probably on the order of +10%. **Therefore, upon considering the size of the Texas targets, it is assumed that the high, middle and low probable seeding effects for the Texas seeding targets are one-half, one-quarter and one-eighth of the values listed in Tables 8 and 9.** This is quantified in subsequent tables.

Another surprise in Tables 8 and 9 is the lack of an obvious trend in the apparent seeding effects. No single target or region in Texas has the largest seeding effects. They are rather large everywhere and vary from month-to-month and from area-to-area. This variability may be real, or it could be due to the lack of satellite data from which cloud classifications and probable seeding effects could be derived.

In considering these results, it should be remembered that radar does not provide an absolute measure of the rainfall, so errors should be considered in estimating the rainfall and the probable increments due to seeding. As it turns out, however, the errors for radar estimates of monthly and seasonal precipitation are much smaller than the probable uncertainties associated with the imposition of seeding effects (See Appendix C). At worst the radar estimates of rainfall for this study are probably in error by no more than $\pm 20\%$. The same can hardly be said about the uncertainties with respect to the expected effects of seeding.

12.2 The Areas of Hydrologic Interest

The next step is the extension of these plans and results to the 40 areas of hydrologic interest shown in Figures 7-9. The first step is obviously estimation of the daily, monthly and seasonal rainfalls for these areas. A listing of the radar-estimated monthly and seasonal rainfalls in 1999 and 2000 for these hydrologic areas is provided in Tables 10 and 11, respectively.

The challenge is the superposition of seeding effects on the hydrologic areas. The initial intention was to attempt an extrapolation of the target results to the hydrologic areas. Upon examining the data, however, this seems neither possible nor wise, because the results do not show a systematic trend through Texas. In adopting a conservative approach, it was decided that the seeding factors listed in Table 12 below would be applied to the hydrologic areas as a function of their size. They are consistent with the results of experimentation in Florida and Texas having target sizes of 13,000 km² and 1,964 km² for which the apparent seeding effects were 1.23 and 1.45, respectively.

Table 10 Monthly Rain Volumes in m³ x 10³ for Various Areas of Hydrologic Interest in 1999

Month	Area 1	Area 2	Area 3	Area 14	Area 15	Area 16	Area 17	Area 18	Area 19	Area 20	Area 21	Area 22	Area 23
April	14,825	11,993	25,978	34,000	18,038	17,510	54,507	102,110	221,909	97,872	250,869	9,885	35,517
May	15,225	25,813	44,183	82,917	29,055	106,244	295,719	404,055	1,294,577	642,545	207,255	39,793	181,787
June	19,503	28,155	94,404	118,962	44,258	53,777	132,374	227,363	473,121	329,285	391,650	27,065	61,244
July	18,891	15,142	47,035	52,422	20,158	43,114	130,664	135,356	196,295	197,386	256,377	25,372	85,871
August	3,168	2,374	21,790	72,783	10,150	5,267	14,720	36,004	58,426	27,743	57,867	1,115	2,180
September	5,206	4,251	7,772	10,575	8,552	7,482	31,328	123,025	362,326	198,844	80,875	3,763	7,619
Sum	76,819	87,728	241,162	371,658	130,211	233,395	659,313	1,027,913	2,606,654	1,493,676	1,244,894	106,992	374,218

Month	Area 24	Area 25	Area 26	Area 27	Area 28	Area 29	Area 30	Area 31	Area 32	Area 33	Area 34	Area 35	Area 36
April	361,951	99,852	10,655	98,252	265,121	311,494	615,180	806,427	1,047,660	1,288,121	64,052	53,321	178,464
May	480,834	420,618	109,120	932,115	2,329,266	1,901,716	352,653	651,271	961,583	1,495,109	127,453	204,358	448,202
June	381,868	236,776	132,947	1,059,679	2,123,397	1,566,329	906,355	1,100,156	1,377,314	2,462,130	140,537	84,627	430,294
July	168,462	102,006	60,915	894,618	1,201,117	1,140,715	287,978	412,894	737,748	590,987	118,656	51,486	88,820
August	66,198	7,279	4,471	1,054,923	357,475	289,815	192,942	74,285	278,822	667,933	20,848	8,476	34,934
September	90,356	38,296	33,888	839,346	567,663	537,024	275,346	554,944	898,667	992,141	29,229	32,326	100,533
Sum	1,549,670	904,827	351,996	4,878,933	6,844,039	5,747,094	2,630,455	3,599,978	5,301,794	7,496,421	500,776	434,594	1,281,247

Month	Area 37	Area 38	Area 39	Area 40	Area 41	Area 42	Area 43	Area 44	Area 45	Area 46	Area 47	Area 48	Area 49
April	121,163	259,733	828,041	1,167,720	66,622	680,294	1,815,009	128,021	144,382	415,074	174,823	239,746	601,654
May	454,578	1,263,878	2,086,522	1,745,364	423,699	2,398,811	3,069,762	958,997	251,607	837,109	101,439	1,215,846	3,077,178
June	159,258	727,496	1,845,596	1,898,973	254,759	863,991	3,946,028	807,170	239,005	1,336,673	137,715	862,949	960,236
July	36,758	554,373	284,846	322,953	224,243	622,164	888,341	370,280	141,524	658,826	85,289	607,914	356,172
August	32,108	126,123	250,721	372,248	14,713	141,764	612,126	141,041	52,303	756,660	24,163	126,722	170,050
September	115,703	190,707	720,147	582,913	42,061	169,824	1,455,327	174,914	52,303	201,816	34,764	395,265	908,266
Sum	919,568	3,122,310	6,015,873	6,090,171	1,026,097	4,876,848	11,786,592	2,580,423	881,124	4,206,158	558,192	3,448,442	6,073,556

Month	Area 13	Area 50	Area 51
April	5,157	878,094	36,355,342
May	12,303	1,896,570	83,213,062
June	27,324	1,736,237	78,441,929
July	68,516	398,062	42,446,729
August	53,422	379,880	43,484,152
September	17,190	402,602	42,080,108
Sum	178,755	5,691,445	326,021,323

Revised rvol99c sheet 5

Table 11 Monthly Rain Volumes in m³ x 10³ for Various Areas of Hydrologic Interest in 2000

Month	Area 1	Area 2	Area 3	Area 14	Area 15	Area 16	Area 17	Area 18	Area 19	Area 20	Area 21	Area 22	Area 23
April	11,000	11,398	24,422	12,995	14,895	29,197	91,869	170,832	490,988	252,142	1,270,455	16,103	44,372
May	16,845	34,094	53,196	45,008	27,338	71,841	258,897	464,327	891,384	518,506	287,782	19,007	90,840
June	14,543	27,193	67,995	80,861	35,384	57,939	189,853	388,081	1,330,046	318,304	391,280	43,301	128,099
July	12,387	8,064	13,173	13,781	5,845	7,969	59,406	7,733	51,852	48,820	152,212	6,984	24,549
August	2,126	6,399	11,187	4,369	6,252	13,071	29,697	35,902	36,557	56,275	37,568	2,561	9,313
September	9,384	27,085	45,202	33,444	16,071	26,517	132,021	165,310	211,118	117,330	217,515	10,275	31,382
Sum	66,286	114,233	215,174	190,457	105,786	206,534	761,742	1,232,185	3,011,945	1,311,377	2,356,812	98,231	328,554

Month	Area 24	Area 25	Area 26	Area 27	Area 28	Area 29	Area 30	Area 31	Area 32	Area 33	Area 34	Area 35	Area 36
April	458,069	58,878	13,212	284,837	264,386	292,451	240,137	522,106	214,556	248,439	66,720	84,509	241,165
May	307,926	60,314	22,201	1,716,927	1,874,944	1,601,617	284,445	622,139	538,028	392,015	136,669	142,115	220,847
June	762,929	355,232	162,458	711,439	1,554,928	1,153,430	1,545,142	2,071,774	2,012,468	2,639,526	136,789	159,325	461,703
July	110,606	61,504	25,996	178,514	643,986	548,091	639,973	614,526	713,892	760,345	50,354	12,851	29,955
August	13,195	22,069	20,543	384,068	556,579	601,044	268,949	118,448	136,569	358,846	22,732	8,733	262
September	312,252	128,968	2,503	347,848	550,396	934,115	98,895	27,110	27,359	26,489	100,552	51,763	57,018
Sum	1,964,977	686,965	246,913	3,623,633	5,445,220	5,130,748	3,077,541	3,976,104	3,642,872	4,425,660	513,816	459,296	1,010,950

Month	Area 37	Area 38	Area 39	Area 40	Area 41	Area 42	Area 43	Area 44	Area 45	Area 46	Area 47	Area 48	Area 49
April	296,645	315,333	1,474,988	481,991	122,157	851,045	586,441	179,423	114,124	279,203	85,956	306,016	1,515,357
May	183,138	1,172,238	1,224,808	508,407	278,852	1,196,768	1,431,717	759,690	305,201	761,434	96,862	1,167,510	1,361,935
June	268,706	863,050	1,759,692	1,520,690	288,922	1,523,593	3,919,510	761,826	77,452	1,034,018	174,174	1,013,901	1,823,760
July	50,880	167,031	332,091	593,675	79,492	400,274	1,064,020	144,201	93,264	167,741	71,065	210,999	249,999
August	34	195,668	6,968	117,752	63,234	49,863	308,237	146,291	34,604	161,333	17,372	206,977	1,183
September	44,689	534,342	187,685	34,611	104,629	872,117	350,974	252,533	201,080	411,520	112,898	570,943	280,400
Sum	844,092	3,247,663	4,986,232	3,257,125	937,286	4,893,660	7,660,900	2,243,965	825,724	2,815,249	558,328	3,476,347	5,232,634

Month	Area 13	Area 50	Area 51
April	343	1,022,896	31,609,754
May	1,310	961,054	51,105,638
June	51,703	1,764,181	84,425,178
July	38,885	222,669	34,447,598
August	24,214	2,254	16,017,170
September	2,141	389,744	20,776,091
Sum	118,595	4,362,798	238,381,429

rvol00b sheet 3
revised

After following the procedures specified above, the rain volumes by month and by season after hypothetical seeding in each seeding target are provided in Tables 13 and 14 and in each hydrologic area in Tables 15 and 16. Note that Area 13 in both tables is out of numerical order, appearing after 49. There are five columns for each area. The first is the radar measured rainfall in 10^3 m^3 , where $10^3 \text{ m}^3 = 1$ kiloton. The second provides the values converted to acre-feet, and the third, fourth and fifth columns give the high, middle and low total rain volumes in acre-feet after hypothetical seeding, respectively. The value at the top of the first column of each area set, just below the title in Tables 15 and 16 is the size of that area in km^2 . It can be used in the calculation of the seasonal rain depth by dividing the seasonal rain volume by the area. The same process can be used to calculate the rain depth for any period for which a rain volume has been calculated. As an example, the radar-estimated seasonal rain depths for the entire State of Texas were 234 and 171 mm in 1999 and 2000, respectively. Thus, it was drier statewide during the summer season in 2000 than in 1999 by a factor of 1.32, according to the radar estimates.

Table 12

Range of Seeding Factors (SF) to be Applied to the Hydrologic Areas as a Function of Area Size

Area Size in km^2 (mi^2)	Maximum SF	Most Probable SF	Minimum SF
< 1,000 (387)	---	1.90	1.45
1,000 (387) to 10,000 (3,870)	1.90	1.45	1.22
10,000 (3,870) to 50,000 (19,350)	1.45	1.22	1.11
> 50,000 (19,350)	1.22	1.11	1.06

12.3 Estimation of Seeding Effects as a Function of Rain Amount and Time

The TWDB contract calls for estimation of the effects of seeding under conditions of above normal, near normal and below normal rainfall. Unfortunately, the rainfall in Texas in April to September in 1999 and 2000 was below normal. It should still be possible, however, to infer the effect of seeding in Texas on days in these periods with heavy, moderate and light natural rainfall.

This exercise depends in part on the well-known finding with respect to convective rainfall that typically 10% of the days with measurable rainfall in any time period account for 50% of the rainfall produced in that time period. For the purposes of this study, these will be called heavy rain days. Elaborating further, 50% of the days with measurable rain produce 90% of the rainfall measured in that time period. Thus, the 40% second wettest days produce 40% of the rainfall. These will be called moderate rain days. Finally, the remaining 50% of the days with measurable convective rainfall produce at most only 10% of the total rainfall in the period of interest. These will be called light rain days.

Table 13 Range of Hypothetical Seeding Effects for the Texas Seeding Targets in 1999

(For each area the values in the first column are in m³ x 10³. All other values are in acre-ft

Month	A4NS	A4NS(a.f.)	A4Shigh	A4Smiddle	A4Slow	A5NS	A5NS(a.f.)	A5Shigh	A5Smiddle	A5Slow
April	2,025,252	1,660,043	2,407,062	2,025,252	1,842,648	929,012	761,485	1,104,154	929,012	845,249
May	2,131,876	1,747,439	2,533,787	2,131,876	1,939,658	591,794	485,077	703,361	591,794	538,435
June	2,189,293	1,794,502	2,602,029	2,189,293	1,991,898	1,323,030	1,084,450	1,572,453	1,323,030	1,203,740
July	1,047,537	858,637	1,245,023	1,047,537	953,087	434,904	356,478	516,894	434,904	395,691
August	257,448	211,023	305,983	257,448	234,236	224,365	183,906	266,663	224,365	204,135
September	1,305,529	1,070,106	1,551,653	1,305,529	1,187,817	439,812	360,502	522,727	439,812	400,157
Sum	8,956,935	7,341,750	10,645,537	8,956,935	8,149,342	3,942,916	3,231,898	4,686,253	3,942,916	3,587,407
	0.2650888					0.2010204				
Month	A6NS	A6NS(a.f.)	A6Shigh	A6Smiddle	A6Slow	A7NS	A7NS(a.f.)	A7Shigh	A7Smiddle	A7Slow
April	2,366,985	1,940,152	2,619,205	2,289,379	2114765.7	532,590	436,549	589,342	512,945	475,839
May	3,211,146	2,632,087	3,974,451	3,290,108	2192371.8	879,609	720,991	1,005,783	865,189	793,090
June	4,389,528	3,597,974	4,677,366	4,137,670	3849832.3	1,364,918	1,118,785	1,515,954	1,320,167	1,219,476
July	1,575,107	1,291,071	1,897,875	1,588,018	1446000	309,557	253,736	378,066	317,169	286,721
August	1,182,945	969,627	1,648,366	1,308,996	1144159.7	119,160	97,672	147,485	122,090	110,370
September	2,334,728	1,913,712	2,813,156	2,353,865	2,124,220	487,368	399,482	601,221	499,353	451,415
Sum	15,060,440	12,344,623	17,630,419	14,968,037	12,871,349	3,693,203	3,027,216	4,237,850	3,636,914	3,336,911
	0.3348214					0.316239				
Month	A8NS	A8NS(a.f.)	A8Shigh	A8Smiddle	A8Slow	A9NS	A9NS(A.f.)	A9Shigh	A9Smiddle	A9Slow
April	799,346	655,201	887,798	773,138	714,169	354,892	290,895	394,162	343,256	317,075
May	1,445,135	1,184,537	1,836,033	1,510,285	1,350,372	447,131	366,501	538,756	454,461	410,481
June	1,128,525	925,021	1,332,030	1,128,525	1,026,773	730,121	598,460	754,060	676,260	640,352
July	282,095	231,225	323,715	277,470	252035.56	297,937	244,211	337,011	290,611	268,632
August	165,920	136,000	184,280	160,480	153679.62	210,541	172,575	234,701	203,638	188,106
September	382,179	313,262	469,892	391,577	353985.64	163,983	134,412	208,339	220,032	153,230
Sum	4,203,200	3,445,246	5,033,748	4,241,475	3,851,016	2,204,605	1,807,053	2,467,029	2,188,258	1,977,876
	0.1666667					0.1496599				

Table 13 (cont.) Range of Hypothetical Seeding Effects for the Texas Seeding Targets in 1999

Month	A10NS	A10NS(a.f.)	A10Shigh	A10Smiddle	A10Slow	A11NS	A11NS(a.f.)	A11Shigh	A11Smiddle	A11Slow
April	708,840	581,017	888,955	737,891	662,359	236,532	193,878	298,573	246,226	220,052
May	1,263,999	1,036,065	1,579,999	1,305,441	1,170,753	949,639	778,393	1,159,805	972,991	1,165,573
June	1,527,811	1,252,304	2,078,824	1,665,564	1,465,196	995,197	815,735	1,223,603	1,019,669	1,408,842
July	945,452	774,961	1,208,939	991,950	883,455	490,515	402,062	462,371	432,216	805,959
August	264,475	216,783	294,825	255,804	236,293	775,369	635,549	1,124,921	880,235	257,971
September	281,834	231,012	295,695	263,353	247,182	193,457	158,572	245,786	202,179	263,353
Sum	4,992,411	4,092,140	6,347,236	5,220,003	4,665,238	3,640,710	2,984,189	4,515,059	3,753,516	4,121,750
	0.2212389					0.193617				

Month	A12	A12NS(a.f.)	A12Shigh	A12Smiddle	A12Slow
April	514,579	421,786	643,224	533,559	476,618
May	866,313	710,092	1,075,790	894,716	802,404
June	1,366,113	1,119,765	1,601,264	1,360,514	1,242,939
July	738,978	605,720	802,579	702,635	654,177
August	744,988	610,646	1,047,258	830,479	720,562
September	328,675	269,406	362,351	315,205	292,305
Sum	4,559,646	3,737,415	5,532,465	4,637,108	4,189,006
	0.2576271				

rvol99c, s10, p2 revised

Table 14 Range of Hypothetical Seeding Effects for the Texas Seeding Targets in 2000

Month	A4NS	A4NS(a.f.)	A4Shigh	A4Smiddle	A4Slow	A5NS	A5NS(a.f.)	A5Shigh	A5Smiddle	A5Slow
April	1,452,807	1,190,825	1,613,568	1,405,174	1,297,999	349,589	286,549	388,274	338,127	312,338
May	1,272,869	1,043,335	1,413,719	1,231,135	1,137,235	474,308	388,777	530,681	458,757	423,767
June	4,656,028	3,816,417	5,571,968	4,694,192	4,255,304	2,212,548	1,813,564	2,711,279	2,266,955	2,040,260
July	1,325,761	1,086,689	1,559,399	1,336,628	1,211,659	962,193	788,683	1,100,212	946,419	867,551
August	238,513	195,503	287,389	241,446	218,963	349,802	286,723	399,978	344,067	315,395
September	51,468	42,187	56,953	49,781	45,984	123,789	101,466	112,120	106,540	104,003
Sum	8,997,446	7,374,956	10,502,996	8,958,356	8,167,145	4,472,229	3,665,762	5,242,544	4,460,866	4,063,314
	0.266351					0.228528				
Month	A6NS	A6NS(a.f.)	A6Shigh	A6Smiddle	A6Slow	A7NS	A7NS(a.f.)	A7Shigh	A7Smiddle	A7Slow
April	620,724	508,790	686,866	600,372	554,581	61,841	50,689	68,430	59,560	54,998
May	769,915	631,078	880,354	757,293	694,186	426,365	349,480	520,725	435,102	391,417
June	5,462,029	4,477,073	7,566,253	6,021,663	5,238,175	956,346	783,890	1,265,983	1,026,896	905,393
July	2,386,054	1,955,782	2,855,441	2,405,611	2,180,697	356,568	292,269	404,792	347,800	320,034
August	349,802	286,723	544,773	415,748	351,235	42,421	34,771	46,767	40,682	37,727
September	75,751	62,091	84,133	73,267	67,679	78,568	64,400	97,565	81,143	72,772
Sum	9,664,273	7,921,535	12,617,820	10,273,954	9,086,552	1,922,108	1,575,499	2,404,263	1,991,184	1,782,341
	0.215818					0.163962				
Month	A8NS	A8NS(a.f.)	A8Shigh	A8Smiddle	A8Slow	A9NS	A9NS(A.f.)	A9Shigh	A9Smiddle	A9Slow
April	773,245	633,807	855,640	744,724	687,681	355,596	291472.5	394,945	343,938	317,705
May	548,196	449,341	685,245	566,170	507,756	249,898	204834.1	304,179	253,994	229,414
June	1,770,889	1,451,549	2,003,137	1,727,343	1,589,446	634,417	520013.7	741,020	629,217	574,615
July	318,861	261,362	338,463	300,566	280,964	144,724	118626.4	176,160	147,097	132,862
August	20,313	16,650	22,644	19,647	18,148	51,238	41998.48	72,447	57,118	49,558
September	478,883	392,527	628,043	510,285	451,406	361,038	295932.5	400,989	349,200	322,566
Sum	3,910,387	3,205,236	4,533,173	3,868,734	3,535,400	1,796,911	1472878	2,089,740	1,780,564	1,626,721
	0.163053					0.122699				
Month	A10NS	A10NS(a.f.)	A10Shigh	A10Smiddle	A10Slow	A11NS	A11NS(a.f.)	A11Shigh	A11Smiddle	A11Slow
April	651,212	533,780	830,028	683,239	608,509	163,178	133,752	222,697	177,890	155,821
May	1,291,959	1,058,983	1,519,641	1,286,664	1,170,176	616,570	505,386	750,498	626,678	566,032
June	1,460,572	1,197,190	1,556,347	1,376,769	1,286,979	838,007	686,891	978,820	831,138	759,015
July	374,398	306,883	492,548	398,948	352,916	182,998	149,998	222,748	185,998	167,998
August	170,800	140,000	214,900	177,100	158,200	161,507	132,383	228,361	180,041	156,212
September	801,903	657,298	828,195	742,746	700,022	323,929	265,516	359,774	313,309	289,412
Sum	4,750,844	3,894,135	5,441,659	4,665,467	4,276,803	2,286,190	1,873,926	2,762,897	2,315,055	2,094,490
	0.20962					0.121467				

Table 14 (cont.) Range of Hypothetical Seeding Effects for the Texas Seeding Targets in 2000

Month	A12	A12NS(a.f.)	A12Shigh	A12Smiddle	A12Slow	
April	356,922	292,559	482,722	387,640	339,368	
May	1,024,195	839,504	1,385,182	1,112,343	973,825	
June	1,273,332	1,043,714	1,722,129	1,382,922	1,210,709	
July	190,576	156,210	257,746	206,978	181,204	rvol00b, s7, p2 revised
August	246,681	202,198	333,626	267,912	234,549	
September	378,726	310,431	512,211	411,321	360,100	
Sum	3,470,432	2,844,616	4,693,617	3,769,117	3,299,755	
	0.196045					

Table 15 Range of Hypothetical Seeding Effects for the Hydrologic Areas in 1999

The units for the 1st column of each set are m**3 x 10**3; the units for all other columns are in acre-feet

Month	A1NS	A1NS(a.f.)	A1Shigh	A1Smiddle	A1Slow	A2NS	A2NS(a.f.)	A2Shigh	A2Smiddle	A2Slow
	319		1.90	1.90	1.45	505		1.90	1.90	1.45
April	14,825	12,152	23,089	23,089	17,620	11,993	9,830	18,678	18,678	14,254
May	15,225	12,480	23,711	23,711	18,096	25,813	21,158	40,200	40,200	30,679
June	19,503	15,986	30,373	30,373	23,180	28,155	23,078	43,848	43,848	33,463
July	18,891	15,484	29,420	29,420	22,452	15,142	12,412	23,582	23,582	17,997
August	3,168	2,597	4,934	4,934	3,765	2,374	1,946	3,698	3,698	2,822
September	5,206	4,267	8,108	8,108	6,188	4,251	3,484	6,620	6,620	5,052
Sum	76,819	62,966	119,636	119,636	91,301	87,728	71,908	136,626	136,626	104,267
Month	A3NS	A3NS(a.f.)	A3Shigh	A3Smiddle	A3Slow	A14NS	A14NSa.f.	A14Shigh	A14Smiddle	A14Shigh
	845.00		1.90	1.90	1.45	2,391		1.90	1.45	1.22
April	25,978	21,293	40,457	40,457	30,875	34,000	27,869	52,950	40,409	34,000
May	44,183	36,216	68,810	68,810	52,513	82,917	67,965	129,133	98,549	82,917
June	94,404	77,381	147,023	147,023	112,202	118,962	97,510	185,269	141,389	118,962
July	47,035	38,553	73,251	73,251	55,902	52,422	42,968	81,640	62,304	52,422
August	21,790	17,861	33,935	33,935	25,898	72,783	59,658	113,350	86,504	72,783
September	7,772	6,370	12,104	12,104	9,237	10,575	8,668	16,469	12,568	10,575
Sum	241,162	197,674	375,581	375,581	286,627	371,658	304,638	578,812	441,725	371,658
Month	A15NS	A15NSa.f.	A15Shigh	A15Smiddle	A15Slow	A16NS	A16NSa.f.	A16high	A16Smiddle	A16Slow
	608		1.90	1.45	1.22	1,023		1.90	1.90	1.45
April	18,038	14,785	28,092	21,438	18,038	17,510	14,353	27,270	27,270	20,812
May	29,055	23,816	45,250	34,533	29,055	106,244	87,085	165,462	165,462	126,274
June	44,258	36,277	68,926	52,602	44,258	53,777	44,080	83,751	83,751	63,916
July	20,158	16,523	31,393	23,958	20,158	43,114	35,339	67,145	67,145	51,242
August	10,150	8,320	15,808	12,064	10,150	5,267	4,318	8,203	8,203	6,260
September	8,552	7,010	13,319	10,164	8,552	7,482	6,133	11,652	11,652	8,893
Sum	130,211	106,730	202,788	154,759	130,211	233,395	191,308	363,484	363,484	277,396
Month	A17NS	A17NSa.f.	A17Shigh	A17Smiddle	A17Slow	A18NS	A18NSa.f.	A18high	A18Smiddle	A18Slow
	2,830		1.90	1.45	1.22	3,919		1.90	1.45	1.22
April	54,507	44,678	84,888	64,783	54,507	102,110	83,697	159,024	121,360	102,110
May	295,719	242,393	460,546	351,470	295,719	404,055	331,193	629,266	480,229	404,055
June	132,374	108,503	206,157	157,330	132,374	227,363	186,363	354,090	270,227	227,363
July	130,664	107,101	203,493	155,297	130,664	135,356	110,948	210,801	160,874	135,356
August	14,720	12,065	22,924	17,495	14,720	36,004	29,511	56,071	42,791	36,004
September	31,328	25,679	48,790	37,234	31,328	123,025	100,840	191,596	146,218	123,025
Sum	659,313	540,420	1,026,798	783,609	659,313	1,027,913	842,552	1,600,848	1,221,700	1,027,913

rvol99c, s11, p1

Table 15 (cont.) Range of Hypothetical Seeding Effects for the Hydrologic Areas in 1999

The units for the 1st column of each set are m**3 x 10**3; the units for all other columns are in acre-feet

Month	A19NS	A19NSa.f.	A19Shigh	A19Smiddle	A19Slow	A20NS	A20NSa.f.	A20Shigh	A20Smiddle	A20Slow
	8,385		1.90	1.45	1.22	4,081		1.90	1.45	1.22
April	221,909	181,893	345,596	263,745	221,909	97,872	80,223	152,424	116,323	97,872
May	1,294,577	1,061,128	2,016,144	1,538,636	1,294,577	642,545	526,677	1,000,686	763,681	642,545
June	473,121	387,804	736,828	562,316	473,121	329,285	269,906	512,821	391,363	329,285
July	196,295	160,898	305,706	233,302	196,295	197,386	161,792	307,405	234,599	197,386
August	58,426	47,890	90,992	69,441	58,426	27,743	22,740	43,206	32,973	27,743
September	362,326	296,988	564,278	430,633	362,326	198,844	162,987	309,675	236,331	198,844
Sum	2,606,654	2,136,602	4,059,543	3,098,073	2,606,654	1,493,676	1,224,324	2,326,216	1,775,270	1,493,676
Month	A21NS	A21NSa.f.	A21Shigh	A21Smiddle	A21Slow	A22NS	A22NSa.f.	A22Shigh	A22Smiddle	A22Slow
	6,190		1.90	1.45	1.22	498		1.90	1.90	1.45
April	250,869	205,630	390,697	298,164	250,869	9,885	8,103	15,395	15,395	11,749
May	207,255	169,881	322,774	246,328	207,255	39,793	32,617	61,973	61,973	47,295
June	391,650	321,025	609,947	465,486	391,650	27,065	22,184	42,150	42,150	32,167
July	256,377	210,145	399,275	304,710	256,377	25,372	20,797	39,514	39,514	30,155
August	57,867	47,432	90,121	68,777	57,867	1,115	914	1,736	1,736	1,325
September	80,875	66,291	125,953	96,122	80,875	3,763	3,084	5,860	5,860	4,472
Sum	1,244,894	1,020,405	1,938,769	1,479,587	1,244,894	106,992	87,699	166,627	166,627	127,163
Month	A23NS	A23NSa.f.	A23Shigh	A23Smiddle	A23Slow	A24NS	A24NSa.f.	A24Shigh	A24Smiddle	A24Slow
	1,120		1.90	1.45	1.22	10,371		1.45	1.22	1.11
April	35,517	29,113	55,314	42,213	35,517	361,951	296,681	430,187	361,951	329,316
May	181,787	149,006	283,112	216,059	181,787	480,834	394,126	571,483	480,834	437,480
June	61,244	50,200	95,379	72,789	61,244	381,868	313,007	453,860	381,868	347,438
July	85,871	70,386	133,733	102,060	85,871	168,462	138,084	200,221	168,462	153,273
August	2,180	1,787	3,395	2,591	2,180	66,198	54,260	78,678	66,198	60,229
September	7,619	6,245	11,865	9,055	7,619	90,356	74,063	107,391	90,356	82,209
Sum	374,218	306,736	582,799	444,768	374,218	1,549,670	1,270,221	1,841,821	1,549,670	1,409,945
Month	A25NS	A25NSa.f.	A25high	A25Smiddle	A25Slow	A26NS	A26NSa.f.	A26Shigh	A26Smiddle	A26Slow
	5,496		1.90	1.45	1.22	2,363		1.90	1.45	1.22
April	99,852	81,846	155,507	118,676	99,852	10,655	8,734	16,594	12,664	10,655
May	420,618	344,769	655,061	499,915	420,618	109,120	89,443	169,941	129,692	109,120
June	236,776	194,079	368,749	281,414	236,776	132,947	108,973	207,049	158,011	132,947
July	102,006	83,611	158,861	121,236	102,006	60,915	49,930	94,867	72,398	60,915
August	7,279	5,966	11,336	8,651	7,279	4,471	3,665	6,963	5,314	4,471
September	38,296	31,390	59,641	45,516	38,296	33,888	27,777	52,776	40,277	33,888
Sum	904,827	741,661	1,409,156	1,075,409	904,827	351,996	288,521	548,190	418,356	351,996

rvol99c, s11, p2

Table 15 (cont.) Range of Hypothetical Seeding Effects for the Hydrologic Areas in 1999

The units for the 1st column of each set are m**3 x 10**3; the units for all other columns are in acre-feet

Month	A27NS	A27NSa.f.	A27Shigh	A27Smiddle	A27Slow	A28NS	A28NSa.f.	A28high	A28Smiddle	A28Slow
	15,959		1.45	1.22	1.11	20,707		1.45	1.22	1.11
April	98,252	80,534	116,775	98,252	89,393	265,121	217,313	315,103	265,121	241,217
May	932,115	764,029	1,107,841	932,115	848,072	2,329,266	1,909,234	2,768,389	2,329,266	2,119,250
June	1,059,679	868,590	1,259,455	1,059,679	964,134	2,123,397	1,740,490	2,523,710	2,123,397	1,931,943
July	894,618	733,293	1,063,275	894,618	813,956	1,201,117	984,522	1,427,557	1,201,117	1,092,820
August	1,054,923	864,691	1,253,803	1,054,923	959,807	357,475	293,012	424,867	357,475	325,243
September	839,346	687,989	997,584	839,346	763,667	567,663	465,298	674,682	567,663	516,480
Sum	4,878,933	3,999,126	5,798,732	4,878,933	4,439,030	6,844,039	5,609,868	8,134,308	6,844,039	6,226,953
Month	A29NS	A29NSa.f.	A29high	A29Smiddle	A29Slow	A30NS	A30NSa.f.	A30Shigh	A30Smiddle	A30Slow
	16,547		1.45	1.22	1.11	14,032		1.45	1.22	1.11
April	311,494	255,323	370,219	311,494	283,409	615,180	504,246	731,157	615,180	559,713
May	1,901,716	1,558,784	2,260,237	1,901,716	1,730,250	352,653	289,060	419,137	352,653	320,857
June	1,566,329	1,283,876	1,861,621	1,566,329	1,425,103	906,355	742,914	1,077,226	906,355	824,635
July	1,140,715	935,012	1,355,768	1,140,715	1,037,864	287,978	236,048	342,269	287,978	262,013
August	289,815	237,553	344,453	289,815	263,684	192,942	158,149	229,316	192,942	175,545
September	537,024	440,183	638,266	537,024	488,604	275,346	225,693	327,255	275,346	250,520
Sum	5,747,094	4,710,733	6,830,563	5,747,094	5,228,914	2,630,455	2,156,111	3,126,360	2,630,455	2,393,283
Month	A31NS	A31NSa.f.	A31Shigh	A31Smiddle	A31min	A32NS	A32NSa.f.	A32Shigh	A32Smiddle	A32Slow
	14,149		1.45	1.22	1.11	15,289		1.45	1.22	1.11
April	806,427	661,006	958,459	806,427	733,717	1,047,660	858,738	1,245,170	1,047,660	953,199
May	651,271	533,829	774,052	651,271	592,550	961,583	788,183	1,142,865	961,583	874,883
June	1,100,156	901,768	1,307,563	1,100,156	1,000,962	1,377,314	1,128,946	1,636,972	1,377,314	1,253,130
July	412,894	338,438	490,735	412,894	375,666	737,748	604,711	876,832	737,748	671,230
August	74,285	60,889	88,290	74,285	67,587	278,822	228,543	331,387	278,822	253,682
September	554,944	454,872	659,565	554,944	504,908	898,667	736,612	1,068,088	898,667	817,640
Sum	3,599,978	2,950,802	4,278,663	3,599,978	3,275,390	5,301,794	4,345,733	6,301,313	5,301,794	4,823,764
Month	A33NS	A33NSa.f.	A33NShigh	A33NSmiddle	A33Slow	A34NS	A34NSa.f.	A34Shigh	A34Smiddle	A33Slow
	22,861		1.45	1.22	1.11	2,693		1.90	1.45	1.22
April	1,288,121	1,055,837	1,530,964	1,288,121	1,171,979	64,052	52,502	99,754	76,128	64,052
May	1,495,109	1,225,499	1,776,974	1,495,109	1,360,304	127,453	104,470	198,493	151,481	127,453
June	2,462,130	2,018,139	2,926,302	2,462,130	2,240,135	140,537	115,194	218,869	167,032	140,537
July	590,987	484,415	702,402	590,987	537,701	118,656	97,259	184,793	141,026	118,656
August	667,933	547,486	793,854	667,933	607,709	20,848	17,088	32,468	24,778	20,848
September	992,141	813,231	1,179,185	992,141	902,686	29,229	23,958	45,521	34,740	29,229
Sum	7,496,421	6,144,607	8,909,681	7,496,421	6,820,514	500,776	410,472	779,897	595,185	500,776

rvol99c, s11, p3

Table 15 (cont.) Range of Hypothetical Seeding Effects for the Hydrologic Areas in 1999

The units for the 1st column of each set are m**3 x 10**3; the units for all other columns are in acre-feet

Month	A35NS	A35NSa.f.	A35Shigh	A35Smiddle	A35Slow	A36NS	A36NSa.f.	A36Shigh	A36Smiddle	A36Slow
	1,762		1.90	1.45	1.22	4,503		1.90	1.45	1.22
April	53,321	43,706	83,041	63,373	53,321	178,464	146,282	277,935	212,108	178,464
May	204,358	167,507	318,263	242,885	204,358	448,202	367,379	698,019	532,699	448,202
June	84,627	69,366	131,796	100,581	84,627	430,294	352,700	670,130	511,415	430,294
July	51,486	42,201	80,182	61,192	51,486	88,820	72,804	138,327	105,565	88,820
August	8,476	6,947	13,200	10,074	8,476	34,934	28,634	54,405	41,520	34,934
September	32,326	26,497	50,344	38,421	32,326	100,533	82,404	156,568	119,486	100,533
Sum	434,594	356,224	676,826	516,525	434,594	1,281,247	1,050,203	1,995,385	1,522,794	1,281,247
Month	A37NS	A37NSa.f.	A37Shigh	A37Smiddle	A37Slow	A38NS	A38NSa.f.	A38Shigh	A38Smiddle	A38Slow
	2,583		1.90	1.45	1.22	11,985		1.45	1.22	1.11
April	121,163	99,314	188,697	144,006	121,163	259,733	212,896	308,699	259,733	236,314
May	454,578	372,605	707,949	540,277	454,578	1,263,878	1,035,966	1,502,150	1,263,878	1,149,922
June	159,258	130,540	248,025	189,282	159,258	727,496	596,308	864,647	727,496	661,902
July	36,758	30,129	57,246	43,688	36,758	554,373	454,404	658,886	554,373	504,388
August	32,108	26,318	50,005	38,161	32,108	126,123	103,380	149,901	126,123	114,751
September	115,703	94,838	180,193	137,516	115,703	190,707	156,317	226,660	190,707	173,512
Sum	919,568	753,745	1,432,115	1,092,930	919,568	3,122,310	2,559,270	3,710,942	3,122,310	2,840,790
Month	A39NS	A39NSa.f.	A39high	A39Smiddle	A39Slow	A40NS	A40NSa.f.	A40Shigh	A40Smiddle	A40Slow
	18,835		1.45	1.22	1.11	14,925		1.45	1.22	1.11
April	828,041	678,722	984,147	828,041	753,381	1,167,720	957,148	1,387,864	1,167,720	1,062,434
May	2,086,522	1,710,264	2,479,882	2,086,522	1,898,393	1,745,364	1,430,626	2,074,407	1,745,364	1,587,995
June	1,845,596	1,512,784	2,193,536	1,845,596	1,679,190	1,898,973	1,556,535	2,256,976	1,898,973	1,727,754
July	284,846	233,481	338,547	284,846	259,163	322,953	264,716	383,838	322,953	293,834
August	250,721	205,509	297,988	250,721	228,115	372,248	305,122	442,426	372,248	338,685
September	720,147	590,284	855,912	720,147	655,216	582,913	477,797	692,806	582,913	530,355
Sum	6,015,873	4,931,043	7,150,013	6,015,873	5,473,458	6,090,171	4,991,943	7,238,318	6,090,171	5,541,057
Month	A41NS	A41NSa.f.	A41Shigh	A41Smiddle	A41Slow	A42NS	A42NSa.f.	A42Shigh	A42Smiddle	A42Slow
	4,259		1.90	1.45	1.22	20,961		1.45	1.22	1.11
April	66,622	54,608	103,755	79,182	66,622	680,294	557,618	808,546	680,294	618,956
May	423,699	347,294	659,859	503,577	423,699	2,398,811	1,966,239	2,851,046	2,398,811	2,182,525
June	254,759	208,819	396,756	302,787	254,759	863,991	708,189	1,026,875	863,991	786,090
July	224,243	183,806	349,231	266,518	224,243	622,164	509,971	739,458	622,164	566,068
August	14,713	12,060	22,914	17,487	14,713	141,764	116,200	168,490	141,764	128,982
September	42,061	34,476	65,505	49,991	42,061	169,824	139,200	201,839	169,824	154,512
Sum	1,026,097	841,063	1,598,020	1,219,542	1,026,097	4,876,848	3,997,417	5,796,254	4,876,848	4,437,132

rvol99c, s11, p4

Table 15 (cont.) Range of Hypothetical Seeding Effects for the Hydrologic Areas in 1999

The units for the 1st column of each set are m**3 x 10**3; the units for all other columns are in acre-feet

Month	A43NS	A43NSa.f.	A43Shigh	A43Smiddle	A43Slow	A44NS	A44NSa.f.	A44Shigh	A44Smiddle	A44Slow
	46,551		1.45	1.22	1.11	8,509.00		1.90	1.45	1.22
April	1,815,009	1,487,712	2,157,182	1,815,009	1,651,360	128,021	104,935	199,377	152,156	128,021
May	3,069,762	2,516,198	3,648,487	3,069,762	2,792,980	958,997	786,063	1,493,520	1,139,792	958,997
June	3,946,028	3,234,449	4,689,951	3,946,028	3,590,238	807,170	661,615	1,257,068	959,341	807,170
July	888,341	728,149	1,055,815	888,341	808,245	370,280	303,508	576,666	440,087	370,280
August	612,126	501,743	727,527	612,126	556,934	141,041	115,607	219,654	167,630	141,041
September	1,455,327	1,192,891	1,729,692	1,455,327	1,324,109	174,914	143,372	272,407	207,890	174,914
Sum	11786592	9,661,141	14,008,655	11,786,592	10,723,867	2,580,423	2,115,101	4,018,692	3,066,897	2,580,423
Month	A45NS	A45NSa.f.	A45Shigh	A54Smiddle	A45Slow	A46NS	A46NSa.f.	A46Shigh	A46Smiddle	A46Slow
	4,297		1.90	1.45	1.22	19,319		1.45	1.22	1.11
April	144,382	118,346	224,857	171,602	144,382	415,074	340,225	493,326	415,074	377,649
May	251,607	206,235	391,846	299,041	251,607	837,109	686,155	994,924	837,109	761,632
June	239,005	195,906	372,222	284,064	239,005	1,336,673	1,095,633	1,588,668	1,336,673	1,216,153
July	141,524	116,003	220,406	168,204	141,524	658,826	540,021	783,030	658,826	599,423
August	52,303	42,871	81,456	62,163	52,303	756,660	620,213	899,309	756,660	688,437
September	52,303	42,871	81,456	62,163	52,303	201,816	165,423	239,864	201,816	183,620
Sum	881,124	722,233	1,372,242	1,047,238	881,124	4,206,158	3,447,670	4,999,122	4,206,158	3,826,914
Month	A47NS	A47NSa.f.	A47Shigh	A47Smiddle	A47Slow	A48NS	A48NSa.f.	A48Shigh	A48Smiddle	A48Slow
	3,102		1.90	1.45	1.22	11,686		1.45	1.22	1.11
April	174,823	143,297	272,265	207,781	174,823	239,746	196,513	284,944	239,746	218,130
May	101,439	83,147	157,978	120,562	101,439	1,215,846	996,595	1,445,062	1,215,846	1,106,220
June	137,715	112,881	214,474	163,677	137,715	862,949	707,335	1,025,636	862,949	785,142
July	85,289	69,909	132,827	101,368	85,289	607,914	498,291	722,521	607,914	553,103
August	24,163	19,806	37,631	28,718	24,163	126,722	103,870	150,612	126,722	115,296
September	34,764	28,495	54,140	41,318	34,764	395,265	323,988	469,782	395,265	359,627
Sum	558,192	457,534	869,315	663,425	558,192	3,448,442	2,826,591	4,098,558	3,448,442	3,137,516
Month	A49NS	A49NSa.f.	A49Shigh	A49Smiddle	A49Slow	A13NS	A13NSa.f.	A13Shigh	A13Smiddle	A13Slow
	17,773		1.45	1.22	1.11	1,745		1.90	1.45	1.22
April	601,654	493,159	715,081	601,654	547,407	5,157	4,227	8,031	6,129	5,157
May	3,077,178	2,522,277	3,657,301	3,077,178	2,799,727	12,303	10,084	19,161	14,623	12,303
June	960,236	787,078	1,141,264	960,236	873,657	27,324	22,397	42,554	32,475	27,324
July	356,172	291,944	423,319	356,172	324,058	68,516	56,161	106,705	81,433	68,516
August	170,050	139,385	202,108	170,050	154,717	53,422	43,788	83,198	63,493	53,422
September	908,266	744,480	1,079,497	908,266	826,373	17,190	14,091	26,772	20,431	17,190
Sum	6,073,556	4,978,324	7,218,570	6,073,556	5,525,940	178,755	146,521	278,389	212,455	178,755

rvol99c, s11, p5

revised

Table 15 (cont.) Range of Hypothetical Seeding Effects for the Hydrologic Areas in 1999

Month	A50NS	A50NSa.f.	A50Shigh	A50Smiddle	A50Slow	A51NS	A51NSa.f.	A51Shigh	A51Smiddle	A51Slow
	20,590		1.45	1.22	1.11	1,394,925		1.22	1.11	1.06
April	878,094	719,749	1,043,637	878,094	798,922	36,355,342	29,799,461	36,355,342	33,077,401	31,587,428
May	1,896,570	1,554,565	2,254,120	1,896,570	1,725,567	83,213,062	68,207,428	83,213,062	75,710,245	72,299,874
June	1,736,237	1,423,145	2,063,561	1,736,237	1,579,691	78,441,929	64,296,663	78,441,929	71,369,296	68,154,463
July	398,062	326,280	473,107	398,062	362,171	42,446,729	34,792,401	42,446,729	38,619,565	36,879,945
August	379,880	311,377	451,497	379,880	345,629	43,484,152	35,642,747	43,484,152	39,563,449	37,781,312
September	402,602	330,001	478,502	402,602	366,301	42,080,108	34,491,892	42,080,108	38,286,000	36,561,406
Sum	5,691,445	4,665,119	6,764,423	5,691,445	5,178,282	326,021,323	267,230,592	326,021,323	296,625,958	283,264,428

rvol99c, s11, p6 revised

Table 16 Range of Hypothetical Seeding Effects for the Hydrologic Areas in 2000

The units for the 1st column of each set are m³ x 10³; the units for all other columns are in acre-feet

Month	A1NS	A1NS(a.f.)	A1Shigh	A1Smiddle	A1Slow	A2NS	A2NS(a.f.)	A2Shigh	A2Smiddle	A2Slow
	319		1.90	1.90	1.45	505		1.90	1.90	1.45
April	11,000	9,017	17,131	17,131	13,074	11,398	9,343	17,751	17,751	13,547
May	16,845	13,808	26,235	26,235	20,021	34,094	27,946	53,097	53,097	40,522
June	14,543	11,920	22,648	22,648	17,284	27,193	22,289	42,350	42,350	32,319
July	12,387	10,153	19,292	19,292	14,723	8,064	6,610	12,559	12,559	9,584
August	2,126	1,743	3,311	3,311	2,527	6,399	5,245	9,965	9,965	7,605
September	9,384	7,692	14,615	14,615	11,154	27,085	22,201	42,181	42,181	32,191
Sum	66,286	54,333	103,233	103,233	78,783	114,233	93,633	177,903	177,903	135,768
Month	A3NS	A3NS(a.f.)	A3Shigh	A3Smiddle	A3Slow	A14NS	A14NSa.f.	A14Shigh	A14Smiddle	A14Slow
	845.00		1.90	1.90	1.45	2,391		1.90	1.45	1.22
April	24,422	20,018	38,034	38,034	29,026	12,995	10,651	20,237	15,444	12,995
May	53,196	43,604	82,847	82,847	63,225	45,008	36,892	70,094	53,493	45,008
June	67,995	55,733	105,893	105,893	80,813	80,861	66,279	125,931	96,105	80,861
July	13,173	10,797	20,515	20,515	15,656	13,781	11,296	21,463	16,379	13,781
August	11,187	9,169	17,422	17,422	13,296	4,369	3,581	6,804	5,192	4,369
September	45,202	37,051	70,397	70,397	53,724	33,444	27,413	52,085	39,749	33,444
Sum	215,174	176,373	335,108	335,108	255,740	190,457	156,112	296,613	226,362	190,457
Month	A15NS	A15NSa.f.	A15Shigh	A15Smiddle	A15Slow	A16NS	A16NSa.f.	A16Shigh	A16Smiddle	A16Slow
	608		1.90	1.45	1.22	1,023		1.90	1.90	1.45
April	14,895	12,209	23,198	17,704	14,895	29,197	23,932	45,470	45,470	34,701
May	27,338	22,408	42,576	32,492	27,338	71,841	58,886	111,884	111,884	85,385
June	35,384	29,003	55,106	42,054	35,384	57,939	47,491	90,233	90,233	68,862
July	5,845	4,791	9,103	6,947	5,845	7,969	6,532	12,411	12,411	9,472
August	6,252	5,125	9,737	7,431	6,252	13,071	10,714	20,356	20,356	15,535
September	16,071	13,173	25,029	19,101	16,071	26,517	21,735	41,297	41,297	31,516
Sum	105,786	86,710	164,749	125,729	105,786	206,534	169,290	321,652	321,652	245,471
Month	A17NS	A17NSa.f.	A17Shigh	A17Smiddle	A17Slow	A18NS	A18NSa.f.	A18high	A18Smiddle	A18Slow
	2,830	0.2329	1.90	1.45	1.22	3,919	0.2621	1.90	1.45	1.22
April	91,869	75,302	143,074	109,188	91,869	170,832	140,026	266,050	203,038	170,832
May	258,897	212,211	403,200	307,706	258,897	464,327	380,596	723,132	551,864	464,327
June	189,853	155,617	295,672	225,645	189,853	388,081	318,099	604,388	461,243	388,081
July	59,406	48,693	92,517	70,605	59,406	7,733	6,339	12,043	9,191	7,733
August	29,697	24,342	46,249	35,296	29,697	35,902	29,428	55,913	42,671	35,902
September	132,021	108,214	205,607	156,910	132,021	165,310	135,500	257,450	196,475	165,310
Sum	761,742	624,379	1,186,320	905,350	761,742	1,232,185	1,009,987	1,918,976	1,464,482	1,232,185

rvol00b, s8, p1 revised

Table 16 (cont.) Range of Hypothetical Seeding Effects for the Hydrologic Areas in 2000

The units for the 1st column of each set are m**3 x 10**3; the units for all other columns are in acre-feet

Month	A19NS	A19NSa.f.	A19Shigh	A19Smiddle	A19Slow	A20NS	A20NSa.f.	A20Shigh	A20Smiddle	A20Slow
	8,385		1.90	1.45	1.22	4,081		1.90	1.45	1.22
April	490,988	402,449	764,653	583,551	490,988	252,142	206,674	392,680	299,677	252,142
May	891,384	730,643	1,388,221	1,059,432	891,384	518,506	425,005	807,509	616,257	518,506
June	1,330,046	1,090,202	2,071,384	1,580,793	1,330,046	318,304	260,905	495,719	378,312	318,304
July	51,852	42,502	80,753	61,627	51,852	48,820	40,017	76,032	58,024	48,820
August	36,557	29,964	56,932	43,448	36,557	56,275	46,127	87,641	66,884	56,275
September	211,118	173,047	328,790	250,919	211,118	117,330	96,172	182,727	139,450	117,330
Sum	3,011,945	2,468,807	4,690,733	3,579,770	3,011,945	1,311,377	1,074,900	2,042,309	1,558,604	1,311,377
Month	A21NS	A21NSa.f.	A21Shigh	A21Smiddle	A21Slow	A22NS	A22NSa.f.	A22Shigh	A22Smiddle	A22Slow
	6,190		1.90	1.45	1.22	498		1.90	1.90	1.45
April	1,270,455	1,041,356	1,978,577	1,509,967	1,270,455	16,103	13,199	25,078	25,078	19,139
May	287,782	235,887	448,186	342,036	287,782	19,007	15,580	29,602	29,602	22,591
June	391,280	320,721	609,370	465,046	391,280	43,301	35,492	67,436	67,436	51,464
July	152,212	124,764	237,052	180,908	152,212	6,984	5,724	10,876	10,876	8,300
August	37,568	30,793	58,508	44,651	37,568	2,561	2,100	3,989	3,989	3,044
September	217,515	178,291	338,752	258,522	217,515	10,275	8,422	16,002	16,002	12,212
Sum	2,356,812	1,931,813	3,670,445	2,801,129	2,356,812	98,231	80,517	152,983	152,983	116,750
Month	A23NS	A23NSa.f.	A23Shigh	A23Smiddle	A23Slow	A24NS	A24NSa.f.	A24Shigh	A24Smiddle	A24Slow
	1,120		1.90	1.45	1.22	10,371		1.45	1.22	1.11
April	44,372	36,371	69,105	52,738	44,372	458,069	375,466	544,426	458,069	416,768
May	90,840	74,459	141,472	107,965	90,840	307,926	252,399	365,978	307,926	280,163
June	128,099	104,999	199,498	152,249	128,099	762,929	625,352	906,760	762,929	694,141
July	24,549	20,122	38,232	29,177	24,549	110,606	90,660	131,458	110,606	100,633
August	9,313	7,633	14,503	11,068	9,313	13,195	10,815	15,682	13,195	12,005
September	31,382	25,723	48,873	37,298	31,382	312,252	255,944	371,119	312,252	284,098
Sum	328,554	269,307	511,683	390,495	328,554	1,964,977	1,610,637	2,335,424	1,964,977	1,787,807
Month	A25NS	A25NSa.f.	A25high	A25Smiddle	A25Slow	A26NS	A26NSa.f.	A26Shigh	A26Smiddle	A26Slow
	5,496		1.90	1.45	1.22	2,363		1.90	1.45	1.22
April	58,878	48,261	91,696	69,978	58,878	13,212	10,830	20,576	15,703	13,212
May	60,314	49,438	93,932	71,685	60,314	22,201	18,197	34,575	26,386	22,201
June	355,232	291,174	553,230	422,202	355,232	162,458	133,163	253,009	193,086	162,458
July	61,504	50,413	95,785	73,099	61,504	25,996	21,308	40,485	30,896	25,996
August	22,069	18,089	34,369	26,229	22,069	20,543	16,838	31,993	24,416	20,543
September	128,968	105,711	200,851	153,281	128,968	2,503	2,051	3,898	2,975	2,503
Sum	686,965	563,086	1,069,863	816,474	686,965	246,913	202,387	384,536	293,462	246,913

rvol00b, s8, p2

revised

Table 16(cont.) Range of Hypothetical Seeding Effects for the Hydrologic Areas in 2000

The units for the 1st column of each set are m**3 x 10**3; the units for all other columns are in acre-feet

Month	A27NS	A27NSa.f.	A27Shigh	A27Smiddle	A27Slow	A28NS	A28NSa.f.	A28Shigh	A28Smiddle	A28Slow
	15,959		1.45	1.22	1.11	20,707		1.45	1.22	1.11
April	284,837	233,473	338,536	284,837	259,155	264,386	216,710	314,230	264,386	240,548
May	1,716,927	1,407,317	2,040,610	1,716,927	1,562,122	1,874,944	1,536,839	2,228,417	1,874,944	1,705,892
June	711,439	583,147	845,563	711,439	647,293	1,554,928	1,274,531	1,848,070	1,554,928	1,414,730
July	178,514	146,323	212,169	178,514	162,419	643,986	527,857	765,393	643,986	585,922
August	384,068	314,810	456,474	384,068	349,439	556,579	456,212	661,508	556,579	506,396
September	347,848	285,121	413,426	347,848	316,484	550,396	451,144	654,159	550,396	500,770
Sum	3,623,633	2,970,191	4,306,776	3,623,633	3,296,912	5,445,220	4,463,295	6,471,777	5,445,220	4,954,257
Month	A29NS	A29NSa.f.	A29Shigh	A29Smiddle	A29Slow	A30NS	A30NSa.f.	A30Shigh	A30Smiddle	A30Slow
	16,547		1.45	1.22	1.11	14,032		1.45	1.22	1.11
April	292,451	239,714	347,585	292,451	266,082	240,137	196,833	285,408	240,137	218,485
May	1,601,617	1,312,800	1,903,561	1,601,617	1,457,208	284,445	233,152	338,070	284,445	258,799
June	1,153,430	945,435	1,370,880	1,153,430	1,049,433	1,545,142	1,266,510	1,836,439	1,545,142	1,405,826
July	548,091	449,255	651,420	548,091	498,673	639,973	524,568	760,624	639,973	582,271
August	601,044	492,659	714,356	601,044	546,852	268,949	220,450	319,653	268,949	244,700
September	934,115	765,668	1,110,219	934,115	849,892	98,895	81,062	117,539	98,895	89,978
Sum	5,130,748	4,205,531	6,098,020	5,130,748	4,668,140	3,077,541	2,522,575	3,657,733	3,077,541	2,800,058
Month	A31NS	A31NSa.f.	A31Shigh	A31Smiddle	A31Slow	A32NS	A32NSa.f.	A32Shigh	A32Smiddle	A32Slow
	14,149		1.45	1.22	1.11	15,289		1.45	1.22	1.11
April	522,106	427,955	620,535	522,106	475,031	214,556	175,866	255,005	214,556	195,211
May	622,139	509,950	739,428	622,139	566,045	538,028	441,007	639,460	538,028	489,518
June	2,071,774	1,698,176	2,462,355	2,071,774	1,884,975	2,012,468	1,649,564	2,391,867	2,012,468	1,831,016
July	614,526	503,710	730,380	614,526	559,118	713,892	585,158	848,479	713,892	649,525
August	118,448	97,089	140,778	118,448	107,768	136,569	111,942	162,316	136,569	124,255
September	27,110	22,221	32,221	27,110	24,666	27,359	22,425	32,517	27,359	24,892
Sum	3,976,104	3,259,102	4,725,697	3,976,104	3,617,603	3,642,872	2,985,961	4,329,644	3,642,872	3,314,417
Month	A33NS	A33NSa.f.	A33NShigh	A33NSmiddle	A33NSlow	A34NS	A34NSa.f.	A34Shigh	A34NSmiddle	A33NSlow
	22,861	0.3279	1.45	1.22	1.11	2,693	0.1860	1.90	1.45	1.22
April	248,439	203,639	295,276	248,439	226,039	66,720	54,689	103,909	79,299	66,720
May	392,015	321,323	465,919	392,015	356,669	136,669	112,023	212,845	162,434	136,669
June	2,639,526	2,163,546	3,137,141	2,639,526	2,401,536	136,789	112,122	213,033	162,578	136,789
July	760,345	623,234	903,689	760,345	691,790	50,354	41,274	78,420	59,847	50,354
August	358,846	294,136	426,498	358,846	326,491	22,732	18,632	35,402	27,017	22,732
September	26,489	21,712	31,483	26,489	24,100	100,552	82,420	156,597	119,508	100,552
Sum	4,425,660	3,627,590	5,260,005	4,425,660	4,026,625	513,816	421,160	800,205	610,683	513,816

rvol00b, s8, p3

revised

Table 16 (cont.) Range of Hypothetical Seeding Effects for the Hydrologic Areas in 2000

The units for the 1st column of each set are m**3 x 10**3; the units for all other columns are in acre-feet

Month	A35NS	A35NSa.f.	A35Shigh	A35Smiddle	A35Slow	A36NS	A36NSa.f.	A36Shigh	A36Smiddle	A36Slow
	1,762		1.90	1.45	1.22	4,503		1.90	1.45	1.22
April	84,509	69,270	131,613	100,441	84,509	241,165	197,676	375,585	286,630	241,165
May	142,115	116,487	221,326	168,907	142,115	220,847	181,022	343,942	262,482	220,847
June	159,325	130,594	248,129	189,361	159,325	461,703	378,445	719,045	548,745	461,703
July	12,851	10,533	20,013	15,273	12,851	29,955	24,553	46,651	35,602	29,955
August	8,733	7,158	13,601	10,380	8,733	262	215	408	312	262
September	51,763	42,429	80,615	61,522	51,763	57,018	46,736	88,799	67,768	57,018
Sum	459,296	376,472	715,296	545,884	459,296	1,010,950	828,647	1,574,430	1,201,539	1,010,950
Month	A37NS	A37NSa.f.	A37Shigh	A37Smiddle	A37Slow	A38NS	A38NSa.f.	A38Shigh	A38Smiddle	A38Slow
	2,583		1.90	1.45	1.22	11,985		1.45	1.22	1.11
April	296,645	243,152	461,989	352,570	296,645	315,333	258,469	374,781	315,333	286,901
May	183,138	150,113	285,214	217,664	183,138	1,172,238	960,851	1,393,234	1,172,238	1,066,544
June	268,706	220,251	418,477	319,364	268,706	863,050	707,418	1,025,757	863,050	785,234
July	50,880	41,705	79,240	60,473	50,880	167,031	136,911	198,521	167,031	151,971
August	34	28	53	41	34	195,668	160,384	232,556	195,668	178,026
September	44,689	36,630	69,597	53,114	44,689	534,342	437,986	635,079	534,342	486,164
Sum	844,092	691,879	1,314,570	1,003,224	844,092	3,247,663	2,662,019	3,859,927	3,247,663	2,954,841
Month	A39NS	A39NSa.f.	A39Shigh	A39Smiddle	A39Slow	A40NS	A40NSa.f.	A40Shigh	A40Smiddle	A40Slow
	18,835		1.45	1.22	1.11	14,925		1.45	1.22	1.11
April	1,474,988	1,209,006	1,753,059	1,474,988	1,341,997	481,991	395,074	572,858	481,991	438,533
May	1,224,808	1,003,941	1,455,714	1,224,808	1,114,374	508,407	416,727	604,254	508,407	462,567
June	1,759,692	1,442,371	2,091,437	1,759,692	1,601,031	1,520,690	1,246,467	1,807,378	1,520,690	1,383,579
July	332,091	272,206	394,699	332,091	302,149	593,675	486,619	705,597	593,675	540,147
August	6,968	5,711	8,281	6,968	6,340	117,752	96,518	139,951	117,752	107,135
September	187,685	153,841	223,069	187,685	170,763	34,611	28,369	41,136	34,611	31,490
Sum	4,986,232	4,087,076	5,926,260	4,986,232	4,536,654	3,257,125	2,669,775	3,871,173	3,257,125	2,963,450
Month	A41NS	A41NSa.f.	A41Shigh	A41Smiddle	A41Slow	A42NS	A42NSa.f.	A42Shigh	A42Smiddle	A42Slow
	4,259		1.90	1.45	1.22	20,961		1.45	1.22	1.11
April	122,157	100,128	190,244	145,186	122,157	851,045	697,578	1,011,488	851,045	774,311
May	278,852	228,567	434,277	331,422	278,852	1,196,768	980,958	1,422,388	1,196,768	1,088,863
June	288,922	236,821	449,960	343,391	288,922	1,523,593	1,248,846	1,810,827	1,523,593	1,386,219
July	79,492	65,157	123,799	94,478	79,492	400,274	328,093	475,735	400,274	364,184
August	63,234	51,832	98,480	75,156	63,234	49,863	40,871	59,263	49,863	45,367
September	104,629	85,762	162,947	124,354	104,629	872,117	714,850	1,036,533	872,117	793,484
Sum	937,286	768,267	1,459,708	1,113,988	937,286	4,893,660	4,011,197	5,816,235	4,893,660	4,452,428

rvol00b, s8, p4

revised

Table 16 (cont.) Range of Hypothetical Seeding Effects for the Hydrologic Areas in 2000

The units for the 1st column of each set are m**3 x 10**3; the units for all other columns are in acre-feet

Month	A43NS	A43NSa.f.	A43Shigh	A43Smiddle	A43Slow	A44NS	A44NSa.f.	A44Shigh	A44Smiddle	A44Slow
	46,551		1.45	1.22	1.11	8,509		1.90	1.45	1.22
April	586,441	480,690	697,000	586,441	533,566	179,423	147,068	279,430	213,249	179,423
May	1,431,717	1,173,539	1,701,631	1,431,717	1,302,628	759,690	622,697	1,183,124	902,911	759,690
June	3,919,510	3,212,713	4,658,434	3,919,510	3,566,112	761,826	624,447	1,186,450	905,449	761,826
July	1,064,020	872,147	1,264,614	1,064,020	968,084	144,201	118,198	224,576	171,387	144,201
August	308,237	252,654	366,348	308,237	280,445	146,291	119,910	227,830	173,870	146,291
September	350,974	287,684	417,141	350,974	319,329	252,533	206,994	393,289	300,142	252,533
Sum	7,660,900	6,279,426	9,105,168	7,660,900	6,970,163	2,243,965	1,839,315	3,494,699	2,667,007	2,243,965
Month	A45NS	A45NSa.f.	A45Shigh	A45Smiddle	A45Slow	A46NS	A46NSa.f.	A46Shigh	A46Smiddle	A46Slow
	4,297		1.90	1.45	1.22	19,319		1.45	1.22	1.11
April	114,124	93,544	177,734	135,639	114,124	279,203	228,855	331,839	279,203	254,029
May	305,201	250,165	475,313	362,739	305,201	761,434	624,126	904,983	761,434	692,780
June	77,452	63,485	120,621	92,053	77,452	1,034,018	847,556	1,228,956	1,034,018	940,787
July	93,264	76,446	145,248	110,847	93,264	167,741	137,493	199,364	167,741	152,617
August	34,604	28,364	53,891	41,128	34,604	161,333	132,240	191,748	161,333	146,786
September	201,080	164,819	313,157	238,988	201,080	411,520	337,312	489,102	411,520	374,416
Sum	825,724	676,823	1,285,964	981,393	825,724	2,815,249	2,307,581	3,345,993	2,815,249	2,561,415
Month	A47NS	A47NSa.f.	A47Shigh	A47Smiddle	A47Slow	A48NS	A48NSa.f.	A48Shigh	A48Smiddle	A48Slow
	3,102		1.90	1.45	1.22	11,686		1.45	1.22	1.11
April	85,956	70,456	133,866	102,161	85,956	306,016	250,833	363,707	306,016	278,424
May	96,862	79,395	150,851	115,123	96,862	1,167,510	956,976	1,387,615	1,167,510	1,062,243
June	174,174	142,766	271,255	207,010	174,174	1,013,901	831,066	1,205,046	1,013,901	922,484
July	71,065	58,250	110,675	84,463	71,065	210,999	172,950	250,778	210,999	191,975
August	17,372	14,240	27,055	20,647	17,372	206,977	169,654	245,998	206,977	188,316
September	112,898	92,539	175,824	134,182	112,898	570,943	467,986	678,580	570,943	519,465
Sum	558,328	457,646	869,527	663,586	558,328	3,476,347	2,849,465	4,131,724	3,476,347	3,162,906
Month	A49NS	A49NSa.f.	A49Shigh	A49Smiddle	A49Slow	A13NS	A13NSa.f.	A13Shigh	A13Smiddle	A13Slow
	17,773		1.45	1.22	1.11	1,745		1.90	1.45	1.22
April	1,515,357	1,242,096	1,801,039	1,515,357	1,378,726	343	281	534	408	343
May	1,361,935	1,116,340	1,618,693	1,361,935	1,239,138	1,310	1,073	2,039	1,556	1,310
June	1,823,760	1,494,885	2,167,583	1,823,760	1,659,323	51,703	42,379	80,521	61,450	51,703
July	249,999	204,917	297,130	249,999	227,458	38,885	31,873	60,559	46,216	38,885
August	1,183	970	1,406	1,183	1,077	24,214	19,848	37,711	28,779	24,214
September	280,400	229,836	333,262	280,400	255,118	2,141	1,755	3,334	2,544	2,141
Sum	5,232,634	4,289,044	6,219,114	5,232,634	4,760,839	118,595	97,209	184,698	140,954	118,595

rvol00b, s8, p5 revised

Table 16 (cont.) Range of Hypothetical Seeding Effects for the Hydrologic Areas in 2000

The units for the 1st column of each set are $m^{**3} \times 10^{**3}$; the units for all other columns are in acre-feet

Month	A50NS	A50NSa.f.	A50Shigh	A50Smiddle	A50Slow	A51NS	A51NSa.f.	A51Shigh	A51Smiddle	A51Slow
	20,590		1.45	1.22	1.11	1,394,925		1.22	1.11	1.06
April	1,022,896	838,439	1,215,737	1,022,896	930,668	31,609,754	25,909,635	31,609,754	28,759,695	27,464,213
May	961,054	787,749	1,142,236	961,054	874,402	51,105,638	41,889,867	51,105,638	46,497,752	44,403,259
June	1,764,181	1,446,050	2,096,773	1,764,181	1,605,116	84,425,178	69,200,966	84,425,178	76,813,072	73,353,024
July	222,669	182,515	264,647	222,669	202,592	34,447,598	28,235,736	34,447,598	31,341,667	29,929,880
August	2,254	1,847	2,679	2,254	2,050	16,017,170	13,128,828	16,017,170	14,572,999	13,916,557
September	389,744	319,462	463,220	389,744	354,603	20,776,091	17,029,583	20,776,091	18,902,837	18,051,358
Sum	4,362,798	3,576,064	5,185,292	4,362,798	3,969,431	238,381,429	195,394,614	238,381,429	216,888,021	207,118,291

rvol00b, s8, p6

Table 17 Effects of Hypothetical Seeding as a Function of Rain Amount for the Seven Targets Operative in 1999

Target	All Days with Rain					Wettest 10% of Days with Rain				
	# R Days	RVOL NS	RVOL S	S-NS	S/NS	# R Days	RVOL NS	RVOL S	S-NS	S/NS
HP	122	15,059,498	28,004,821	12,945,323	1.86	12	9,197,045	17,307,358	8,110,313	1.88
CRMWD	85	3,574,722	6,636,622	3,061,900	1.86	9	1,792,654	3,335,281	1,542,627	1.86
WT	91	4,202,012	8,092,922	3,890,910	1.93	9	2,238,452	4,697,270	2,458,818	2.10
TB	89	2,203,155	3,813,174	1,610,019	1.73	9	1,154,375	1,926,225	771,850	1.67
EA	108	4,991,282	10,501,644	5,510,362	2.10	11	2,707,168	6,290,802	3,583,635	2.32
SWT	81	3,640,084	7,273,582	3,633,497	2.00	8	1,850,353	4,072,635	2,222,282	2.20
ST	92	4,558,739	8,829,006	4,270,267	1.94	9	2,264,057	4,850,992	2,586,935	2.14

Target	Wettest 50% of Days with Rain					Driest 50% of Days with Rain				
	# R Days	RVOL NS	RVOL S	S-NS	S/NS	# R Days	RVOL NS	RVOL S	S-NS	S/NS
HP	61	14,856,950	27,635,110	12,778,161	1.86	61	202,548	369,711	167,163	1.83
CRMWD	43	3,451,873	6,426,701	2,974,828	1.86	42	122,849	209,920	87,072	1.71
WT	46	4,086,838	7,885,562	3,798,724	1.93	45	115,174	207,361	92,186	1.80
TB	45	2,164,566	3,746,671	1,582,105	1.73	44	38,589	66,503	27,914	1.72
EA	54	4,933,652	10,391,092	5,457,440	2.11	54	57,630	110,553	52,922	1.92
SWT	41	3,517,904	7,086,180	3,568,277	2.01	40	122,181	187,401	65,221	1.53
ST	46	4,374,766	8,478,586	4,103,819	1.94	46	183,973	350,420	166,447	1.90

Note: A day with rain is defined as one with an RVOL value $\geq 10^{**5} \text{ m}^{**3}$

revised rvol99c, s7, p1

Table 18 Effects of Hypothetical Seeding as a Function of Rain Amount for the Nine Targets Operative in 2000

Target	All Days with Rain					Wettest 10% of Days with Rain				
	# R Days	RVOL NS	RVOL S	S-NS	S/NS	# R Days	RVOL NS	RVOL S	S-NS	S/NS
PH	103	8,996,102	16,634,238	7,638,136	1.85	10	5,103,780	9,592,377	4,488,597	1.88
NP	93	4,471,590	8,314,395	3,842,805	1.86	9	2,316,625	4,405,198	2,088,573	1.90
HP	117	9,828,324	21,072,298	11,243,974	2.14	12	5,139,982	11,821,265	6,681,284	2.30
CRMWD	62	1,921,206	3,948,632	2,027,426	2.06	6	984,803	2,077,141	1,092,338	2.11
WT	78	3,909,321	7,059,779	3,150,458	1.81	8	2,233,012	4,244,546	2,011,533	1.90
TB	75	1,795,499	3,300,761	1,505,261	1.84	8	1,049,788	1,904,840	855,052	1.81
EA	111	4,749,514	8,517,805	3,768,291	1.79	11	3,158,139	5,539,060	2,380,921	1.75
SWT	79	2,285,543	3,981,861	1,696,318	1.74	8	1,232,979	2,239,865	1,006,886	1.82
ST	78	3,469,424	6,651,678	3,182,254	1.92	8	1,932,206	3,835,008	1,902,802	1.98

Target	Wettest 50% of Days with Rain					Driest 50% of Days with Rain				
	# R Days	RVOL NS	RVOL S	S-NS	S/NS	# R Days	RVOL NS	RVOL S	S-NS	S/NS
PG	51	8,867,260	16,392,549	7,525,289	1.85	52	128,842	241,689	112,848	1.88
NP	46	4,343,536	8,136,173	3,792,637	1.87	47	128,054	178,222	50,168	1.39
HP	58	9,690,859	20,827,329	11,136,470	2.15	59	137,465	244,969	107,504	1.78
CRMWD	31	1,878,248	3,859,471	1,981,223	2.05	31	42,958	89,161	46,203	2.08
WT	39	3,849,799	6,954,302	3,104,503	1.81	39	59,523	105,477	45,955	1.77
TB	37	1,742,688	3,204,881	1,462,193	1.84	38	52,812	95,880	43,068	1.82
EA	55	4,724,126	8,469,789	3,745,664	1.79	56	25,388	48,016	22,627	1.89
SWT	39	2,220,237	3,859,898	1,639,661	1.74	40	65,306	133,259	67,953	2.04
ST	39	3,404,078	6,537,538	3,133,460	1.92	39	65,346	114,140	48,794	1.75

Note: A day with rain is defined as one with an RVOL value $\geq 10^{**5} \text{ m}^{**3}$

rvol00b, s5, p1

revised

To determine the hypothetical effect of seeding as a function of the natural rainfall in a given time period (e.g., a month) and target, the radar-estimated rainfalls were sorted in descending order from the greatest to the least after assignment of a seeding factor based on the satellite measured cloud structure. Thus, the sorted natural rainfalls brought their hypothetical seeded rainfalls with them. Then, the number of days with measurable rain in the period was determined. If one assumes for the purposes of illustration that a target had 20 days during a month with measurable rainfall, then the wettest two days are heavy rain days, the next wettest 8 days are moderate rain days and the remaining 10 days with rain are light rain days.

Mean natural (unseeded) and seeded rainfalls were then determined for each category and the hypothetical effect of seeding by category was determined. This was done by differencing the S and NS rainfalls to obtain volumetric increments and by forming the ratio of S to NS rainfall to obtain percentage increases. The results are summarized in Tables 17 and 18. Much can be learned from this presentation. First, 10% of the days with rain $> 10^5 \text{ m}^3$ produced 54% and 56% of the rainfall during the 1999 and 2000 seasons, respectively. Second, 50% of the days with rain exceeding the threshold during the 1999 and 2000 seasons produced 97% and 98% of the rain volume, respectively. The other halves of the days with rain were inconsequential in terms of rain production. Third, the percentage increases in rainfall due to hypothetical seeding are as large on the wettest 10% of the days as they are on the other days and the volumetric rain increments are larger on the wet days. If true, this suggests that there would be considerable benefit from seeding on days with heavy convective rainfall. This is somewhat of a surprise, since it was assumed that the internal cloud structure would be less suitable on such days. **These results also suggest that there is little to be gained by seeding on at least half of the days with rain, since doubling or even tripling the rainfall would still be of little consequence. The challenge is in identifying such unsuitable days in advance of the seeding operations so that project resources are not wasted in unproductive seeding operations.**

The effect of natural rainfall and its enhancement by seeding depends not only on total rain amount but also on its distribution in time. Fortunately, the data from this study make it possible to generate tabulations and time plots of the rainfall in all of the areas. An example for the San Antonio urban area is shown in Figure 10, which is a daily bar plot for the 2000 season. The data for the plots are provided in Table 19 in which the date and the radar-estimated Non-Seeded (NS) and Seed (S) rain volumes in acre-feet are listed. The maximum rain output (19,741 acre-feet) on any day occurred on September 12th. The rain output exceeded 13,000 acre-feet on three other days. The largest output over five days, exceeding 45,000 acre-feet, occurred in the period June 8 through 12, 2000.

In generating an estimate of the possible effect of seeding over the San Antonio urban area, it was noted that this small region, covering only 845 km^2 , is included in the Edwards seeding target for which the daily seeding factors have been derived from the satellite imagery. In this instance the seeding factors were accepted as calculated without downward revision by a factor of two, because the San Antonio area covers $< 1,000 \text{ km}^2$. Recall that the hypothetical seeding effects are retained as calculated for such small areas. The seeding factors were then applied to the daily radar-estimated rain volumes to obtain an estimate of the possible effect of seeding over the San Antonio urban area. The "seeded" rainfalls are listed in the third column of

Table 19 Daily Radar-Estimated Rain Volumes (af) in the San Antonio Urban Area in 2000

Date	RVOL(NS)	RVOL(S)	Date	RVOL(NS)	RVOL(S)	Date	RVOL(NS)	RVOL(S)
9-Apr	7	11	6-jun	0	1	3-Aug	294	717
10	654	1,459	7	0	1	4	51	116
11	3,901	10,688	8	1,196	1,782	5	3	5
12	388	865	9	12,140	14,325	6	0	0
13	0	0	10	13,845	16,337	7	106	191
14	0	1	11	5,044	5,952	8	1,588	2,731
15	93	187	12	5,584	8,097	9	78	135
16	0	0	13	29	50	10	11	19
17	0	0	14	47	93	11	1	2
18	19	35	15	730	1,620	12	0	1
19	1,361	2,313	16	21	52	13	0	0
20	16	27	17	2,102	5,761	14	358	651
21	0	0	18	4,257	5,023	15	21	39
22	133	231	19	23	29	16	0	0
23	1	2	20	45	62	17	1	1
24	0	0	21	1	1	18	6	11
25	0	0	22	0	0	19	0	0
26	0	0	23	4	8	20	17	32
27	79	139	24	9	16	21	4,086	8,009
28	3	5	25	0	0	22	368	722
29	0	1	26	0	1	23	48	94
30	13,362	24,052	27	0	0	24	36	70
1-May	4,718	8,540	28	0	0	25	945	1,852
2	3,045	5,542	29	1	2	26	0	0
3	4	7	30	1	2	27	0	0
4	3,415	6,283	1-Jul	0	0	28	0	0
5	11	20	2	0	0	29	0	0
6	0	0	3	0	0	30	8	15
7	1	2	4	1	1	31	3	6
8	0	0	5	3	5	1-Sep	27	52
9	167	317	6	53	98	2	24	46
10	3	6	7	2	4	3	0	0
11	7	12	8	0	1	4	40	75
12	8,551	16,418	9	3	6	5	33	62
13	39	76	10	33	58	6	0	0
14	12	23	11	0	0	7	0	0
15	0	0	12	2	3	8	82	147
16	0	0	13	19	32	9	67	118
17	0	0	14	20	34	10	2	4
18	27	53	15	2	3	11	15	27
19	14,985	29,371	16	0	0	12	19,741	33,756
20	1	2	17	0	0	13	1,557	3,472
21	3	6	18	0	0	14	8,426	14,408
22	7	13	19	0	0	15	7	12
23	0	0	20	46	80	16	0	0

24	0	0	21	0	0	17	0	0
25	2	4	22	1	1	18	0	0
26	273	466	23	875	1,497	19	1	1
27	8,293	14,845	24	34	66	20	231	291
28	32	61	25	9	20	21	126	148
29	3	6	26	2	6	22	2	2
30	3	6	27	90	245	23	59	70
31	0	0	28	0	0	24	6,612	7,802
1-Jun	15	34	29	172	412	25	0	0
2	377	792	30	8,981	20,027	26	0	0
3	256	502	31	451	1,234	27	0	0
4	9,595	26,291	August 1	1,140	3,123	28	0	0
5	408	991	2	4	9	29	0	0
						30	0	0

**Rain Volume (acre-feet) in the San Antonio Urban Area
During the 2000 Season**

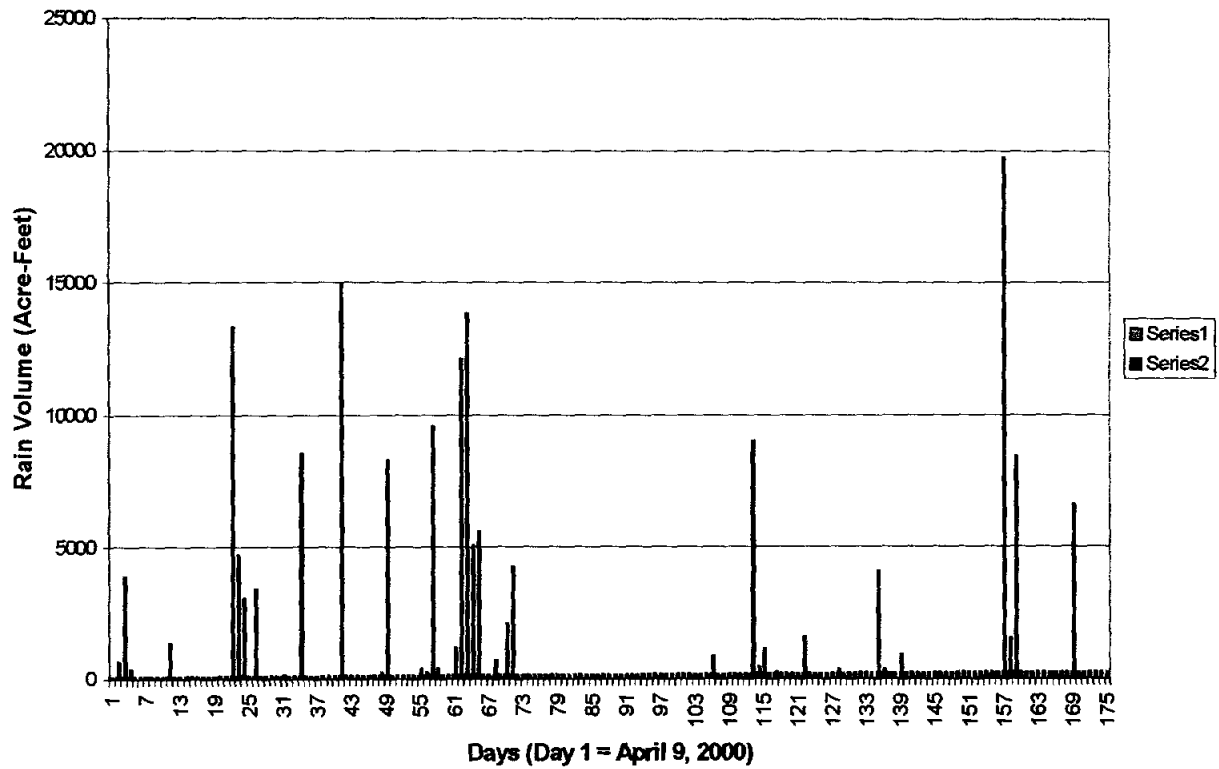

Figure 10. Rain volume (acre-feet) in the San Antonio urban area during the 2000 season (from rvol00b, chart 1)

each set of three in Table 19. A bar plot of the S and NS rainfalls is provided in Figure 11. The top of the “notch” in each bar marks the NS rainfall and the top of the entire bar is the total hypothetical S rainfall. (It is hard to distinguish between the two because the presentation has been “squeezed” in order to fit everything on one page.) Note that on many days the apparent seeding-induced rain increases are around 100% (i.e., a S/NS ratio of 2.0).

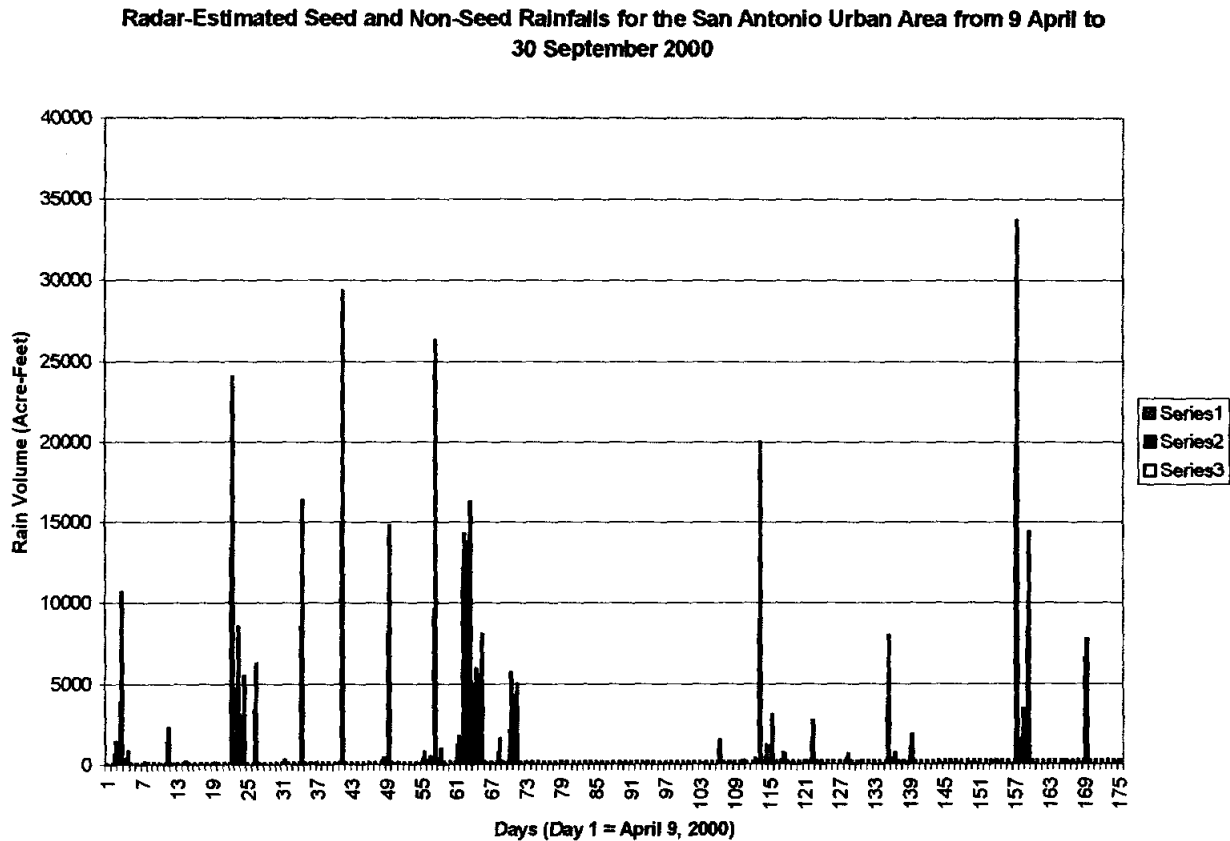

Figure 11. Radar-estimated seed and non-seed rainfalls for the San Antonio urban area from 9 April to 30 September 2000 (from rvol00b.chart 2).

To obtain a picture of the rain distribution in Texas during the 1999 and 2000 seasons area-averaged rainfalls (in mm) were calculated for each of the 51 areas. The results are provided in Table 20. In agreement with climatological expectations East Texas was considerably wetter than West Texas in both years. The Panhandle was quite wet in 1999 but less so in 2000. The wettest region for the two years combined was North Texas along the Red River to the north of Dallas-Ft. Worth.

The data also permit the production of rain maps for any area and for any time period. Seasonal rain maps for 1999 and 2000 are provided in Figures 12 and 13, respectively.

Table 20
Area-Average Seasonal Rainfall (mm) for the Texas Areas in 1999 and 2000

Area #	1999	2000	Area #	1999	2000
1	241	208	32	347	238
2	173	207	33	328	194
3	284	254	34	186	191
4	265	266	35	246	261
5	201	229	36	285	224
6	335	216	37	356	327
7	316	164	38	261	271
8	167	163	39	319	265
9	150	123	40	408	218
10	221	210	41	241	220
11	194	121	42	233	233
12	258	196	43	253	165
13	103	68	44	303	264
14	156	80	45	205	192
15	214	174	46	218	146
16	228	202	47	180	180
17	233	269	48	295	298
18	262	314	49	516	294
19	310	35	50	276	212
20	366	321	51	234	171
21	201	381			
22	213	197			
23	334	293			
24	150	190			
25	164	125			
26	149	105			
27	306	227			
28	331	263			
29	347	310			
30	187	219			
31	254	281			

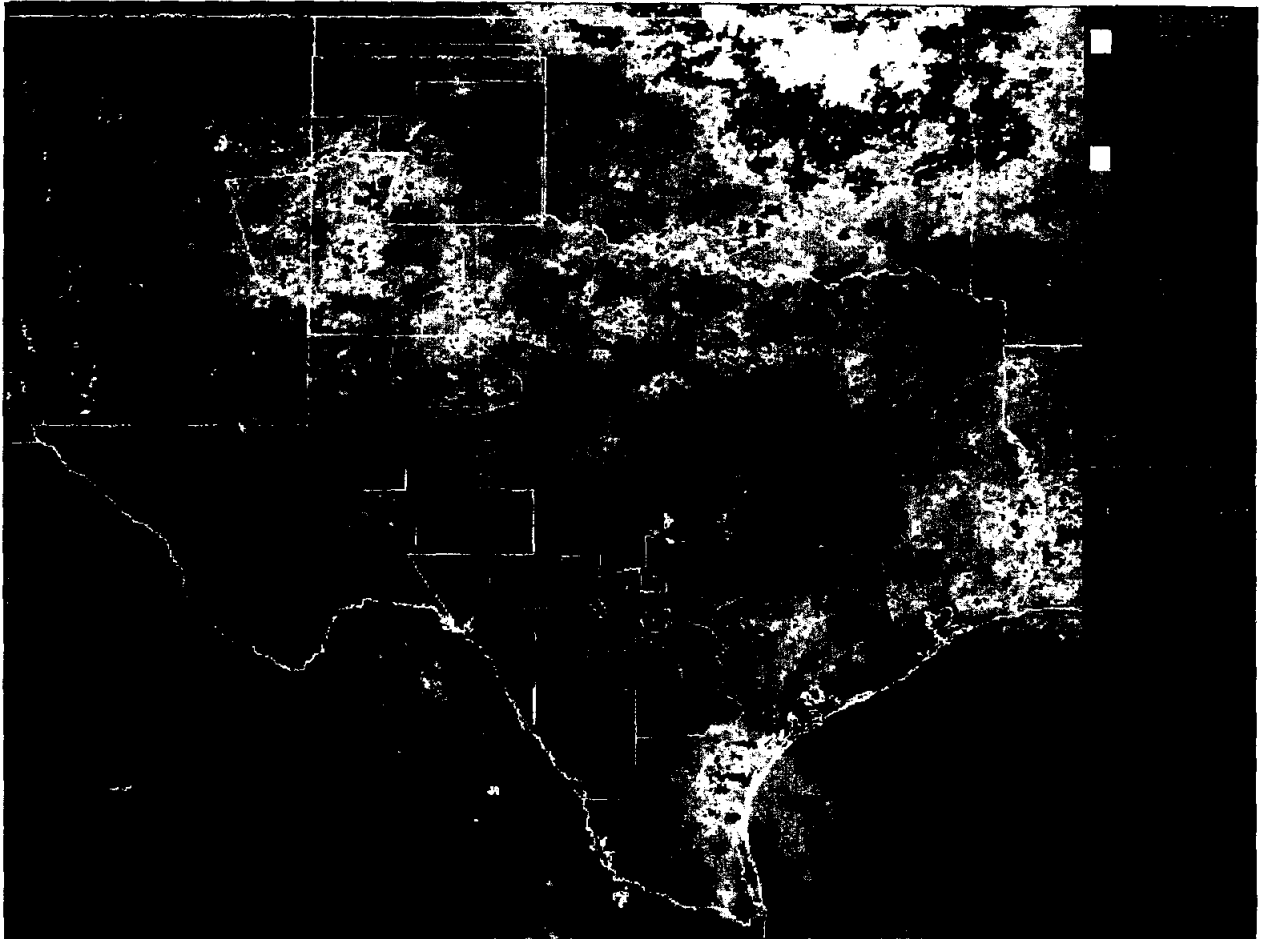

Figure 12. Radar-estimated rainfall (mm) in Texas in the period 10 April through 30 September 1999. The ten Texas seeding targets are superimposed. The key relating the colors to rain depth is at the upper right.

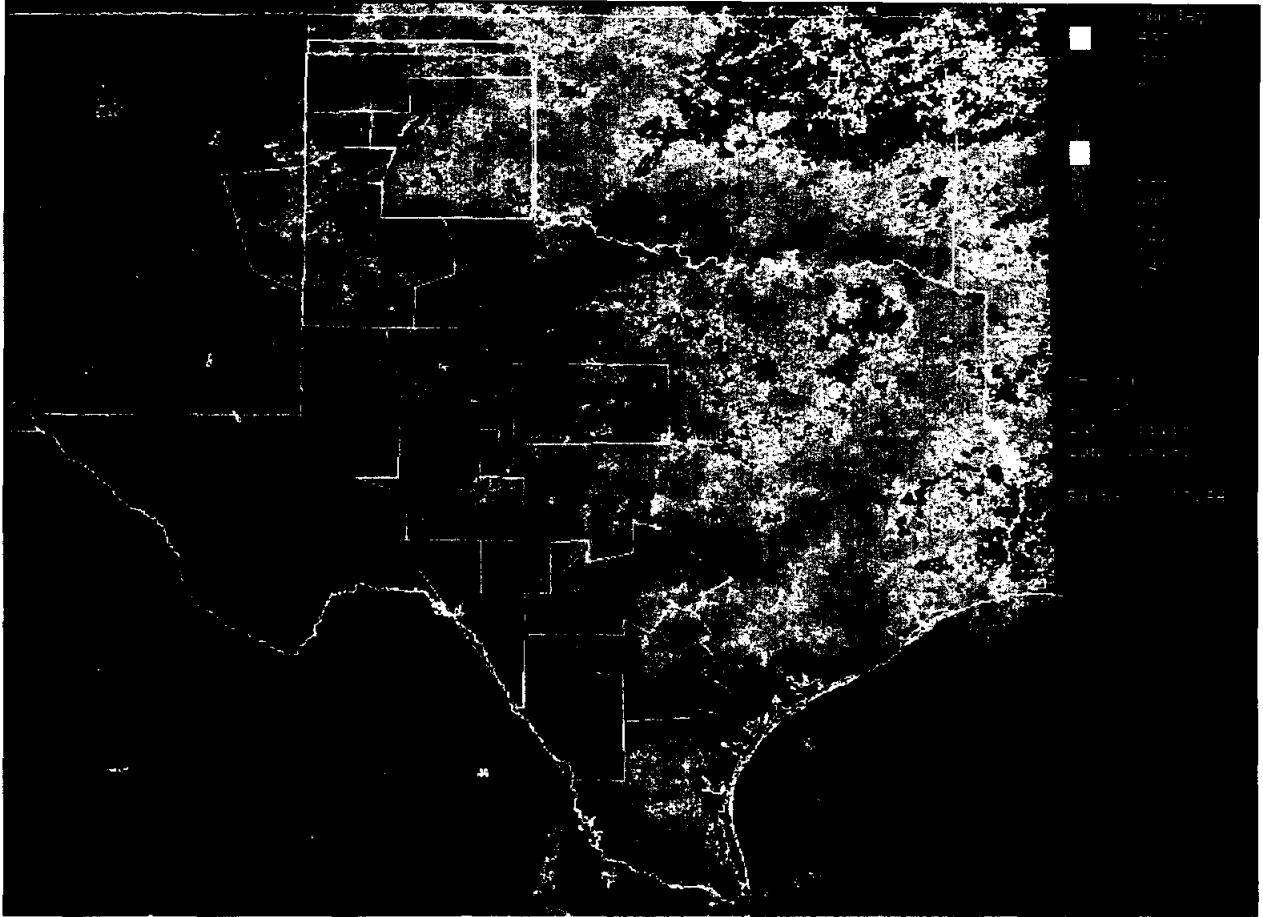

Figure 13. Radar-estimated rainfall (mm) in Texas in the period 10 April through 30 September 2000. The ten Texas seeding targets are superimposed. The key relating the colors to rain depth is at the upper right.

Before moving to the next section, it must be emphasized once again that all of the presentation and discussion is predicated on the assumption that the cloud seeding nucleant can be delivered in a timely fashion to the places it is needed in the clouds. This ideal may have been achieved for individual clouds. It may have been achieved also on some occasions over the floating target areas covering 1,964 km² that were used in the Texas and Thai randomized experiments. It was rarely accomplished over the FACE target covering 13,000 km², despite having three seeder aircraft available. It simply cannot be done on most days for larger areas in view of the aircraft resources typically devoted to the seeding effort. This must be kept in mind when assessing the results detailed in this report.

13.0 ESTIMATION OF THE IMPACTS OF INCREASED SEEDING-INDUCED RAINFALL ON TEXAS SURFACE WATER AND GROUNDWATER SUPPLIES

13.1 Introduction

Task 4 calls for an assessment of the hypothetical hydrological impacts of seeding-induced rainfall (HSIR) on major Texas river drainage basins and aquifers. Three assessments are conducted for this study. First, the general effects of HSIR are estimated for the discharge of five major Texas river basins: Brazos River, Colorado River, Guadalupe River, Nueces River, and Trinity River. Major streams such as the Canadian River, Pecos River, Red River, Rio Grande, and Sabine River are not included since significant portions of their watersheds extend outside of the Texas study area. Second, the general effects of HSIR on groundwater recharge are estimated for the following major Texas aquifers (as defined by the Texas Water Commission, Groundwater Protection Unit, 1989): Alluvium and Bolson aquifers, Carrizo-Wilcox Aquifer, Edwards (Balcones Fault Zone) Aquifer, Edwards-Trinity Aquifer, Gulf Coast Aquifer, Ogallala Aquifer, and Trinity Aquifer. Third, a smaller scale and more detailed study on the effects of HSIR on groundwater recharge is conducted and focused on portions of the San Antonio Segment of the Edwards (Balcones Fault Zone) Aquifer.

It is beyond the scope of this study to provide precise values on the effects of hypothetical HSIR on surface water and groundwater recharge. The primary goal of this investigation is to generate broad approximations of hydrologic response to hypothetical HSIR based on fundamental principles of surface water and groundwater flow, thus allowing future investigators to target areas for detailed research where the effects of HSIR would seem most advantageous.

To facilitate the presentation two appendices are provided. Appendix D provides a glossary of geologic and hydrologic terms used in this report. Appendix E is a conversion index from the metric International System of Units to English units. Metric units are primarily used in this report, although by request of the TWDB, water volume is expressed in the English unit of acre-feet.

13.2 Methodology

13.2.1 Hypothetical seeding-induced rainfall (HSIR)

The input data for this study are listed in Tables 15 and 16 in section 12.0. Several factors contribute to the impact of HSIR on surface water and groundwater. For example, some HSIR might be hydrologically insignificant, lost to evapotranspiration and into soils without any measurable effect on stream flows and aquifers. Other HSIR might only have a cumulative effect, with later storms producing greater measurable hydrologic impacts than earlier storms of similar intensity, but which contributed to soil saturation and other factors that promoted greater surface water runoff or groundwater recharge.

The HSIR values generated earlier include daily and monthly summaries. Certain assumptions must be made in selecting which values to use in this study. The values should

generate data that realistically reflect hydrological conditions and represent rainfall with the greatest likelihood of producing a hydrologically significant response, such as notably increasing stream flows and aquifer recharge. Consequently, and unless specified, HSIR values in this hydrologic analysis are based on monthly values. An attempt to use the daily values for this report found that they contain a high degree of variability due to local conditions. The variability occurs both within and between study areas and is too great to account for within the scope of this study. Using monthly values dilutes the effect of most daily variables, such as by:

- a) Reducing or eliminating the effects of antecedent rainfall by not focusing on hydrologic response to individual storms;
- b) Averaging available rainfall over broad areas with variable evapotranspiration (ET) rates;
- c) Reducing or eliminating the skewing of data from intense but localized storms in large study areas; and
- d) Averaging hydrologic response over broad areas that have variable hydrogeologic characteristics.

Tables 15 and 16 in the previous section provide estimates of maximum, minimum, and most likely HSIR. Projected hydrological responses to HSIR in this section likewise include maximum, minimum, and most likely values, and compare them to actual rainfall data for those periods.

13.2.2 Surface water calculations

The effects of HSIR on surface water in five major Texas watersheds are examined in this study: Brazos River, Colorado River, Guadalupe River, Nueces River, and Trinity River. The streams' drainage basins are too large to effectively assess the impacts of HSIR on stream discharge. Therefore, the stream systems are subdivided into 2-3 sub-basins, which still cover large areas, but have far less variation in hydrogeological, floral, and meteorological conditions. Figure 9 (presented earlier) illustrates the locations and shapes of the stream sub-basins and is keyed to Table 21, which lists the basins and their hydrologic attributes discussed below. Basin size and shape, while only roughly shown and measured, is generally within about 10% of the actual basin size and is adequate for the broad scope of this study.

The volume of water within a drainage basin is a direct function of precipitation and groundwater discharge, minus water lost to evaporation, transpiration, groundwater recharge, and human use. For the purposes of this study, the following assumptions are made about these factors:

- a) Precipitation equals either non-seeded rainfall (NSR) or HSIR for comparison.

Table 21: Surface water drainage basin key to Figure 9 and general hydrologic parameters.

Number	Drainage basin	Area (km ²)	Monthly mean PET*
Brazos River			
38	Lower basin	11,985	College Station
39	Middle basin	18,835	Wichita Falls
40	Upper basin	14,925	Lubbock
Colorado River			
41	Lower basin	4,259	Victoria
42	Middle basin	20,961	Austin
43	Upper basin	46,551	Midland
Guadalupe River			
44	Lower basin	8,509	Victoria
45	Upper basin	4,297	San Antonio
Nueces River			
46	Lower basin	19,319	San Antonio
47	Upper basin	3,102	Del Rio
Trinity River			
48	Lower basin	11,686	Houston
49	Upper basin	17,773	College Station

* The mean PET values for a particular month in Table 22 are used for the above-referenced cities.

- b) Groundwater discharge and recharge are not considered. This study examines the volume of water added to the drainage basins, and the amount of resident water in the basins' streams and lakes is not relevant. More importantly, over the month-long NSR/HSIR periods, it is assumed that any increase in groundwater discharge is a direct product of precipitation. Precipitation either has a short residence time as groundwater rapidly discharges to contribute to streamflow, or it slowly recharges to elevate local water tables and push out a volume of groundwater into streams that is roughly equal to the water that was recharged. Therefore, as a mean estimate for the month-long NSR/HSIR periods, there is no net stream gain or loss, or loss relative to groundwater.
- c) Human use of water is not considered. The volumes consumed in rural agricultural use and in urban settings can be considerable, but that draw does not affect the primary calculations in this study.
- d) Evaporation and transpiration are estimated based on data in Table 22.

In Table 21, evaporation and transpiration are combined as ET. While evaporation data for Texas are widely published (e.g. Lowry, 1960; Larkin and Bomar, 1983), transpiration and ET data are less available. Texas A&M University (2001) has posted Texas ET data on a website that are used in this report in Table 22. The data are for potential ET (PET), a rate based on temperature, relative humidity, wind speed, solar radiation, and water requirements of standard

plants in the area. The PET rates in Table 22 were calculated for the website using the Penman-Monteith method which the American Society of Civil Engineers and other organizations have proposed for use as a worldwide standard. The ET rates in Table 22 are the mean historic monthly PET. The city in Table 22 closest to or most representative of each drainage basin study area is listed in Table 21. Calculations for a drainage basin as discussed below that include PET, require use of the PET values for the month of interest in Table 22 for the city listed in Table 21.

Table 22: Average historic potential evapotranspiration for major Texas cities (Texas A&M University, 2001).

City	Average historic potential evapotranspiration (cm)						
	April	May	June	July	August	September	Mean
Abilene	11.94	20.07	21.87	22.23	20.70	18.03	19.20
Amarillo	12.70	22.56	24.69	24.41	22.73	17.27	20.73
Austin	13.39	19.18	21.03	20.62	20.83	15.80	18.47
Brownsville	13.49	17.48	18.57	19.28	18.62	15.19	17.09
College Station	13.26	19.23	21.21	20.83	21.36	15.88	18.62
Corpus Christi	13.49	17.70	19.13	20.04	18.92	15.11	17.40
Dallas/Ft. Worth	13.08	18.82	21.39	22.25	20.65	15.57	18.62
Del Rio	13.21	20.35	22.12	20.98	20.93	19.56	19.53
El Paso	14.22	22.56	25.17	23.47	21.13	19.30	20.98
Houston	13.28	19.00	20.52	19.79	19.76	15.39	17.96
Lubbock	13.72	21.26	23.44	23.01	20.98	16.76	19.86
Midland	14.22	21.84	23.44	23.11	21.21	19.30	20.52
Port Arthur	12.52	18.01	19.46	18.42	18.47	14.78	16.94
San Angelo	13.21	20.35	22.12	20.98	20.93	19.56	19.53
San Antonio	13.54	19.25	20.85	20.22	20.40	15.72	18.34
Victoria	13.16	18.11	19.43	20.17	19.28	15.47	17.60
Waco	13.36	19.18	21.29	22.20	21.01	16.00	18.85
Wichita Falls	11.43	20.04	22.50	23.39	21.59	17.02	19.33

The effects of HSIR on surface water within a drainage basin is calculated in this study as:

$$\Delta S = \{(HSIR - NSR) - [(PET \times N) \times A]\} \quad \text{eq. 1}$$

where ΔS is the volumetric difference in surface water in the drainage basin between NSR and HSIR (NSR and HSIR values provided by WWC), following the deduction of PET, the mean monthly potential ET for the drainage basins with the sizes listed in Table 21.

N is an adjustment factor for PET. ET occurs continuously, and PET in Table 22 is the monthly total PET for a given location. However, only the PET occurring during and immediately following the time of rainfall has an effect on equation 1. Using the monthly value for PET would produce a moisture deficit such that calculated rainfall would never reach the ground. Since most rainfall that produces significant runoff occurs during the larger storm

events, PET in equation 1 only reflects PET on the days that those storms occurred. In many areas, general experience suggests that a given depth of rainfall, typically 4-8 cm, is needed to produce significant surface runoff. However, such numbers are not available because the data developed by WWC are generalized for large areas. Instead, based on a review of the daily rainfall data provided by WWC, the large storm events are defined for this report as the largest order of magnitude of rainfall within a drainage basin for the basin's entire 1999-2000 period of record. These storms are all 100 million m³ magnitude events and account for 54-56% of the annual rainfalls. N represents the percentage of days within a given month that achieved precipitation within that highest level. Since most Texas storms do not last for entire days, each day with highest magnitude rainfall is counted as a 6-hour (0.25-day) period. Six hours is still longer than the period of most storms in a given location, but this approximation is used because it also accounts for ET during low magnitude storms that contribute small but notable volumes to surface water. When no storm of the highest magnitude occurs during a given month, N is set to equal 0.5%. This default percentage and the quarter-day increment were determined by testing several percentages for various precipitation periods and they provided the most realistic results. Limitations in the use of this method are examined in the Discussion section.

The volume of surface water determined by equation 1 reflects the "effective" precipitation within a drainage basin, the precipitation that reaches the ground and can potentially contribute to streamflow. In essence, equation 1 simplistically accounts for the ET and groundwater recharge that occur at the time of rainfall, but it does not reflect the volume of water subsequently loss to ET and recharge after the storm and which many never directly reach a stream. Table 23 approximates this loss and the amount of water that actually reaches the streams. It presents mean discharge data and drainage basin sizes from the U.S. Geological Survey (USGS) for the stream gauging station closest to or most representative of the rivers at the downstream end of the drainage basins, as defined in this report in Table 21 and Figure 9. In Table 23, historic mean annual discharge of the rivers is divided by each stream's drainage basin size to approximate the mean rates that effective precipitation contributes to the streams. Since each stream is divided into 2-3 drainage basins, the volume of discharge and the drainage area sizes of upstream segments are subtracted from the computations so upstream conditions won't skew the calculated hydrologic characteristics of the downstream basins. The results in Table 23 are applied later.

13.2.3 Aquifer recharge calculations

The general effects of HSIR on seven major Texas aquifers (as defined by the Texas Water Commission, Groundwater Protection Unit, 1989) are examined in this study: Alluvium and Bolson aquifers, Carrizo-Wilcox Aquifer, Edwards (Balcones Fault Zone) Aquifer, Edwards-Trinity Aquifer, Gulf Coast Aquifer, Ogallala Aquifer, and Trinity Aquifer. The aquifers cover areas too large to effectively evaluate the impacts of HSIR at those scales and are subdivided into as many as seven segments for better assessment. Springs, major streams, groundwater divides, structural features, lithologic changes, recharge zone boundaries, and meteorological conditions were used to segment the aquifers. The segments of the Edwards (Balcones Fault Zone) Aquifer have been defined in the hydrogeologic literature (e.g. Baker et al., 1986; Maclay, 1995), as has the Lower Glen Rose segment of the Trinity Aquifer (Veni, 1997). Other segments have not been formally described or have been modified for the purposes

of this study. Only one segment of the Alluvium and Bolson aquifers is included due to insufficient data available to study the other segments. The purpose of the segmentation is to identify aquifer areas with generally consistent internal hydrogeologic parameters, such as recharge rates, porosity, permeability, lithology, and transmissivity, as well as similar above-ground characteristics such as rainfall, soil and vegetation types, and topography.

Table 23: Stream drainage areas, discharges, and contributions from rainfall.

Drainage basin	Area (km ²)*	Mean historic discharge (acre-feet/year)*	Rainfall contribution to streamflow (acre-feet/year)/km ² **
Brazos River			
Lower basin	113,649	6,843	0.0397
Middle basin	76,594	2,327	0.0421
Upper basin	22,782	60	0.00263
Colorado River			
Lower basin	108,788	5,414	0.125
Middle basin	101,033	4,444	0.107
Upper basin	62,660	355	0.00567
Guadalupe River			
Lower basin	13,463	3,756	0.285
Upper basin	3,932	1,038	0.264
Nueces River			
Lower basin	39,956	1,353	0.0306
Upper basin	4,820	278	0.0577
Trinity River			
Lower basin	43,626	7,985	0.233
Upper basin	21,101	3,070	0.0145

* From Gandara, Gibbons, and Barbie (2001). Drainage area equals total upstream area, not the sub-drainage basin sizes in Table 21.

** Less upstream areas and discharges as described in the text.

Figures 7 and 8 illustrate the locations and shapes of the aquifer segments' recharge zones and keys them to Table 24, which lists the aquifers, their segments, and their hydrologic attributes discussed below. The size and shape of the aquifer segments are only roughly shown and measured, and most are within about 10% of their actual size. However, some segments are significantly less than 10% of their true sizes and focused on better-studied sections of the aquifers where the available data probably best represent the hydrogeologic conditions. The purpose of the segmentation is to identify aquifer areas with generally consistent internal hydrogeologic parameters, such as recharge rates, porosity, permeability, lithology and transmissivity, as well as similar above-ground characteristics such as rainfall, soil and vegetation types, and topography.

Table 24: Aquifer recharge zones key to Figures 7 and 8, and general hydrogeologic parameters.

Number	Aquifer segment	Area (km ²)	Historic mean recharge rate	Monthly mean PET*
Alluvium and Bolson aquifers				
13	Hueco-Mesilla Bolson	1,745	2.1%	El Paso
Carrizo-Wilcox Aquifer				
14	Rio Grande to Nueces River	2,391	5.3%	Del Rio
15	Nueces River to Guadalupe Rivr	608	8.0%	San Antonio
16	Guadalupe River to Colorado R.	1,024	5.0%	Austin
17	Colorado River to Brazos River	2,830	5.0%	Waco
18	Brazos River to Trinity River	3,919	5.0%	Dallas/Ft. Worth
19	Trinity River to Sulfur River	8,385	4.0%	Dallas/Ft. Worth
20	Eastern	4,081	4.0%	Houston
Edwards (Balcones Fault Zone) Aquifer				
21	San Antonio	6,190	15.7%	San Antonio
22	Barton Springs	498	21.7%	Austin
23	Northern	1,120	19.3%	Austin
Edwards-Trinity Aquifer				
24	Central	10,371	2.1%	San Angelo
25	Stockton Plateau	5,496	2.5%	Midland
26	Trans-Pecos	2,363	2.5%	Midland
Gulf Coast Aquifer				
27	Rio Grande to Nueces River	15,959	2.0%	Brownsville
28	Nueces River to Brazos River	20,707	2.0%	Corpus Christi
29	Brazos River to Sabine River	16,547	2.0%	Houston
Ogallala Aquifer				
30	Northwest	14,032	2.5%	Amarillo
31	Northeast	14,149	2.2%	Amarillo
32	Central	15,289	2.4%	Lubbock
33	Southern	22,861	2.7%	Lubbock
Trinity Aquifer				
34	Lower Glen Rose	2,693	20.1%	San Antonio
35	South Central	1,762	6.5%	Austin
36	North Central	4,503	4.0%	Waco
37	Northern	2,583	1.5%	Dallas/Ft. Worth

- The mean PET values for a particular month in Table 22 are used for the above-referenced cities.

The volume of water within an aquifer is a direct function of precipitation onto its recharge zone or contributing zone and the rate of recharge, minus water lost to evaporation, transpiration, overland runoff, groundwater discharge, and human use. For the purposes of this study, the following assumptions are made about these factors:

- a) Precipitation equals either NSR or HSIR for comparison. It is considered to occur over an aquifer's recharge zone, although some of the roughly drawn recharge zones may include portions of immediately adjacent contributing zones.
- b) Groundwater discharge is not considered. This study examines the volume of water added to aquifers, and the amount of resident or discharging water is not highly relevant. While elevated local water tables from recharge will push additional groundwater out from an aquifer, the relatively slow response of most aquifers to recharge should make little difference during the month-long NSR/HSIR periods.
- c) Human use of water is not considered. The volumes consumed in rural agricultural use and in urban settings can be considerable, but that draw does not affect the calculations in this study, which focus on recharge rate and not water levels within the aquifers. The aquifers where recharge rate may be significantly affected by water levels are identified in Appendix F, and that factor is considered in establishing a mean recharge rate for each aquifer. More detailed analysis of the effects of water levels on recharge rate is beyond the scope of this study.
- d) Evaporation and transpiration can be estimated based on data in Table 22 as described in the previous section on stream discharge calculations but are not considered for the reasons described in the next paragraph.

The primary value used in this study to assess the impact of HSIR on aquifer recharge is the mean percentage of precipitation that recharges an aquifer or aquifer segment. Recharge is the portion of precipitation that enters the ground after water loss to ET, runoff, and human use. Published sources are used to derive these percentages. For aquifers where such values have not been published, they are calculated by dividing published mean annual aquifer recharge rates by the estimated mean volume of annual precipitation. Brief descriptions of the aquifers and the literature and methods for determining mean annual recharge are presented in Appendix F. The volumetric change in recharge for an aquifer or aquifer segment is calculated by:

$$\Delta R = (\%R \times HSIR) - (\%R \times NSR) \quad \text{eq. 2}$$

where ΔR is the volumetric difference in recharge to an aquifer segment between NSR, the non-seeded rainfall for the aquifer area, and HSIR, the seeding-induced rainfall for the aquifer area, and where $\%R$ is the mean percentage of rainfall that recharges the aquifer. Both rainfall values are for the same periods of record.

Equation 2 was selected to estimate potential changes in aquifer recharge for this study after a careful examination and testing of other methods. Most hydrogeologic literature provides estimates of recharge into an aquifer but not the potential rates of recharge should there be greater rainfall. Potential recharge can be estimated in a variety of ways. Some of the methods examined for this investigation, but discounted for high uncertainty within the scope and data of

this study, include using measured aquifer discharge rates, using measured or calculated groundwater injection rates, or considering an aquifer's permeability, transmissivity or other related hydrologic parameters. Each method has limits and uncertainties. For example, aquifer permeability values are readily available in the literature. However, when applied to the surface to simulate recharge potential, they generate values at least an order of magnitude higher than reasonable since they would require recharge to include high percentages of water known to be lost to ET. Fogg (1989) examined some of the limitations and complexities in estimating groundwater recharge and flow with permeability values. Recharge could be estimated by deducting ET and runoff from rainfall, but runoff values are better determined through stormwater modeling programs that are beyond the scope of this study. Consequently, equation 2 was selected as the primary method with the lowest likely error based on this investigation's available data and resources.

13.2.4 Edwards Aquifer focused calculations

After determination of the general effects of HSIR, their potential impacts on water supplies are examined for periods of below-normal, normal, and above-normal rainfall. The San Antonio Segment of the Edwards (Balcones Fault Zone) Aquifer is assessed for this study. The Edwards Aquifer was selected for study for two primary reasons. First, while it is undoubtedly the most complex aquifer in Texas, it is also probably the most intensively studied. There are ample data that can be used to project the effects of cloud seeding on both the aquifer and regional rural and urban water use. Second, the aquifer is the sole water source for the city of San Antonio and other communities. San Antonio is the country's largest city that depends on a sole groundwater supply, and its growing population would benefit more from this investigation than any other community in Texas.

Due to the aquifer's complexity, existing hydrologic computer-driven models are not adequate for evaluating individual storm events or for detailed evaluations at the drainage basin scale. Conceptual water budget models are instead used to gauge the general impact of HSIR on the aquifer in three scenarios:

- 1) Assessing the general effects of HSIR on aquifer recharge and groundwater availability during periods of below-normal, normal, and above-normal rainfall;
- 2) Determining the effect of HSIR on groundwater in the aquifer in a selected recharging stream watershed; and
- 3) Calculating the net impact on the groundwater supply by comparing HSIR in the recharge zone with water usage subsequent to HSIR over rural agricultural and urban residential and industrial areas.

For the first scenario, the results of applying HSIR to the Edwards Aquifer's San Antonio Segment, as described in the previous section, are applied to historic aquifer data that represent periods of below-normal, normal, and above-normal rainfall. This is a general comparison on the impacts of HSIR and for when its application may be most advantageous. Pumping of the Edwards Aquifer is restricted based on set water use thresholds that protects federally listed endangered species that depend on its springflow. The results of this scenario may help focus

future HSIR research to better serve community needs while meeting or enhancing species protection.

For the second scenario, the Hondo Creek watershed is examined. Hondo Creek is located in Medina County and was selected as typical of mid-size streams that recharge the aquifer. It flows north to south from its upstream reaches for about 14 km and then flows an almost equal distance over the Edwards Aquifer recharge zone. The difference in aquifer recharge due to HSIR within the Hondo Creek watershed is calculated as:

$$\Delta R = \{HSIR - [(PET \times N) \times A] - L_{HSIR}\} - \{NSR - [(PET \times N) \times A] - L_{NSR}\} \text{ eq. 3}$$

In equation 3, ΔR is the volumetric difference in recharge to the aquifer in the watershed between NSR and HSIR for a given time period over the watershed, minus L. L is the volume of water lost to runoff, during the given time period, as gauged where Hondo Creek flows off of the recharge zone. L_{HSIR} reflects lost water during storms with rainfall and conditions comparable to that of the modeled HSIR, and L_{NSR} reflects gauged streamflow. Also in this equation, PET is the mean monthly potential ET for the drainage basin as given in Table 21, N is the adjustment percentage for PET as described for equation 1, and A is the 319.5-km² area of the watershed. The watershed is measured as the area upstream of the point where Hondo Creek flows off of the southern, downstream end of the recharge zone. HSIR events for Hondo Creek are compared to actual rainfall events in the watershed that had similar conditions and intensities in order to assess the probable effects of HSIR.

The third scenario examines the differences in the geographic application of HSIR. The amount of water within an aquifer is a function of the rate of recharge versus discharge. Much of the discharge in the Edwards Aquifer occurs from pumping for rural and urban use. This scenario examines if and when HSIR over non-recharge zone areas may be more beneficial than over the recharge zone by decreasing pumping demand for aquifer water. The effects of HSIR in an 845-km² area that covers the highly urbanized portions of the city of San Antonio are compared to changes in the city's water use by:

$$\Delta U = b[\{(HSIR - [(PET \times N) \times A]) - \{(NSR - [(PET \times N) \times A])\}/A] \text{ eq. 4}$$

where ΔU is the volumetric reduction in the city of San Antonio's pumping of water from the Edwards Aquifer based on b, the recession coefficient of pumping reductions per unit rainfall (described in greater detail later in this report), and the difference in NSR and HSIR over the city, compensating for ET as explained in the previous paragraph. ΔU will then be compared to HSIR changes in Edwards Aquifer recharge over a similar sized area of the recharge zone, based on the Hondo Creek and San Antonio Segment aquifer HSIR results, to determine where the application of HSIR may be most effective.

13.3 Data Analysis and Discussion

13.3.1 Surface water calculations

Tables 25-36 provide the monthly and "annual" (actually 6 months) NSR and the

maximum, likely, and minimum HSIR for the 15 surface water drainage basins for 1999 and 2000. They also include the volumetric difference in surface water between NSR and HSIR as calculated by equation 1. Δ Shigh is the maximum calculated difference. Δ Smiddle is the most likely calculated difference and Δ Slow is the minimum calculated difference. Any negative Δ S values are represented as zero since they are artifacts of the calculations, and no losses in surface water could occur by HSIR.

Table 25: Estimated potential effects of HSIR on surface water in the Lower Basin of the Brazos River; units are given in acre-feet.

Date	N	NSR	HSIR high	HSIR middle	HSIR low	Δ S high*	Δ S middle*	Δ S low*
April 1999	0.012	212,896	308,699	259,733	236,314	80,342	31,376	7,957
May 1999	0.040	1,035,966	1,502,150	1,263,878	1,149,922	391,447	153,175	39,219
June 1999	0.008	596,308	864,647	727,496	661,902	251,852	114,701	49,107
July 1999	0.005	454,404	658,886	554,373	504,388	194,363	89,850	39,865
August 1999	0.005	103,380	149,901	126,123	114,751	36,144	12,366	994
September 1999	0.005	156,317	226,660	190,707	173,512	62,628	26,675	9,480
1999 total	0.010	2,559,270	3,710,942	3,122,310	2,840,790	1,016,776	428,143	146,572
April 2000	0.010	258,469	374,781	315,333	286,901	103,428	43,980	15,548
May 2000	0.033	960,851	1,393,234	1,172,238	1,066,544	370,725	149,729	44,035
June 2000	0.033	707,418	1,025,757	863,050	785,234	250,332	87,625	9,809
July 2000	0.005	136,911	198,521	167,031	151,971	51,491	20,001	4,941
August 2000	0.005	160,384	232,556	195,668	178,026	61,795	24,907	7,265
September 2000	0.017	437,986	635,079	534,342	486,164	170,863	70,126	21,948
2000 total	0.017	2,662,019	3,859,927	3,247,663	2,954,841	1,008,634	396,368	103,546

* Based on a drainage area of 11,985 km² and the PET for College Station from Table 22.

Table 26: Estimated potential effects of HSIR on surface water in the Middle Basin of the Brazos River; units are given in acre-feet.

Date	N	NSR	HSIR high	HSIR middle	HSIR low	Δ S high*	Δ S middle*	Δ S low*
April 1999	0.025	678,722	984,147	828,041	753,381	261,792	105,686	31,026
May 1999	0.056	1,710,264	2,479,882	2,086,522	1,898,393	598,257	204,897	16,768
June 1999	0.067	1,512,784	2,193,536	1,845,596	1,679,190	450,563	102,623	0
July 1999	0.008	233,481	338,547	284,846	259,163	76,494	22,793	0
August 1999	0.005	205,509	297,988	250,721	228,115	75,996	28,729	6,123
September 1999	0.017	590,284	855,912	720,147	655,216	221,447	85,682	20,751
1999 total	0.029	4,931,043	7,150,013	6,015,873	5,473,458	1,684,549	550,346	74,668
April 2000	0.036	1,209,006	1,753,059	1,474,988	1,341,997	481,222	203,151	70,160
May 2000	0.024	1,003,941	1,455,714	1,224,808	1,114,374	378,333	147,427	36,993
June 2000	0.050	1,442,371	2,091,437	1,759,692	1,601,031	477,283	145,538	0
July 2000	0.005	272,206	394,699	332,091	302,149	104,635	42,027	12,085
August 2000	0.005	5,711	8,281	6,968	6,340	0	0	0
September 2000	0.005	153,841	223,069	187,685	170,763	56,234	20,850	3,928
2000 total	0.017	4,087,076	5,926,260	4,986,232	4,536,654	1,497,707	558,993	123,166

* Based on a drainage area of 18,835 km² and the PET for Wichita Falls from Table 22.

Table 27: Estimated potential effects of HSIR on surface water in the Upper Basin of the Brazos River; units are given in acre-feet.

Date	N	NSR	HSIR high	HSIR middle	HSIR low	ΔS high*	ΔS middle*	ΔS low*
April 1999	0.012	957,148	1,387,864	1,167,720	1,062,434	410,795	190,651	85,365
May 1999	0.048	1,430,626	2,074,407	1,745,364	1,587,995	520,306	191,263	33,894
June 1999	0.042	1,556,535	2,256,976	1,898,973	1,727,754	581,322	223,319	52,100
July 1999	0.008	264,716	383,838	322,953	293,834	96,849	35,964	6,845
August 1999	0.008	305,122	442,426	372,248	338,685	116,996	46,818	13,255
September 1999	0.025	477,797	692,806	582,913	530,355	164,311	54,418	1,860
1999 total	0.024	4,991,943	7,238,318	6,090,171	5,541,057	1,890,579	742,433	193,319
April 2000	0.012	395,074	572,858	481,991	438,533	157,863	66,996	23,538
May 2000	0.008	416,727	604,254	508,407	462,567	166,948	71,101	25,261
June 2000	0.033	1,246,467	1,807,378	1,520,690	1,383,579	467,317	180,629	43,518
July 2000	0.016	486,619	705,597	593,675	540,147	174,432	62,510	8,982
August 2000	0.005	96,518	139,951	117,752	107,135	30,740	7,924	0
September 2000	0.005	28,369	41,136	34,611	31,490	2,627	0	0
2000 total	0.011	2,669,775	3,871,173	3,257,125	2,963,450	999,927	389,160	101,299

* Based on a drainage area of 14,925 km² and the PET for Lubbock from Table 22.

Table 28: Estimated potential effects of HSIR on surface water in the Lower Basin of the Colorado River; units are given in acre-feet.

Date	N	NSR	HSIR high	HSIR middle	HSIR low	ΔS high*	ΔS middle*	ΔS low*
April 1999	0.005	54,608	103,755	79,182	66,622	46,875	22,302	9,742
May 1999	0.008	347,294	659,859	503,577	423,699	307,563	151,281	71,403
June 1999	0.005	208,819	396,756	302,787	254,759	184,583	90,614	42,586
July 1999	0.005	183,806	349,231	266,518	224,243	161,843	79,230	36,955
August 1999	0.005	12,060	22,914	17,487	14,713	7,526	2,099	0
September 1999	0.005	34,476	65,505	49,991	42,061	28,358	12,844	4,914
1999 total	0.001	841,063	1,598,020	1,219,542	1,026,097	736,748	358,370	165,603
April 2000	0.005	100,128	190,244	145,186	122,157	87,844	42,786	19,757
May 2000	0.008	228,567	434,277	331,422	278,852	200,708	97,853	45,283
June 2000	0.005	236,821	449,960	343,391	288,922	209,785	103,216	48,747
July 2000	0.005	65,157	123,799	94,478	79,492	55,160	25,829	10,853
August 2000	0.005	51,832	98,480	75,156	63,234	43,320	19,996	8,074
September 2000	0.005	85,762	162,947	124,354	104,629	74,514	35,921	16,196
2000 total	0.001	768,267	1,459,708	1,113,988	937,286	671,331	325,601	148,910

* Based on a drainage area of 4,259 km² and the PET for Victoria from Table 22.

Table 29: Estimated potential effects of HSIR on surface water in the Middle Basin of the Colorado River; units are given in acre-feet.

Date	N	NSR	HSIR high	HSIR middle	HSIR low	ΔS high*	ΔS middle*	ΔS low*
April 1999	0.024	557,618	808,546	680,294	618,956	196,319	68,067	6,729
May 1999	0.056	1,966,239	2,851,046	2,398,811	2,182,525	702,287	250,052	33,766
June 1999	0.017	708,189	1,026,875	863,991	786,090	257,934	95,050	17,149
July 1999	0.016	509,971	739,458	622,164	566,068	173,423	56,129	33
August 1999	0.008	116,200	168,490	141,764	128,982	23,973	0	0
September 1999	0.005	139,200	201,839	169,824	154,512	49,214	17,199	1,887
1999 total	0.020	3,997,417	5,796,254	4,876,848	4,437,132	1,403,150	486,497	29,174
April 2000	0.023	697,578	1,011,488	851,045	774,311	261,576	101,133	24,399
May 2000	0.040	980,958	1,422,388	1,196,768	1,088,863	311,059	85,439	0
June 2000	0.050	1,248,846	1,810,827	1,523,593	1,386,219	383,298	96,064	0
July 2000	0.008	328,093	475,735	400,274	364,184	119,610	44,149	8,059
August 2000	0.005	40,871	59,263	49,863	45,367	694	0	0
September 2000	0.017	714,850	1,036,533	872,117	793,484	276,040	111,624	32,991
2000 total	0.023	4,011,197	5,816,235	4,893,660	4,452,428	1,352,277	438,409	65,449

* Based on a drainage area of 20,961 km² and the PET for Austin from Table 22.

Table 30: Estimated potential effects of HSIR on surface water in the Upper Basin of the Colorado River; units are given in acre-feet.

Date	N	NSR	HSIR high	HSIR middle	HSIR low	ΔS high*	ΔS middle*	ΔS low*
April 1999	0.024	1,487,712	2,157,182	1,815,009	1,651,360	540,674	198,501	34,852
May 1999	0.081	2,516,198	3,648,487	3,069,762	2,792,980	464,672	0	0
June 1999	0.075	3,234,449	4,689,951	3,946,028	3,590,238	792,051	48,128	0
July 1999	0.040	728,149	1,055,815	888,341	808,245	0	0	0
August 1999	0.016	501,743	727,527	612,126	556,934	97,713	0	0
September 1999	0.033	1,192,891	1,729,692	1,455,327	1,324,109	298,442	22,077	0
1999 total	0.050	9,661,141	14,008,655	11,786,592	10,723,867	2,193,552	268,706	34,852
April 2000	0.023	480,690	697,000	586,441	533,566	92,881	0	0
May 2000	0.032	1,173,539	1,701,631	1,431,717	1,302,628	264,342	0	0
June 2000	0.083	3,212,713	4,658,434	3,919,510	3,566,112	711,502	0	0
July 2000	0.048	872,147	1,264,614	1,064,020	968,084	0	0	0
August 2000	0.008	252,654	366,348	308,237	280,445	49,659	0	0
September 2000	0.016	287,684	417,141	350,974	319,329	12,919	0	0
2000 total	0.036	6,279,426	9,105,168	7,660,900	6,970,163	1,131,303	0	0

* Based on a drainage area of 46,551 km² and the PET for Midland from Table 22.

Table 31: Estimated potential effects of HSIR on surface water in the Lower Basin of the Guadalupe River; units are given in acre-feet.

Date	N	NSR	HSIR high	HSIR middle	HSIR low	ΔS high*	ΔS middle*	ΔS low*
April 1999	0.005	104,935	199,377	152,156	128,021	89,903	42,682	18,547
May 1999	0.032	786,063	1,493,520	1,139,792	958,997	667,480	313,752	132,957
June 1999	0.016	661,615	1,257,068	959,341	807,170	574,008	276,281	124,110
July 1999	0.005	303,508	576,666	440,087	370,280	266,201	129,622	59,815
August 1999	0.005	115,607	219,654	167,630	141,041	97,397	45,373	18,784
September 1999	0.005	143,372	272,407	207,890	174,914	123,699	59,182	26,206
1999 total	0.009	2,115,101	4,018,692	3,066,897	2,580,423	1,818,688	866,892	380,419
April 2000	0.012	147,068	279,430	213,249	179,423	148,626	82,445	48,628
May 2000	0.024	622,697	1,183,124	902,911	759,690	530,694	250,481	107,260
June 2000	0.040	624,447	1,186,450	905,449	761,826	508,390	227,389	83,766
July 2000	0.005	118,198	224,576	171,387	144,201	99,421	46,232	19,046
August 2000	0.005	119,910	227,830	173,870	146,291	101,270	47,310	19,731
September 2000	0.005	206,994	393,289	300,142	252,533	179,645	86,498	38,889
2000 total	0.013	1,839,315	3,494,699	2,667,007	2,243,965	1,565,046	740,355	317,320

* Based on a drainage area of 8,509 km² and the PET for Victoria from Table 22.

Table 32: Estimated potential effects of HSIR on surface water in the Upper Basin of the Guadalupe River; units are given in acre-feet.

Date	N	NSR	HSIR high	HSIR middle	HSIR low	ΔS high*	ΔS middle*	ΔS low*
April 1999	0.005	118,346	224,857	171,602	144,382	104,153	50,898	23,678
May 1999	0.005	206,235	391,846	299,041	251,607	182,258	89,453	42,019
June 1999	0.005	195,906	372,222	284,064	239,005	172,684	84,526	39,467
July 1999	0.005	116,003	220,406	168,204	141,524	100,881	48,679	27,136
August 1999	0.005	42,871	81,456	62,163	52,303	35,032	15,739	5,879
September 1999	0.005	42,871	81,456	62,163	52,303	35,847	16,554	6,694
1999 total	0.001	722,233	1,372,242	1,047,238	881,124	630,855	305,849	144,873
April 2000	0.005	93,544	177,734	135,639	114,124	81,832	39,737	18,222
May 2000	0.005	250,165	475,313	362,739	305,201	221,795	109,221	51,683
June 2000	0.005	63,485	120,621	92,053	77,452	53,504	24,936	10,335
July 2000	0.005	76,446	145,248	110,847	93,264	65,280	30,879	13,296
August 2000	0.005	28,364	53,891	41,128	34,604	21,974	9,211	2,687
September 2000	0.008	164,819	313,157	238,988	201,080	143,957	69,788	31,880
2000 total	0.001	676,823	1,285,964	981,393	825,724	588,342	283,772	128,103

* Based on a drainage area of 4,297 km² and the PET for San Antonio from Table 22.

Table 33: Estimated potential effects of HSIR on surface water in the Lower Basin of the Nueces River; units are given in acre-feet.

Date	N	NSR	HSIR high	HSIR middle	HSIR low	ΔS high*	ΔS middle*	ΔS low*
April 1999	0.036	340,225	493,326	415,074	377,649	76,758	0	0
May 1999	0.024	686,155	994,924	837,109	761,632	236,411	78,596	3,119
June 1999	0.042	1,095,633	1,588,668	1,336,673	1,216,153	355,883	103,888	0
July 1999	0.016	540,021	783,030	658,826	599,423	192,339	68,135	8,732
August 1999	0.016	620,213	899,309	756,660	688,437	227,975	85,326	17,103
September 1999	0.005	165,423	239,864	201,816	183,620	62,131	24,083	5,887
1999 total	0.022	3,447,670	4,999,122	4,206,158	3,826,914	1,151,497	360,028	34,841
April 2000	0.011	228,855	331,839	279,203	254,029	79,657	27,021	1,847
May 2000	0.032	624,126	904,983	761,434	692,780	184,379	40,830	0
June 2000	0.025	847,556	1,228,956	1,034,018	940,787	299,762	104,824	11,593
July 2000	0.008	137,493	199,364	167,741	152,617	36,536	4,913	0
August 2000	0.005	132,240	191,748	161,333	146,786	43,533	13,118	0
September 2000	0.005	337,312	489,102	411,520	374,416	139,480	61,898	24,794
2000 total	0.013	2,307,581	3,345,993	2,815,249	2,561,415	783,347	252,604	38,234

* Based on a drainage area of 19,319 km² and the PET for San Antonio from Table 22.

Table 34: Estimated potential effects of HSIR on surface water in the Upper Basin of the Nueces River; units are given in acre-feet.

Date	N	NSR	HSIR high	HSIR middle	HSIR low	ΔS high*	ΔS middle*	ΔS low*
April 1999	0.012	143,297	272,265	207,781	174,823	124,982	60,468	27,540
May 1999	0.005	83,147	157,978	120,562	101,439	72,272	34,856	15,733
June 1999	0.005	112,881	214,474	163,677	137,715	98,812	48,015	22,053
July 1999	0.005	69,909	132,827	101,368	85,289	60,280	28,821	12,742
August 1999	0.005	19,806	37,631	28,718	24,163	15,193	6,280	1,725
September 1999	0.005	28,495	54,140	41,318	34,764	23,186	10,364	3,810
1999 total	0.001	457,534	869,315	663,425	558,192	394,725	188,804	83,603
April 2000	0.005	70,456	133,866	102,161	85,956	61,789	30,044	13,839
May 2000	0.005	79,395	150,851	115,123	96,862	68,897	33,169	14,908
June 2000	0.005	142,766	271,255	207,010	174,174	125,708	61,463	28,627
July 2000	0.005	58,250	110,675	84,463	71,065	49,787	23,575	10,177
August 2000	0.005	14,240	27,055	20,647	17,372	10,183	3,775	500
September 2000	0.005	92,539	175,824	134,182	112,898	80,826	39,184	17,900
2000 total	0.001	457,646	869,527	663,586	558,328	397,190	191,210	85,951

* Based on a drainage area of 3,102 km² and the PET for Del Rio from Table 22.

Table 35: Estimated potential effects of HSIR on surface water in the Lower Basin of the Trinity River; units are given in acre-feet.

Date	N	NSR	HSIR high	HSIR middle	HSIR low	ΔS high*	ΔS middle*	ΔS low*
April 1999	0.005	196,513	284,944	239,746	218,130	82,140	36,942	15,326
May 1999	0.032	996,595	1,445,062	1,215,846	1,106,220	390,866	161,650	52,024
June 1999	0.016	707,335	1,025,636	862,949	785,142	287,196	124,509	46,702
July 1999	0.005	498,291	722,521	607,914	553,103	214,856	100,249	45,438
August 1999	0.005	103,870	150,612	126,722	115,296	37,382	13,492	2,066
September 1999	0.005	323,988	469,782	395,265	359,627	138,504	63,987	28,349
1999 total	0.009	2,826,591	4,098,558	3,448,442	3,137,516	1,150,944	500,829	189,905
April 2000	0.011	250,833	363,707	306,016	278,424	99,035	41,344	13,752
May 2000	0.040	956,976	1,387,615	1,167,510	1,062,243	358,638	138,533	33,266
June 2000	0.025	831,066	1,205,046	1,013,901	922,484	325,379	134,234	42,817
July 2000	0.005	172,950	250,778	210,999	191,975	68,454	28,675	9,651
August 2000	0.005	169,654	245,998	206,977	188,316	66,984	27,963	9,302
September 2000	0.005	467,986	678,580	570,943	519,465	203,304	95,667	44,189
2000 total	0.013	2,849,465	4,131,724	3,476,347	3,162,906	1,121,794	425,072	152,977

* Based on a drainage area of 11,686 km² and the PET for Houston from Table 22.

Table 36: Estimated potential effects of HSIR on surface water in the Upper Basin of the Trinity River; units are given in acre-feet.

Date	N	NSR	HSIR high	HSIR middle	HSIR low	ΔS high*	ΔS middle*	ΔS low*
April 1999	0.036	493,159	715,081	601,654	547,407	153,141	39,714	0
May 1999	0.089	2,522,277	3,657,301	3,077,178	2,799,727	888,425	308,302	30,851
June 1999	0.025	787,078	1,141,264	960,236	873,657	277,784	96,756	10,177
July 1999	0.016	291,944	423,319	356,172	324,058	83,354	16,207	0
August 1999	0.005	139,385	202,108	170,050	154,717	47,335	15,277	0
September 1999	0.017	744,480	1,079,497	908,266	826,373	296,090	124,889	42,996
1999 total	0.030	4,978,324	7,218,570	6,073,556	5,525,940	1,746,129	601,145	84,024
April 2000	0.045	1,242,096	1,801,039	1,515,357	1,378,726	472,967	187,285	50,654
May 2000	0.048	1,116,340	1,618,693	1,361,935	1,239,138	369,356	112,598	0
June 2000	0.067	1,494,885	2,167,583	1,823,760	1,659,323	467,942	124,119	0
July 2000	0.005	204,917	297,130	249,999	227,458	77,206	30,075	7,534
August 2000	0.005	970	1,406	1,183	1,077	0	0	0
September 2000	0.008	229,836	333,262	280,400	255,118	85,121	32,259	6,977
2000 total	0.027	4,289,044	6,219,114	5,232,634	4,760,839	1,472,592	486,336	65,165

• Based on a drainage area of 17,773 km² and the PET for College Station from Table 22.

In assessing the results of the above surface water calculations, three primary factors are examined below: the limitations of the results, the changes in surface water volume throughout the drainage basins, and the changes in stream discharge.

13.3.2 Limits of the results

The assumptions used to calculate changes in surface water from HSIR generally produce what seem to be results within the range of probable values, but mainly for drainage areas less than about 10,000 km² in size. As drainage areas increase in size, so do the occurrences where ΔS is a negative number and shown as zero in Tables 25-36. The cause for this artifact in the calculations is that as basin areas increase in size beyond about 10,000 km², it is increasingly less likely that the entire basin is covered by a storm event producing a given volume of rainfall. Consequently, ET losses are calculated here for the entire basin and deducted from HSIR when they should only be calculated for the area where the rain and the actual relevant ET loss occurred. It is beyond the scope of this study to determine those specific areas or their sizes. The N factor was applied to better approximate actual ET, but if further studies were done using similar calculations, N should be determined on a sliding scale according to radar-determined rain areas and/or drainage basin size based on sensitivity testing of these and additional scenarios. The N factor also needs to be adjusted for months of high and low precipitation. While negative numbers were calculated for ΔS as basin size increased, they appeared primarily during particularly dry or wet periods.

The mid-range data for both precipitation and drainage basin size appear the most reliable in estimating ΔS . Nonetheless, even the more extreme basins, events, and results provide instructive conceptual understanding of the likely effects of HSIR.

13.3.3 Potential surface water impacts of HSIR

There are two main desired surface water effects of HSIR: general irrigation of pasture and cropland, and enhancement of streamflows. Tables 37-48 convert the ΔS results into the additional effective monthly precipitation due to HSIR within a drainage basin, and assume uniform distribution of the extra rainfall throughout the basin. The tables provide the total annual increases in rainfall for the 6-month period where seeding was modeled and would most likely occur. They then take the average of the two annual periods and give a mean percentage increase in rainfall for the region on an annual basis.

Figures 14-16 illustrate the maximum (P high), low (P low), and middle (P middle) changes in mean annual effective precipitation for the 12 drainage basins. Figure 14 presents the basins in largest to smallest order and shows how P low significantly increases as basin size decreases (the basin names are abbreviated). This is due to skewed results by insufficient accounting for ET in the larger basins, as previously discussed. The P low values are thus generally not reliable and are not considered further for this study, except to point out that they appear to have stabilized and may be reliable in basins less than 10,000 km² in size. As basin sizes shrink, values for P high and P middle show a possible slight increase but appear to be generally unaffected.

Table 37: Estimated gains in rainfall (P) from HSIR, uniformly distributed in the Lower Basin of the Brazos River; units are given in centimeters.

Date	P high	P middle	P low
April 1999	0.827	0.323	0.082
May 1999	4.029	1.576	0.404
June 1999	2.592	1.181	0.505
July 1999	2.000	0.924	0.410
August 1999	0.372	0.127	0.010
September 1999	0.645	0.275	0.098
1999 total	10.465	4.406	1.509
April 2000	1.064	0.453	0.160
May 2000	3.816	1.541	0.453
June 2000	2.576	0.902	0.101
July 2000	0.530	0.206	0.051
August 2000	0.636	0.256	0.075
September 2000	1.759	0.722	0.226
2000 total	10.381	4.080	1.066
Average gain in mean annual P*	9.74%	3.97%	1.20%

* Averaged for the basin as 107 cm/year based on Larkin and Bomar (1983).

Table 38: Estimated gains in rainfall (P) from HSIR, uniformly distributed in the Middle Basin of the Brazos River; units are given in centimeters.

Date	P high	P middle	P low
April 1999	1.714	0.692	0.203
May 1999	3.928	1.342	0.110
June 1999	2.951	0.672	0.000
July 1999	0.501	0.149	0.000
August 1999	0.498	0.188	0.040
September 1999	1.450	0.561	0.136
1999 total	11.042	3.604	0.489
April 2000	3.152	1.330	0.459
May 2000	2.478	0.965	0.242
June 2000	3.126	0.953	0.000
July 2000	0.685	0.275	0.079
August 2000	0.000	0.000	0.000
September 2000	0.368	0.137	0.026
2000 total	9.809	3.660	0.806
Average gain in mean annual P*	12.87%	4.48%	0.80%

* Averaged for the basin as 81 cm/year based on Larkin and Bomar (1983).

Table 39: Estimated gains in rainfall (P) from HSIR, uniformly distributed in the Upper Basin of the Brazos River; units are given in centimeters.

Date	P high	P middle	P low
April 1999	3.395	1.576	0.706
May 1999	4.300	1.581	0.280
June 1999	4.804	1.846	0.431
July 1999	0.800	0.297	0.057
August 1999	0.967	0.387	0.110
September 1999	1.358	0.450	0.015
1999 total	15.624	6.137	1.599
April 2000	1.305	0.554	0.195
May 2000	1.380	0.588	0.209
June 2000	3.862	1.493	0.360
July 2000	1.442	0.517	0.074
August 2000	0.254	0.065	0.000
September 2000	0.022	0.000	0.000
2000 total	8.265	3.217	0.838
Average gain in mean annual P*	23.42%	9.17%	2.39%

* Averaged for the basin as 51 cm/year based on Larkin and Bomar (1983).

Table 40: Estimated gains in rainfall (P) from HSIR, uniformly distributed in the Lower Basin of the Colorado River; units are given in centimeters.

Date	P high	P middle	P low
April 1999	1.358	0.646	0.282
May 1999	8.908	4.381	2.068
June 1999	5.346	2.624	1.233
July 1999	4.687	2.295	0.011
August 1999	0.218	0.061	0.000
September 1999	0.821	0.372	0.142
1999 total	21.338	10.379	3.736
April 2000	2.544	1.239	0.572
May 2000	5.813	2.834	0.572
June 2000	6.076	2.989	1.412
July 2000	1.598	0.748	0.314
August 2000	1.255	0.579	0.234
September 2000	2.158	1.040	0.469
2000 total	19.444	9.429	3.573
Average gain in mean annual P*	22.41%	10.88%	4.02%

* Averaged for the basin as 91 cm/year based on Larkin and Bomar (1983).

Table 41: Estimated gains in rainfall (P) from HSIR, uniformly distributed in the Middle Basin of the Colorado River; units are given in centimeters.

Date	P high	P middle	P low
April 1999	1.155	0.401	0.040
May 1999	4.133	1.471	0.199
June 1999	1.518	0.559	0.101
July 1999	1.021	0.330	0.000
August 1999	0.141	0.000	0.000
September 1999	0.290	0.101	0.011
1999 total	8.258	2.862	0.351
April 2000	1.539	0.595	0.146
May 2000	1.831	0.503	0.000
June 2000	2.256	0.565	0.000
July 2000	0.704	0.260	0.047
August 2000	0.004	0.000	0.000
September 2000	1.624	0.657	0.194
2000 total	7.958	2.580	0.387
Average gain in mean annual P*	12.28%	4.12%	0.56%

* Averaged for the basin as 66 cm/year based on Larkin and Bomar (1983).

Table 42: Estimated gains in rainfall (P) from HSIR, uniformly distributed in the Upper Basin of the Colorado River; units are given in centimeters.

Date	P high	P middle	P low
April 1999	3.182	1.168	0.205
May 1999	2.734	0.000	0.000
June 1999	4.661	0.283	0.000
July 1999	0.000	0.000	0.000
August 1999	0.575	0.000	0.000
September 1999	1.756	0.130	0.000
1999 total	12.908	1.581	0.205
April 2000	0.547	0.000	0.000
May 2000	1.556	0.000	0.000
June 2000	4.187	0.000	0.000
July 2000	0.000	0.000	0.000
August 2000	0.292	0.000	0.000
September 2000	0.076	0.000	0.000
2000 total	6.658	0.000	0.000
Average gain in mean annual P*	21.27%	17.18%	0.22%

* Averaged for the basin as 46 cm/year based on Larkin and Bomar (1983).

Table 43: Estimated gains in rainfall (P) from HSIR, uniformly distributed in the Lower Basin of the Guadalupe River; units are given in centimeters.

Date	P high	P middle	P low
April 1999	1.303	0.619	0.269
May 1999	9.676	4.548	1.927
June 1999	8.321	4.005	1.799
July 1999	3.859	1.879	0.867
August 1999	1.412	0.658	0.272
September 1999	1.793	0.858	0.380
1999 total	26.364	12.567	5.514
April 2000	2.155	1.195	0.705
May 2000	7.693	3.631	1.555
June 2000	7.370	3.296	1.214
July 2000	1.441	0.670	0.276
August 2000	1.468	0.686	0.286
September 2000	2.604	1.254	0.564
2000 total	22.731	10.732	4.600
Average gain in mean annual P*	28.54%	13.55%	5.88%

* Averaged for the basin as 86 cm/year based on Larkin and Bomar (1983).

Table 44: Estimated gains in rainfall (P) from HSIR, uniformly distributed in the Upper Basin of the Guadalupe River; units are given in centimeters.

Date	P high	P middle	P low
April 1999	2.990	1.461	0.680
May 1999	5.232	2.568	1.206
June 1999	4.957	2.426	1.133
July 1999	2.896	1.397	0.779
August 1999	1.006	0.452	0.169
September 1999	1.029	0.475	0.192
1999 total	18.11	8.779	4.159
April 2000	2.349	1.141	0.523
May 2000	6.367	3.135	1.483
June 2000	1.536	0.716	0.297
July 2000	1.874	0.886	0.382
August 2000	0.631	0.264	0.077
September 2000	4.132	2.003	0.915
2000 total	16.889	8.145	3.677
Average gain in mean annual P*	22.15%	10.71%	4.96%

* Averaged for the basin as 79 cm/year based on Larkin and Bomar (1983).

Table 45: Estimated gains in rainfall (P) from HSIR, uniformly distributed in the Lower Basin of the Nueces River; units are given in centimeters.

Date	P high	P middle	P low
April 1999	0.490	0.000	0.000
May 1999	1.509	0.502	0.020
June 1999	2.272	0.663	0.000
July 1999	1.228	0.435	0.056
August 1999	1.456	0.545	0.109
September 1999	0.397	0.154	0.038
1999 total	7.352	2.299	0.223
April 2000	0.509	0.173	0.012
May 2000	1.177	0.261	0.000
June 2000	1.914	0.669	0.074
July 2000	0.233	0.031	0.000
August 2000	0.278	0.084	0.000
September 2000	0.891	0.395	0.158
2000 total	5.002	1.613	0.244
Average gain in mean annual P*	9.36%	2.96%	0.35%

* Averaged for the basin as 66 cm/year based on Larkin and Bomar (1983).

Table 46: Estimated gains in rainfall (P) from HSIR, uniformly distributed in the Upper Basin of the Nueces River; units are given in centimeters.

Date	P high	P middle	P low
April 1999	4.970	2.404	1.095
May 1999	2.874	1.386	0.626
June 1999	3.929	1.909	0.877
July 1999	2.397	1.146	0.507
August 1999	0.604	0.250	0.069
September 1999	0.922	0.412	0.152
1999 total	15.696	7.507	3.326
April 2000	2.461	1.195	0.550
May 2000	2.740	1.319	0.593
June 2000	4.999	2.444	1.138
July 2000	1.980	0.937	0.405
August 2000	0.405	0.150	0.012
September 2000	3.214	1.558	0.712
2000 total	15.799	7.603	3.410
Average gain in mean annual P*	27.15%	13.03%	5.81%

* Averaged for the basin as 58 cm/year based on Larkin and Bomar (1983).

Table 47: Estimated gains in rainfall (P) from HSIR, uniformly distributed in the Lower Basin of the Trinity River; units are given in centimeters.

Date	P high	P middle	P low
April 1999	0.867	0.390	0.162
May 1999	4.126	1.706	0.549
June 1999	3.031	1.314	0.493
July 1999	2.268	1.058	0.480
August 1999	0.395	0.142	0.022
September 1999	1.462	0.675	0.299
1999 total	12.149	5.285	2.005
April 2000	1.045	0.436	0.145
May 2000	3.786	1.462	0.351
June 2000	3.434	1.417	0.452
July 2000	0.723	0.303	0.102
August 2000	0.707	0.295	0.098
September 2000	2.146	1.010	0.466
2000 total	11.841	4.923	1.614
Average gain in mean annual P*	10.17%	4.33%	1.53%

* Averaged for the basin as 118 cm/year based on Larkin and Bomar (1983).

Table 48: Estimated gains in rainfall (P) from HSIR, uniformly distributed in the Upper Basin of the Trinity River; units are given in centimeters.

Date	P high	P middle	P low
April 1999	1.063	0.276	0.000
May 1999	6.166	2.140	0.214
June 1999	1.928	0.672	0.071
July 1999	0.579	0.112	0.000
August 1999	0.329	0.106	0.000
September 1999	2.055	0.867	0.298
1999 total	12.120	4.173	0.583
April 2000	3.283	1.300	0.352
May 2000	2.563	0.781	0.000
June 2000	3.248	0.861	0.000
July 2000	0.536	0.209	0.052
August 2000	0.000	0.000	0.000
September 2000	0.591	0.224	0.048
2000 total	10.221	3.375	0.452
Average gain in mean annual P*	13.30%	4.49%	0.62%

Averaged for the basin as 84 cm/year based on Larkin and Bomar (1983).

Figure 15 arranges the drainage basins in order of highest to lowest mean annual historic precipitation. P high and P middle show a respective overall mean increase of about 10% and 13% in the drier basins over their increases in the wetter basins. This is important because it illustrates that HSIR will have the proportionally greatest effects in the more arid areas where HSIR is most needed. Figure 16 also illustrates this trend by arranging the basins from the highest to lowest P middle values and showing a general increase in mean precipitation of about 30 cm/year across the basins.

The mean P middle percentages are distributed in two groups. The Lower and Middle basins of the Brazos River, the Middle Basin of the Colorado River, the Lower Basin of the Nueces River, and the Lower and Upper basins of the Trinity River show only 2.96 to 4.49% mean annual increase in likely effective precipitation. In contrast, the Upper Basin of the Brazos River, the Lower and Upper basins of the Colorado and Guadalupe rivers, and the Upper Basin of the Nueces River proportionally exhibit at least 2-3 times as much added effective rainfall with mean annual increases of 9.17 to 17.18%.

HSIR requires appropriate meteorological conditions to produce significant precipitation. These conditions generally do not occur in August, and only occasionally occur in July and September. Based on data in Tables 37-48, these three months combined produce P middle values that are only 26.6% of the annual total (ranging from 8.2 to 49.3%), while accounting for 50% of each year's 6-month calendar period.

13.3.4 Estimated potential streamflow impacts of HSIR

The second often-desired surface water effect from HSIR is streamflow enhancement. Given the conditions and assumptions described in this report's methodology, all or most of the effective precipitation would be available as runoff that could enter streams within the defined drainage basins. The total monthly volume of additional discharge for each basin can be determined directly from the totals given in Tables 25-36 and divided by 30 or 31 for total additional daily discharge. However, this water would be distributed throughout a river and its tributary streams and much would be lost to ET and groundwater recharge in transit to the streams. Table 23 addresses the water loss, but there is no known published value that can be used to determine the volumetric distribution of water throughout the stream channels. Many Texas streams, especially in the central and western portions of the state, have few flowing tributaries and gain much of their baseflow from groundwater discharge. Dams along many of the streams further complicate the issue.

Figure 14: Comparison of drainage basin size to mean precipitation and changes in effective precipitation from SIR

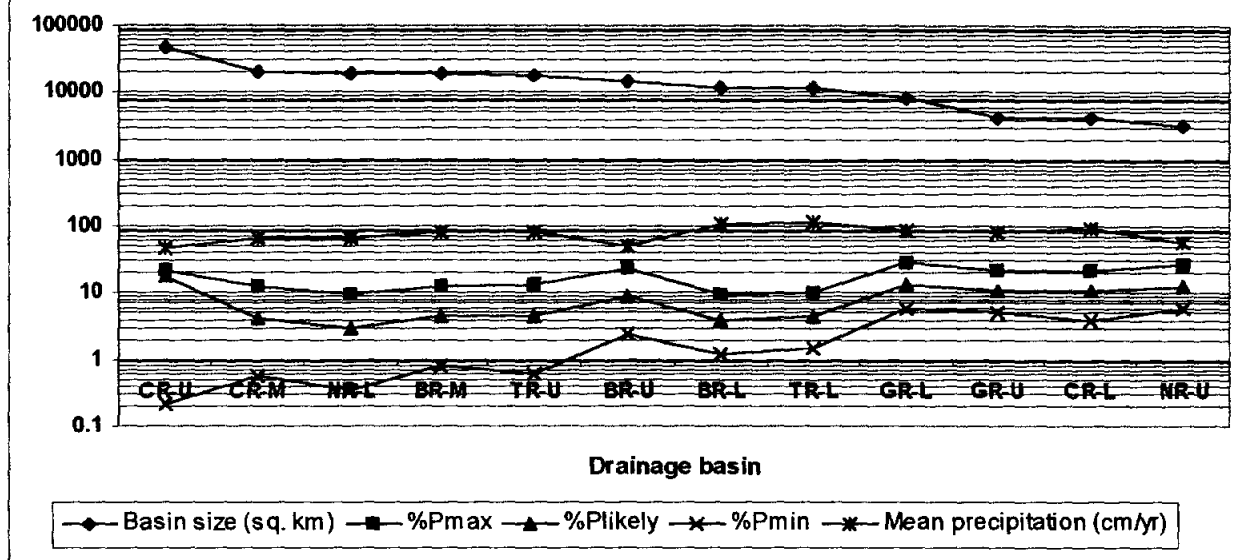

Figure 15: Comparison of mean annual precipitation to basin size, mean precipitation, and changes in effective precipitation from SIR

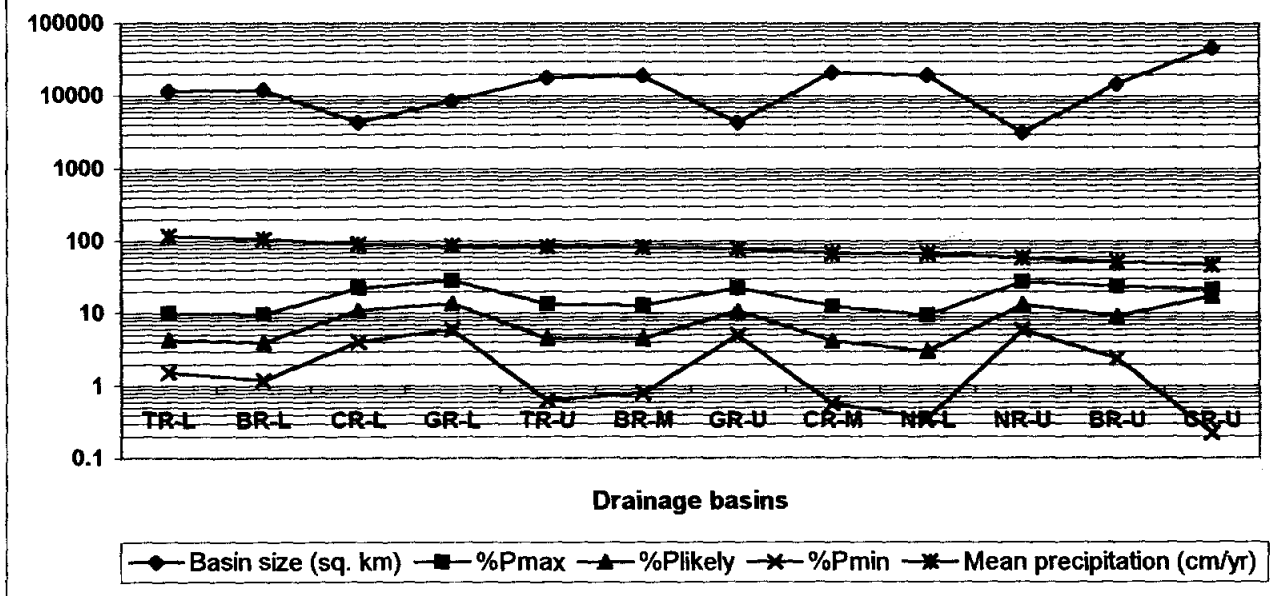
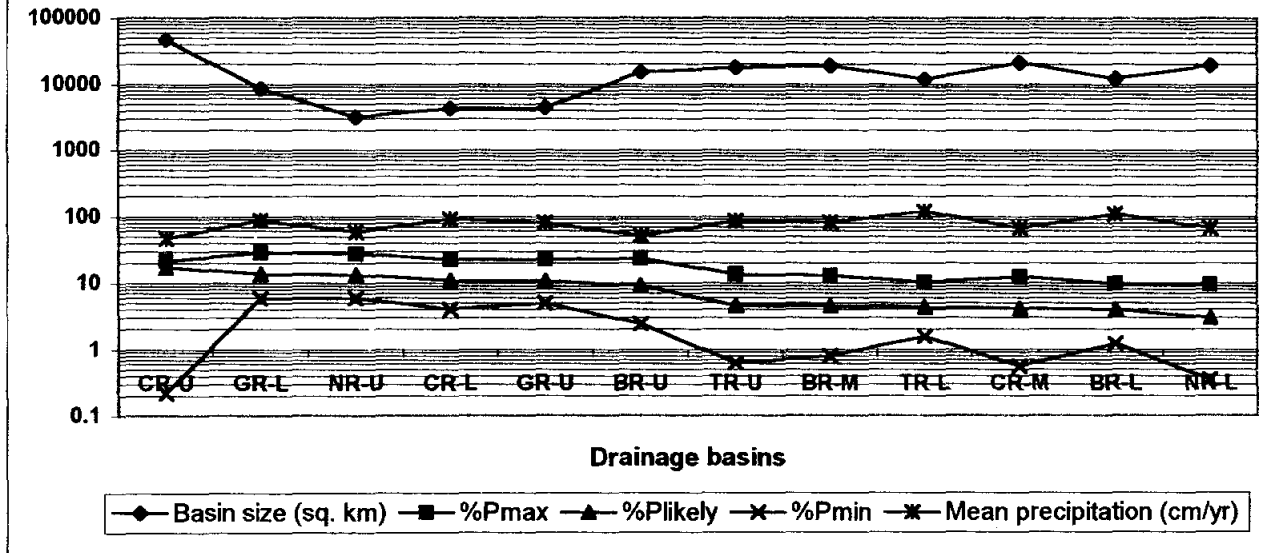

Figure 16: Comparison of the most likely changes in effective precipitation from SIR to basin size and mean precipitation



While the volume of water within the streams of a drainage basin is difficult to quantify, stream discharge is more easily measured and the data more readily available. Tables 49-60 provide Q_{tot} , the total measured monthly and annual discharges of the major rivers examined in this report, plus the estimated increases in discharge from HSIR. As with the previous tables in this hydrologic analysis section of this report, "annual" refers to the 6-month period of record in which HSIR is calculated for 1999 and 2000. The measured Q_{tot} discharge data are from the USGS gauging station closest to or most representative of the rivers at the downstream end of the drainage basins as defined in this report. Values for ΔQ_{max} , ΔQ_{likely} , and ΔQ_{min} are calculated as the maximum, likely, and minimum changes in river discharge due to HSIR by:

$$\Delta Q = \Delta S \times F \quad \text{eq. 5}$$

where ΔS is the change in effective precipitation due to HSIR given in Tables 25-36 as ΔS_{high} , ΔS_{middle} , and ΔS_{low} , and F is the mean portion of effective precipitation in a drainage basin that contributes to the river as given in Table 23. The percent differences in river discharge between NSR and HSIR conditions are also provided in Tables 49-60 as $\Delta Q\%$ for each month and annual HSIR period, and is calculated as:

$$\Delta Q\% = \Delta Q / Q_{tot} \quad \text{eq. 6}$$

Table 49: Estimated effects of HSIR on the flow of the Brazos River in the Lower Basin; units are given in acre-feet except where marked as percentages.

Date	Qtot*	ΔQ_{high}	ΔQ_{middle}	ΔQ_{low}	$\Delta Q_{high}\%$	$\Delta Q_{mid}\%$	$\Delta Q_{low}\%$
April 1999	212,700	3,190	1,246	316	1.50	0.59	0.15
May 1999	201,800	15,540	6,081	1,557	7.70	3.01	0.77
June 1999	116,000	9,999	4,554	1,950	8.62	3.93	1.68
July 1999	101,200	7,716	3,567	1,583	7.62	3.52	1.56
August 1999	70,640	1,435	491	39	2.03	0.70	0.06
September 1999	30,730	2,486	1,059	376	8.09	3.45	1.22
1999 total	733,070	40,366	16,998	5,821	5.51	2.32	0.79
April 2000	86,910	4,106	1,746	617	4.72	2.01	0.71
May 2000	183,400	14,718	5,944	1,748	8.03	3.24	0.95
June 2000	204,200	9,938	3,479	389	4.87	1.70	0.19
July 2000	50,240	2,044	794	196	4.07	1.58	0.39
August 2000	43,930	2,453	989	288	5.58	2.25	0.66
September 2000	46,850	6,783	2,784	871	14.48	5.94	1.86
2000 total	615,530	40,042	15,736	4,109	6.51	2.56	0.67
Annual means	674,300	40,204	16,367	4,965	6.01	2.44	0.73

* From Gandara et al. (2000) and Gandara, Gibbons, and Barbie (2001) for gauging station near Hempstead.

Table 50: Estimated effects of HSIR on the flow of the Brazos River in the Middle Basin; units are given in acre-feet except where marked as percentages.

Date	Qtot*	ΔQ_{high}	ΔQ_{middle}	ΔQ_{low}	$\Delta Q_{high}\%$	$\Delta Q_{mid}\%$	$\Delta Q_{low}\%$
April 1999	32,620	11,021	4,449	1,306	33.79	13.64	4.00
May 1999	10,700	25,187	8,626	706	235.39	80.62	6.60
June 1999	8,420	18,969	4,320	0	225.29	51.31	0.00
July 1999	26,160	3,220	960	0	12.31	3.67	0.00
August 1999	44,710	3,199	1,209	258	7.15	2.70	0.58
September 1999	1,980	9,323	3,607	874	470.86	182.17	44.14
1999 total	124,590	67,720	23,171	3,144	54.35	18.60	2.52
April 2000	9,790	20,259	8,553	2,954	206.94	87.36	30.17
May 2000	25,540	15,928	6,207	1,557	62.40	24.30	6.10
June 2000	96,570	20,094	6,127	0	20.81	6.34	0.00
July 2000	26,240	4,405	1,769	509	16.79	6.74	1.94
August 2000	44,070	0	0	0	0.00	0.00	0.00
September 2000	31,390	2,367	878	165	7.54	2.80	0.53
2000 total	233,600	63,053	23,534	5,185	26.99	10.07	2.22
Annual means	179,095	65,387	23,353	4,165	40.67	14.34	2.37

* From Gandara et al. (2000) and Gandara, Gibbons, and Barbie (2001) for gauging station at Waco.

Table 51: Estimated effects of HSIR on the flow of the Brazos River in the Upper Basin; units are given in acre-feet except where marked as percentages.

Date	Qtot*	ΔQhigh	ΔQmiddle	ΔQlow	ΔQhigh%	ΔQmid%	ΔQlow%
April 1999	37	1,080	501	225	2,918.92	1,354.05	608.11
May 1999	6,400	1,368	503	89	21.38	7.86	1.39
June 1999	75,210	1,529	587	137	2.03	0.78	0.18
July 1999	6,140	255	95	18	4.15	1.55	0.29
August 1999	2,040	308	123	35	15.10	6.03	1.72
September 1999	3,130	432	143	5	13.80	4.57	0.16
1999 total	92,957	4,972	1,952	509	5.35	2.10	0.55
April 2000	3,340	415	176	62	12.43	5.27	1.86
May 2000	2,880	439	187	66	15.24	6.49	2.29
June 2000	9,990	1,229	475	114	12.30	4.75	1.14
July 2000	3,230	459	164	24	14.21	5.08	0.74
August 2000	442	81	21	0	18.33	4.75	0.00
September 2000			0	0		0.00	0.00
2000 total	19,882.3	2,630	1,023	266	13.23	5.15	1.34
Annual means	56,420	2,486	1,488	388	9.29	3.63	0.95

From Gandara et al. (2000) and Gandara, Gibbons, and Barbie (2001) for gauging station near Aspermont.

Table 52: Estimated effects of HSIR on the flow of the Colorado River in the Lower Basin; units are given in acre-feet except where marked as percentages.

Date	Qtot*	ΔQhigh	ΔQmiddle	ΔQlow	ΔQhigh%	ΔQmid%	ΔQlow%
April 1999	97,930	5,859	2,788	1,218	5.98	2.85	1.24
May 1999	121,800	38,445	18,910	8,925	31.56	15.53	7.33
June 1999	152,900	23,073	11,327	5,323	15.09	7.41	3.48
July 1999	83,870	20,230	9,904	4,619	24.12	11.81	5.51
August 1999	44,530	941	262	0	2.11	0.59	0.00
September 1999	31,650	3,545	1,606	614	11.20	5.07	1.94
1999 total	532,680	92,093	44,797	20,699	17.29	8.41	3.89
April 2000	42,150	10,981	5,348	2,470	26.05	12.69	5.56
May 2000	90,230	25,089	12,232	5,660	27.81	13.56	6.27
June 2000	103,700	26,223	12,902	6,093	25.29	12.44	5.88
July 2000	58,510	6,895	3,229	1,357	11.78	5.52	2.32
August 2000	37,770	5,415	2,500	1,009	14.34	6.62	2.67
September 2000	40,530	9,314	4,490	2,025	22.98	11.08	5.00
2000 total	372,890	83,917	40,701	18,614	22.50	10.92	4.99
Annual means	452,785	88,005	42,749	19,657	19.90	9.67	4.44

From Gandara et al. (2000) and Gandara, Gibbons, and Barbie (2001) for gauging station at Wharton.

Table 53: Estimated effects of HSIR on the flow of the Colorado River in the Middle Basin; units are given in acre-feet except where marked as percentages.

Date	Qtot*	ΔQhigh	ΔQmiddle	ΔQlow	ΔQhigh%	ΔQmid%	ΔQlow%
April 1999	64,260	21,006	7,283	720	32.69	11.22	1.12
May 1999	99,870	75,145	26,756	3,613	75.24	26.79	3.62
June 1999	96,720	27,599	10,170	1,835	28.53	10.51	1.90
July 1999	76,710	18,556	6,006	4	24.19	7.83	0.01
August 1999	62,610	2,565	0	0	4.10	0.00	0.00
September 1999	51,840	5,266	1,840	202	10.16	3.55	0.04
1999 total	452,010	150,137	52,055	6,374	33.22	11.52	1.41
April 2000	55,420	27,989	10,821	2,611	50.50	19.53	4.71
May 2000	92,840	33,283	9,142	0	35.85	9.85	0.00
June 2000	101,400	41,013	10,279	0	40.45	10.14	0.00
July 2000	122,000	12,798	4,724	862	10.49	3.87	0.71
August 2000	82,840	74	0	0	0.08	0.00	0.00
September 2000	89,960	29,536	11,944	3,530	32.83	13.28	3.92
2000 total	544,460	144,693	46,910	7,003	26.58	8.62	1.29
Annual means	498,235	147,415	49,483	4,807	29.90	10.07	1.35

* From Gandara et al. (2000) and Gandara, Gibbons, and Barbie (2001) for gauging station at Austin.

Table 54: Estimated effects of HSIR on the flow of the Colorado River in the Upper Basin; units are given in acre-feet except where marked as percentages.

Date	Qtot*	ΔQhigh	ΔQmiddle	ΔQlow	ΔQhigh%	ΔQmid%	ΔQlow%
April 1999	785	3,066	1,126	198	390.57	143.44	25.22
May 1999	1,040	2,635	0	0	253.37	0.00	0.00
June 1999	1,380	4,491	273	0	325.43	19.78	0.00
July 1999	1,610	0	0	0	0.00	0.00	0.00
August 1999	1,830	554	0	0	30.27	0.00	0.00
September 1999	1,170	1,692	125	0	144.62	10.68	0.00
1999 total	7,030	12,438	1,524	198	175.93	21.68	2.82
April 2000	698	527	0	0	75.50	0.00	0.00
May 2000	986	1,499	0	0	152.03	0.00	0.00
June 2000	5,840	4,034	0	0	69.08	0.00	0.00
July 2000	732	0	0	0	0.00	0.00	0.00
August 2000	682	282	0	0	41.35	0.00	0.00
September 2000	704	73	0	0	10.37	0.00	0.00
2000 total	9,642	6,415	0	0	66.53	0.00	0.00
Annual means	8,336	9,427	762	99	121.23	10.84	1.41

* From Gandara et al. (2000) and Gandara, Gibbons, and Barbie (2001) for gauging station near Stacy.

Table 55: Estimated effects of HSIR on the flow of the Guadalupe River in the Lower Basin; units are given in acre-feet except where marked as percentages.

Date	Qtot*	ΔQhigh	ΔQmiddle	ΔQlow	ΔQhigh%	ΔQmid%	ΔQlow%
April 1999	77,790	25,622	12,164	5,286	32.94	15.64	6.80
May 1999	90,680	190,232	89,419	37,893	209.78	98.61	41.79
June 1999	115,600	163,592	78,740	35,371	141.52	68.11	30.60
July 1999	69,140	75,867	36,942	17,047	109.73	53.43	24.66
August 1999	43,880	27,755	12,931	5,353	63.25	29.47	12.20
September 1999	31,620	35,340	16,867	7,469	111.76	53.34	23.62
1999 total	428,710	518,408	247,063	108,419	120.92	57.63	25.29
April 2000	37,860	42,358	23,500	13,859	111.88	62.07	36.61
May 2000	54,900	151,248	71,387	30,569	275.50	130.03	55.68
June 2000	87,770	144,891	64,806	23,873	165.08	73.84	27.20
July 2000	26,110	28,335	13,176	5,428	108.52	50.46	20.79
August 2000	17,800	28,862	13,483	5,623	162.15	75.75	31.59
September 2000	16,180	51,199	24,652	11,083	316.43	152.36	68.50
2000 total	240,550	446,893	211,004	90,435	185.78	87.72	37.60
Annual means	334,630	482,651	229,034	99,427	153.35	72.68	31.45

* From Gandara et al. (2000) and Gandara, Gibbons, and Barbie (2001) for gauging station at Victoria.

Table 56: Estimated effects of HSIR on the flow of the Guadalupe River in the Upper Basin; units are given in acre-feet except where marked as percentages.

Date	Qtot*	ΔQhigh	ΔQmiddle	ΔQlow	ΔQmax%	ΔQmid%	ΔQlow%
April 1999	14,350	27,496	13,437	6,251	191.61	93.64	43.56
May 1999	13,130	48,116	23,616	11,093	366.46	179.86	84.49
June 1999	16,440	45,589	22,315	10,419	277.31	135.74	63.38
July 1999	21,770	26,633	12,851	7,164	122.34	59.03	32.91
August 1999	9,820	9,248	4,155	1,552	94.18	42.31	15.80
September 1999	6,320	9,464	4,370	1,767	149.75	69.15	27.96
1999 total	81,830	166,546	80,744	38,246	203.53	98.67	46.74
April 2000	5,520	21,604	10,491	4,811	391.38	190.05	87.16
May 2000	5,410	58,553	28,834	13,644	1,060.74	522.36	247.17
June 2000	9,710	14,125	6,583	2,728	145.47	67.80	28.09
July 2000	4,180	17,234	8,152	3,510	412.30	195.02	83.97
August 2000	2,920	5,801	2,432	709	198.66	83.29	24.28
September 2000	2,550	38,005	18,424	8,416	1,490.39	722.51	330.05
2000 total	30,290	155,322	74,916	33,818	512.78	247.33	111.65
Annual means	56,060	160,934	77,830	36,032	358.16	173.00	79.20

* From Gandara et al. (2000) and Gandara, Gibbons, and Barbie (2001) for gauging station above Comal River at New Braunfels.

Table 57: Estimated effects of HSIR on the flow of the Nueces River in the Lower Basin; units are given in acre-feet except where marked as percentages.

Date	Qtot*	ΔQhigh	ΔQmiddle	ΔQlow	ΔQhigh%	ΔQmid%	ΔQlow%
April 1999	22,230	2,349	0	0	10.57	0.00	0.00
May 1999	15,320	7,234	2,405	95	47.22	15.70	0.62
June 1999	25,440	10,890	3,179	0	42.81	12.50	0.00
July 1999	30,890	5,886	2,085	267	19.05	6.75	0.86
August 1999	12,520	6,976	2,611	523	55.72	20.85	4.18
September 1999	64,920	1,901	737	180	2.93	1.14	0.28
1999 total	171,320	35,236	11,017	1,065	20.57	6.43	0.62
April 2000	2,380	2,438	827	57	102.44	34.75	2.39
May 2000	5,890	5,642	1,249	0	95.79	21.21	0.00
June 2000	30,780	9,173	3,208	355	29.80	10.42	1.15
July 2000	2,180	1,118	150	0	51.28	6.88	0.00
August 2000	2,010	1,332	401	0	66.27	19.95	0.00
September 2000	1,990	4,268	1,894	759	214.47	95.18	38.14
2000 total	45,230	23,971	7,729	1,171	53.00	17.09	2.59
Annual means	108,275	29,604	9,373	1,118	36.79	11.76	1.61

* From Gandara et al.. (2000) and Gandara, Gibbons, and Barbie (2001) for gauging station near Three Rivers.

Table 58: Estimated effects of HSIR on the flow of the Nueces River in the Upper Basin; units are given in acre-feet except where marked as percentages.

Date	Qtot*	ΔQhigh	ΔQmiddle	ΔQlow	ΔQhigh%	ΔQmid%	ΔQlow%
April 1999	11,380	7,211	3,489	1,589	63.37	30.66	13.96
May 1999	14,070	4,170	2,011	908	29.64	14.29	6.45
June 1999	14,400	5,701	2,770	1,272	39.59	19.24	8.83
July 1999	13,630	3,478	1,663	735	25.52	12.20	5.39
August 1999	5,550	877	362	100	15.80	6.52	1.80
September 1999	3,320	1,338	598	220	40.30	18.01	6.63
1999 total	62,350	22,775	10,893	4,824	36.53	17.47	7.74
April 2000	1,240	3,565	1,734	799	287.50	139.84	64.44
May 2000	1,010	3,975	1,914	860	393.56	189.50	85.15
June 2000	877	7,253	3,546	1,652	827.02	404.33	188.37
July 2000	641	2,873	1,360	587	448.21	212.17	91.58
August 2000	507	588	218	29	115.98	43.00	5.72
September 2000	413	4,664	2,261	1,033	1,129.30	547.46	250.12
2000 total	4,688	22,918	11,033	4,960	488.87	235.35	105.80
Annual means	33,519	22,947	10,963	4,892	262.70	126.41	56.77

* From Gandara et al.. (2000) and Gandara, Gibbons, and Barbie (2001) for gauging station below Uvalde.

Table 59: Estimated effects of HSIR on the flow of the Trinity River in the Lower Basin; units are given in acre-feet except where marked as percentages.

Date	Qtot*	ΔQhigh	ΔQmiddle	ΔQlow	ΔQhigh%	ΔQmid%	ΔQlow%
April 1999	389,100	19,139	8,607	3,571	4.92	2.21	0.92
May 1999	267,700	91,072	37,664	12,122	34.26	14.07	4.53
June 1999	604,000	66,917	29,011	10,882	11.08	4.80	1.80
July 1999	194,700	50,061	23,358	10,587	25.71	12.00	5.44
August 1999	79,470	8,710	3,144	481	10.96	3.96	0.61
September 1999	44,720	32,271	14,909	6,605	72.16	33.33	14.77
1999 total	1,579,690	268,170	116,693	44,248	16.98	7.39	2.80
April 2000	238,600	23,075	9,633	3,204	9.67	4.04	1.34
May 2000	363,200	83,563	32,278	7,751	23.01	8.89	2.13
June 2000	650,400	75,813	31,277	9,976	11.66	4.81	1.53
July 2000	168,300	15,950	6,681	2,249	9.48	3.97	1.34
August 2000	64,970	15,607	6,515	2,167	24.02	10.03	3.34
September 2000	63,710	47,370	22,290	10,296	74.35	34.99	16.16
2000 total	1,549,180	261,378	108,674	35,643	16.87	7.01	2.30
Annual means	1,564,435	264,774	112,684	39,646	16.93	7.20	2.55

* From Gandara et al.. (2000) and Gandara, Gibbons, and Barbie (2001) for gauging station near Goodrich.

Table 60: Estimated effects of HSIR on the flow of the Trinity River in the Upper Basin; units are given in acre-feet except where marked as percentages.

Date	Qtot*	ΔQhigh	ΔQmiddle	ΔQlow	ΔQhigh%	ΔQmid%	ΔQlow%
April 1999	113,900	2,221	576	0	1.95	0.51	0.00
May 1999	299,500	12,882	4,470	447	4.30	1.49	0.15
June 1999	197,800	4,028	1,403	148	2.04	0.71	0.07
July 1999	86,250	1,209	235	0	1.40	0.27	0.00
August 1999	51,410	686	222	0	1.33	0.42	0.00
September 1999	60,050	4,293	1,811	623	7.15	3.02	1.04
1999 total	808,910	25,319	8,717	1,218	3.13	1.08	0.15
April 2000	108,800	6,858	2,716	734	6.30	2.50	0.67
May 2000	145,000	5,356	1,633	0	3.69	1.13	0.00
June 2000	483,400	6,785	1,800	0	1.40	0.37	0.00
July 2000	58,110	1,119	436	109	1.93	0.75	0.19
August 2000	36,430	0	0	0	0.00	0.00	0.00
September 2000	39,510	1,234	468	101	3.12	1.18	0.26
2000 total	871,250	21,352	7,053	944	2.45	0.81	0.11
Annual means	840,080	23,336	7,885	1,081	2.79	0.95	0.13

From Gandara et al.. (2000) and Gandara, Gibbons, and Barbie (2001) for gauging station near Rosser.

Figure 17 plots the annual means for each of the above tables, with the basins ordered from highest to lowest Q_{tot} . Not surprisingly, precipitation declines with Q_{tot} . The rest of the values show considerable variation, but follow general trends. The ΔQ values have the greatest variation but generally decline with Q_{tot} . The $\Delta Q\%$ values follow an inverse and less variable trend, increasing as Q_{tot} decreases. These results are hydrologically reasonable. As streams decrease in discharge, the magnitude of variation in discharge also decreases. Meanwhile, the more frequent and smaller storm events have proportionally greater impacts. No correlations are observed between basin size with Q_{tot} , or ΔQ .

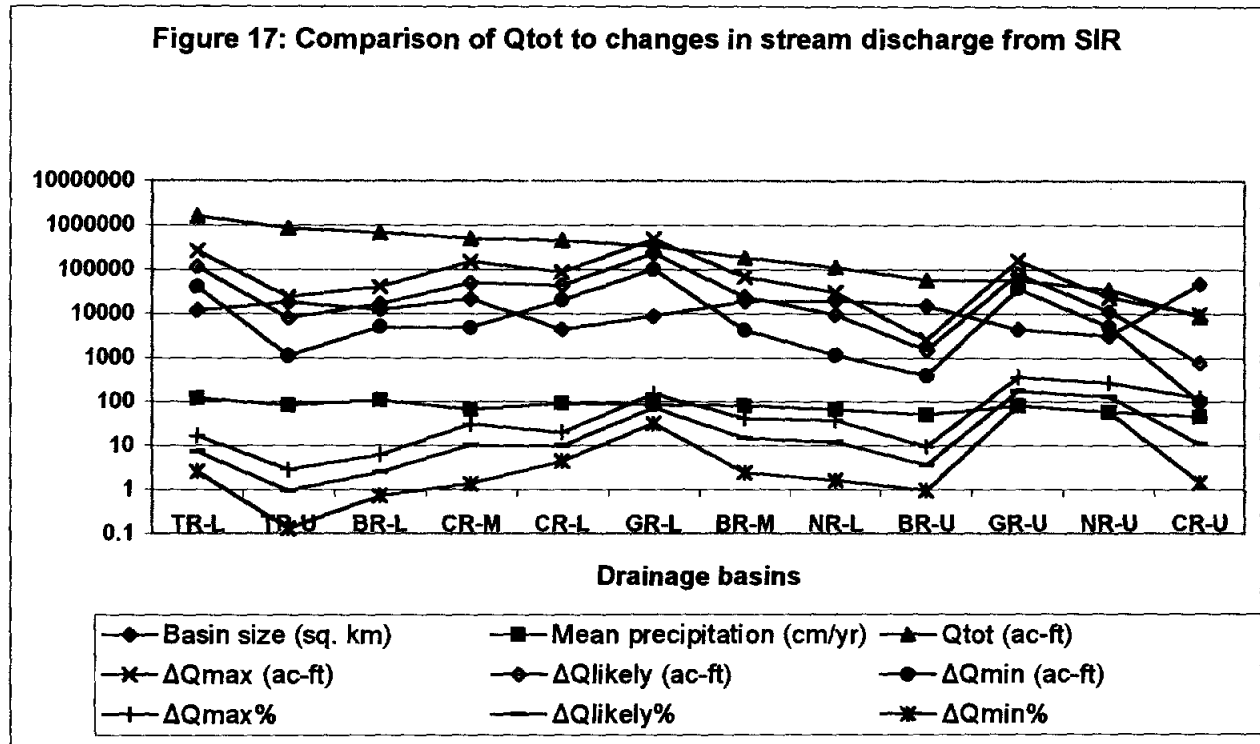

The Upper Basin of the Nueces River and the Upper and Lower basins of the Guadalupe River exhibit the greatest proportional changes in discharge. Located along and just downstream of the steep slopes of the Balcones Escarpment area, these relatively small streams experience some of the greatest flooding in Texas as water rapidly runs down the hillsides with little loss to ET or the thin to absent soils. The above basins plus the Lower Trinity, Middle Colorado, Middle Brazos, and Lower Nueces River basins exhibit relatively large volumetric gains in discharge. This is advantageous in some areas, such the Middle Colorado where the water can feed the Highland Lakes that are used as major water supplies for that region, but it could prove disastrous in the Lower Trinity which is prone to major catastrophic flooding. The least effect by HSIR occurs in the Upper Colorado and Upper Brazos River basins that show little proportional gain by HSIR and relatively little volumetric gain. This is due to the low-gradient semi-arid topography that captures relatively large volumes of water before it reaches the streams.

As found in the examination of effective precipitation throughout the drainage basins, hypothetical HSIR during August generally produces the smallest effect on stream discharge

both proportionally and volumetrically, followed by July and September. Notable gains in discharge do occur in the Lower Colorado, the Upper and Lower Guadalupe, and the Lower Trinity River basins. HSIR during these months is still lower than the other months in these basins, but potentially worthwhile if warranted by conditions and regional needs.

13.3.5 Aquifer recharge calculations

Tables 61-85 provide the monthly and annual NSR values and the maximum, likely, and minimum hypothetical HSIR for the 25-aquifer recharge zones for 1999 and 2000. They also include ΔR , the volumetric difference in recharge between NSR and HSIR as calculated by equation 2. ΔR_{max} is the maximum calculated difference, ΔR_{likely} is the most likely calculated difference, and ΔR_{min} is the minimum calculated difference. The annual totals and means are for the 6-month periods of record and not 12-month calendar years.

Table 61: Estimated potential effects of HSIR on recharge of the Hueco-Mesilla Bolson Segment of the Alluvium and Bolson aquifer; R = 2.1% per Table 24; all units below are given in acre-feet.

Date	NSR	HSIR high	HSIR middle	HSIR low	ΔR high	ΔR middle	ΔR low
April 1999	4,227	8,031	6,129	5,157	76	36	15
May 1999	10,084	19,161	14,623	12,303	191	95	47
June 1999	22,397	42,554	32,475	27,324	423	212	103
July 1999	56,161	106,705	81,433	68,516	1,061	531	259
August 1999	43,788	83,198	63,493	53,422	828	414	202
September 1999	14,091	26,772	20,431	17,190	266	133	65
1999 total	146,521	278,389	212,455	178,755	2,845	1,456	691
April 2000	281	534	408	343	5	3	1
May 2000	1,073	2,039	1,556	1,310	20	10	5
June 2000	42,379	80,521	61,450	51,703	801	400	196
July 2000	31,873	60,559	46,216	38,885	602	301	147
August 2000	19,848	37,711	28,779	24,214	375	188	92
September 2000	1,755	3,334	2,544	2,141	33	17	8
2000 total	97,209	184,698	140,954	118,595	1,836	919	449
Annual means	121,865	231,543	176,705	148,675	2,341	1,188	570

Table 62: Estimated potential effects of HSIR on recharge of the Rio Grande to Nueces River Segment of the Carrizo-Wilcox Aquifer; R = 5.3% per Table 24; all units below are given in acre-feet.

Date	NSR	HSIR high	HSIR middle	HSIR low	ΔR high	ΔR middle	ΔR low
April 1999	27,869	52,950	40,409	34,000	1,329	665	325
May 1999	67,965	129,133	98,549	82,917	3,242	1,621	792
June 1999	97,510	185,269	141,389	118,962	4,651	2,326	1,137
July 1999	42,968	81,640	62,304	52,422	2,050	1,025	501
August 1999	59,658	113,350	86,504	72,783	2,846	1,423	696
September 1999	8,668	16,469	12,568	10,575	413	201	101
1999 total	304,638	578,812	441,725	371,658	14,531	7,261	3,522
April 2000	10,651	20,237	15,444	12,995	508	254	124
May 2000	36,892	70,094	53,493	45,008	1,760	880	430
June 2000	66,279	125,931	96,105	80,861	3,162	1,581	773
July 2000	11,296	21,463	16,379	13,781	539	269	132
August 2000	3,581	6,804	5,192	4,369	171	85	42
September 2000	27,413	52,085	39,749	33,444	1,308	654	320
2000 total	156,112	296,613	226,362	190,457	7,448	3,723	1,821
Annual means	230,375	437,713	334,044	281,058	10,990	5,492	2,687

Table 63: Estimated potential effects of HSIR on recharge of the Nueces River to Guadalupe River Segment of the Carrizo-Wilcox Aquifer; R = 8% per Table 24; all units below are given in acre-feet.

Date	NSR	HSIR high	HSIR middle	HSIR low	ΔR high	ΔR middle	ΔR low
April 1999	14,785	28,092	21,438	18,038	1,065	532	260
May 1999	23,816	45,250	34,533	29,055	1,715	857	419
June 1999	36,277	68,926	52,602	44,258	2,612	1,306	638
July 1999	16,523	31,393	23,958	20,158	1,190	595	291
August 1999	8,320	15,808	12,064	10,150	599	300	146
September 1999	7,010	13,319	10,164	8,552	505	252	123
1999 total	106,730	202,788	154,759	130,211	7,686	3,842	1,877
April 2000	12,209	23,198	17,704	14,895	879	440	215
May 2000	22,408	42,576	32,492	27,338	1,613	807	394
June 2000	29,003	55,106	42,054	35,384	2,088	1,044	510
July 2000	4,791	9,103	6,947	5,845	345	172	84
August 2000	5,125	9,737	7,431	6,252	369	184	90
September 2000	13,173	25,029	19,101	16,071	948	474	232
2000 total	86,710	164,749	125,729	105,786	6,242	3,121	1,525
Annual means	96,720	183,769	140,244	117,999	6,964	3,482	1,701

Table 64: Estimated potential effects of HSIR on recharge of the Guadalupe River to Colorado River Segment of the Carrizo-Wilcox Aquifer; R = 5% per Table 24; all units below are given in acre-feet.

Date	NSR	HSIR high	HSIR middle	HSIR low	ΔR high	ΔR middle	ΔR low
April 1999	14,353	27,270	27,270	20,812	646	646	329
May 1999	87,085	165,462	165,462	126,274	3,919	3,919	1,959
June 1999	44,080	83,751	83,751	63,916	1,984	1,984	992
July 1999	35,339	67,145	67,145	51,242	1,590	1,590	795
August 1999	4,318	8,203	8,203	6,260	194	194	97
September 1999	6,133	11,652	11,652	8,893	276	276	138
1999 total	191,308	363,484	363,484	277,396	8,609	8,609	4,310
April 2000	23,932	45,470	45,470	34,701	1,077	1,077	538
May 2000	58,886	111,884	111,884	85,385	2,650	2,650	1,325
June 2000	47,491	90,233	90,233	68,862	2,137	2,137	1,069
July 2000	6,532	12,411	12,411	9,472	294	294	147
August 2000	10,714	20,356	20,356	15,535	482	482	241
September 2000	21,735	41,297	41,297	31,516	978	978	489
2000 total	169,290	321,652	321,652	245,471	6,541	6,541	3,809
Annual means	180,299	342,568	342,568	261,434	7,575	7,575	4,060

Table 65: Estimated potential effects of HSIR on recharge of the Colorado River to Brazos River Segment of the Carrizo-Wilcox Aquifer; R = 5% per Table 24; all units below are given in acre-feet.

Date	NSR	HSIR high	HSIR middle	HSIR low	ΔR high	ΔR middle	ΔR low
April 1999	44,678	84,888	64,783	54,507	2,011	1,005	491
May 1999	242,393	460,546	351,470	295,719	10,908	5,454	2,666
June 1999	108,503	206,157	157,330	132,374	4,883	2,441	1,194
July 1999	107,101	203,493	155,297	130,664	4,820	2,411	1,178
August 1999	12,065	22,924	17,495	14,720	543	272	133
September 1999	25,679	48,790	37,234	31,328	1,156	578	282
1999 total	540,420	1,026,798	783,609	659,313	24,321	12,161	5,944
April 2000	75,302	143,074	109,188	91,869	3,389	1,694	828
May 2000	212,211	403,200	307,706	258,897	9,549	4,775	2,334
June 2000	155,617	295,672	225,645	189,853	7,003	3,501	1,712
July 2000	48,693	92,517	70,605	59,406	2,191	1,096	536
August 2000	24,342	46,249	35,296	29,697	1,095	548	268
September 2000	108,214	205,607	156,910	132,021	4,870	2,435	1,190
2000 total	624,379	1,186,320	905,350	761,742	28,097	14,049	6,868
Annual means	582,400	1,106,559	844,480	710,528	26,209	13,105	6,406

Table 66: Estimated potential effects of HSIR on recharge of the Brazos River to Trinity River Segment of the Carrizo-Wilcox Aquifer; R = 5% per Table 24; all units below are given in acre-feet.

Date	NSR	HSIR high	HSIR middle	HSIR low	ΔR high	ΔR middle	ΔR low
April 1999	83,697	159,024	121,360	102,110	3,766	1,883	921
May 1999	331,193	629,266	480,229	404,055	14,904	7,452	3,643
June 1999	186,363	354,090	270,227	227,363	8,386	4,193	2,050
July 1999	110,948	210,801	160,874	135,356	4,993	2,496	1,220
August 1999	29,511	56,071	42,791	36,004	1,328	664	325
September 1999	100,840	191,596	146,218	123,025	4,538	2,269	1,109
1999 total	842,552	1,600,848	1,221,700	1,027,913	37,915	18,957	8,347
April 2000	140,026	266,050	203,038	170,832	6,301	3,151	1,540
May 2000	380,596	723,132	551,864	464,327	17,127	8,563	4,187
June 2000	318,099	604,388	461,243	388,081	14,314	7,157	3,499
July 2000	6,339	12,043	9,191	7,733	285	143	70
August 2000	29,428	55,913	42,671	35,902	1,324	662	324
September 2000	135,500	257,450	196,475	165,310	6,098	3,049	1,491
2000 total	1,009,987	1,918,976	1,464,482	1,232,185	45,449	22,725	11,111
Annual means	926,270	1,759,912	1,343,091	1,131,049	41,682	20,841	9,729

Table 67: Estimated potential effects of HSIR on recharge of the Trinity River to Sulfur River Segment of the Carrizo-Wilcox Aquifer; R = 4% per Table 24; all units below are given in acre-feet.

Date	NSR	HSIR high	HSIR middle	HSIR low	ΔR high	ΔR middle	ΔR low
April 1999	181,893	345,596	263,745	221,909	6,548	3,274	1,601
May 1999	1,061,128	2,016,144	1,538,636	1,294,577	38,201	19,100	9,338
June 1999	387,804	736,828	562,316	473,121	13,961	6,980	3,413
July 1999	160,898	305,706	233,302	196,295	5,792	2,896	1,416
August 1999	47,890	90,992	69,441	58,426	1,724	862	421
September 1999	296,988	564,278	430,633	362,326	10,692	5,346	2,614
1999 total	2,136,602	4,059,543	3,098,073	2,606,654	76,918	38,458	17,202
April 2000	402,449	764,653	583,551	490,988	14,488	7,244	3,542
May 2000	730,643	1,388,221	1,059,432	891,384	26,303	13,152	6,430
June 2000	1,090,202	2,071,384	1,580,793	1,330,046	39,247	19,624	9,594
July 2000	42,502	80,753	61,627	51,852	1,530	765	374
August 2000	29,964	56,932	43,448	36,557	1,079	539	264
September 2000	173,047	328,790	250,919	211,118	6,230	3,115	1,523
2000 total	2,468,807	4,690,733	3,579,770	3,011,945	88,877	44,439	21,727
Annual means	2,302,705	4,375,138	3,338,922	2,809,300	82,898	41,449	19,465

Table 68: Estimated potential effects of HSIR on recharge of the Eastern Segment of the Carrizo-Wilcox Aquifer; R = 4% per Table 24; all units below are given in acre-feet.

Date	NSR	HSIR high	HSIR middle	HSIR low	ΔR high	ΔR middle	ΔR low
April 1999	80,223	152,424	116,323	97,872	2,888	1,444	706
May 1999	526,677	1,000,686	763,681	642,545	18,960	9,480	4,635
June 1999	269,906	512,821	391,363	329,285	9,717	4,869	2,375
July 1999	161,792	307,405	234,599	197,386	5,825	2,912	1,424
August 1999	22,740	43,206	32,973	27,743	819	409	200
September 1999	162,987	309,675	236,331	198,844	2,934	2,934	1,434
1999 total	1,224,324	2,326,216	1,775,270	1,493,676	41,143	22,048	10,774
April 2000	206,674	392,680	299,677	252,142	7,440	3,720	1,819
May 2000	425,005	807,509	616,257	518,506	15,300	7,650	3,740
June 2000	260,905	495,719	378,312	318,304	9,393	4,696	2,296
July 2000	40,017	76,032	58,024	48,820	1,441	720	352
August 2000	46,127	87,641	66,884	56,275	1,661	830	406
September 2000	96,172	182,727	139,450	117,330	2,002	5,464	3,733
2000 total	1,074,900	2,042,309	1,558,604	1,311,377	37,237	23,080	12,347
Annual means	1,149,612	2,184,263	1,666,937	1,402,527	39,190	22,564	11,561

Table 69: Estimated potential effects of HSIR on recharge of the San Antonio Segment of the Edwards (Balcones Fault Zone) Aquifer; R = 15.7% per Table 24; all units below are given in acre-feet.

Date	NSR	HSIR high	HSIR middle	HSIR low	ΔR high	ΔR middle	ΔR low
April 1999	205,630	390,697	298,164	250,869	29,056	14,528	7,103
May 1999	169,881	322,774	246,328	207,255	24,004	12,002	5,868
June 1999	321,025	609,947	465,486	391,650	45,361	22,680	11,088
July 1999	210,145	399,275	304,710	256,377	29,693	14,847	7,258
August 1999	47,432	90,121	68,777	57,867	6,702	3,351	1,638
September 1999	66,291	125,953	96,122	80,875	9,367	4,683	2,290
1999 total	1,020,405	1,938,769	1,479,587	1,244,894	144,183	72,091	35,245
April 2000	1,041,356	1,978,577	1,509,967	1,270,455	150,433	76,861	39,258
May 2000	235,887	448,186	342,036	287,782	33,331	16,665	8,148
June 2000	320,721	609,370	465,046	391,280	45,318	22,659	11,078
July 2000	124,764	237,052	180,908	152,212	17,629	8,815	4,309
August 2000	30,793	58,508	44,651	37,568	4,351	2,176	1,064
September 2000	178,291	338,752	258,522	217,515	25,192	12,596	6,158
2000 total	1,931,813	3,670,445	2,801,129	2,356,812	276,254	139,772	70,015
Annual means	1,476,109	2,804,607	2,140,358	1,800,853	210,219	105,932	52,630

Table 70: Estimated potential effects of HSIR on recharge of the Barton Springs Segment of the Edwards (Balcones Fault Zone) Aquifer; R = 21.7% per Table 24; all units below are given in acre-feet.

Date	NSR	HSIR high	HSIR middle	HSIR low	ΔR high	ΔR middle	ΔR low
April 1999	8,103	15,395	15,395	11,749	1,582	1,582	791
May 1999	32,617	61,973	61,973	47,295	6,370	6,370	3,185
June 1999	22,184	42,150	42,150	32,167	4,333	4,333	2,166
July 1999	20,797	39,514	39,514	30,155	4,062	4,062	2,031
August 1999	914	1,736	1,736	1,325	178	178	89
September 1999	3,084	5,860	5,860	4,472	602	602	301
1999 total	87,699	166,627	166,627	127,163	17,127	17,127	7,772
April 2000	13,199	25,078	25,078	19,139	2,578	2,578	1,289
May 2000	15,580	29,602	29,602	22,591	3,043	3,043	1,521
June 2000	35,492	67,436	67,436	51,464	6,932	6,932	3,466
July 2000	5,724	10,876	10,876	8,300	1,118	1,118	559
August 2000	2,100	3,989	3,989	3,044	410	410	205
September 2000	8,422	16,002	16,002	12,212	1,645	1,645	822
2000 total	80,517	152,983	152,983	116,750	15,726	15,726	7,862
Annual means	84,108	159,805	163,216	121,957	16,427	16,427	7,817

Table 71: Estimated potential effects of HSIR on recharge of the Northern Segment of the Edwards (Balcones Fault Zone) Aquifer; R = 19.3% per Table 24; all units below are given in acre-feet.

Date	NSR	HSIR high	HSIR middle	HSIR low	ΔR high	ΔR middle	ΔR low
April 1999	29,113	55,314	42,213	35,517	5,057	2,528	1,236
May 1999	149,006	283,112	216,059	181,787	25,882	6,213	6,327
June 1999	50,200	95,379	72,789	61,244	8,720	4,360	2,131
July 1999	70,386	133,733	102,060	85,871	12,226	6,113	2,989
August 1999	1,787	3,395	2,591	2,180	310	155	76
September 1999	6,245	11,865	9,055	7,619	1,085	542	265
1999 total	306,736	582,799	444,768	374,218	53,280	19,911	13,024
April 2000	36,371	69,105	52,738	44,372	6,318	3,159	1,544
May 2000	74,459	141,472	107,965	90,840	12,934	6,467	3,162
June 2000	104,999	199,498	152,249	128,099	18,238	9,119	4,458
July 2000	20,122	38,232	29,177	24,549	3,495	1,748	854
August 2000	7,633	14,503	11,068	9,313	1,326	663	324
September 2000	25,723	48,873	37,298	31,382	4,468	2,234	1,092
2000 total	269,307	511,683	390,495	328,554	46,779	23,390	11,434
Annual means	288,022	547,241	417,632	351,386	50,030	21,651	12,229

Table 72: Estimated potential effects of HSIR on recharge of the Central Segment of the Edwards-Trinity Aquifer; R = 2.1% per Table 24; all units below are given in acre-feet.

Date	NSR	HSIR high	HSIR middle	HSIR low	ΔR high	ΔR middle	ΔR low
April 1999	296,681	430,187	361,951	329,316	2,804	1,371	685
May 1999	394,126	571,483	480,834	437,480	3,724	1,821	910
June 1999	313,007	453,860	381,868	347,438	2,958	1,446	723
July 1999	138,084	200,221	168,462	153,273	1,305	638	319
August 1999	54,260	78,678	66,198	60,229	513	251	125
September 1999	74,063	107,391	90,356	82,209	700	342	171
1999 total	1,270,221	1,841,821	1,549,670	1,409,945	12,004	5,869	2,933
April 2000	375,466	544,426	458,069	416,768	3,548	1,735	867
May 2000	252,399	365,978	307,926	280,163	2,385	1,166	583
7June 2000	625,352	906,760	762,929	694,141	5,910	2,889	1,445
July 2000	90,660	131,458	110,606	100,633	857	419	209
August 2000	10,815	15,682	13,195	12,005	102	50	25
September 2000	255,944	371,119	312,252	284,098	2,419	1,182	591
2000 total	1,610,637	2,335,424	1,964,977	1,787,807	15,221	7,441	2,420
Annual means	1,440,429	2,088,623	1,757,324	1,598,876	13,613	6,655	2,677

Table 73: Estimated potential effects of HSIR on recharge of the Stockton Plateau Segment of the Edwards-Trinity Aquifer; R = 2.5% per Table 24; all units below are given in acre-feet.

Date	NSR	HSIR high	HSIR middle	HSIR low	ΔR high	ΔR middle	ΔR low
April 1999	81,846	155,507	118,676	99,852	1,842	921	450
May 1999	344,769	655,061	499,915	420,618	7,757	3,879	1,896
June 1999	194,079	368,749	281,414	236,776	4,367	2,183	1,067
July 1999	83,611	158,861	121,236	102,006	1,881	941	460
August 1999	5,966	11,336	8,651	7,279	134	67	33
September 1999	31,390	59,641	45,516	38,296	706	353	173
1999 total	741,661	1,409,156	1,075,409	904,827	16,687	8,344	4,079
April 2000	48,261	91,696	69,978	58,878	1,086	543	265
May 2000	49,438	93,932	71,685	60,314	1,112	556	272
June 2000	291,174	553,230	422,202	355,232	6,551	3,276	1,601
July 2000	50,413	95,785	73,099	61,504	1,134	567	277
August 2000	18,089	34,369	26,229	22,069	407	204	100
September 2000	105,711	200,851	153,281	128,968	2,379	1,189	581
2000 total	563,086	1,069,863	816,474	686,965	12,669	6,335	3,096
Annual means	652,374	1,239,510	945,942	795,896	14,678	7,340	3,588

Table 74: Estimated potential effects of HSIR on recharge of the Trans-Pecos Segment of the Edwards-Trinity Aquifer; R = 2.5% per Table 24; all units below are given in acre-feet.

Date	NSR	HSIR high	HSIR middle	HSIR low	ΔR high	ΔR middle	ΔR low
April 1999	8,734	16,594	12,664	10,655	197	98	48
May 1999	89,443	169,941	129,692	109,120	2,012	1,006	492
June 1999	108,973	207,049	158,011	132,947	2,452	1,226	599
July 1999	49,930	94,867	72,398	60,915	1,123	562	275
August 1999	3,665	6,963	5,314	4,471	82	41	20
September 1999	27,777	52,776	40,277	33,888	625	313	153
1999 total	288,521	548,190	418,356	351,996	6,491	3,246	1,587
April 2000	10,830	20,576	15,703	13,212	244	122	60
May 2000	18,197	34,575	26,386	22,201	409	204	100
June 2000	133,163	253,009	193,086	162,458	2,996	1,498	732
July 2000	21,308	40,485	30,896	25,996	479	240	117
August 2000	16,838	31,993	24,416	20,543	379	189	93
September 2000	2,051	3,898	2,975	2,503	46	23	11
2000 total	202,387	384,536	293,462	246,913	4,553	2,276	1,113
Annual means	245,454	466,363	355,909	299,455	5,522	2,761	1,350

Table 75: Estimated potential effects of HSIR on recharge of the Rio Grande to Nueces River Segment of the Gulf Coast Aquifer; R = 2% per Table 24; all units below are given in acre-feet.

Date	NSR	HSIR high	HSIR middle	HSIR low	ΔR high	ΔR middle	ΔR low
April 1999	80,534	116,775	98,252	89,393	725	354	177
May 1999	764,029	1,107,841	932,115	848,072	6,876	3,362	1,681
June 1999	868,590	1,259,455	1,059,679	964,134	7,817	3,822	1,911
July 1999	733,293	1,063,275	894,618	813,956	6,600	3,227	1,613
August 1999	864,691	1,253,803	1,054,923	959,807	7,782	3,805	1,902
September 1999	687,989	997,584	839,346	763,667	6,192	3,027	1,514
1999 total	3,999,126	5,798,732	4,878,933	4,439,030	35,992	17,597	8,798
April 2000	233,473	338,536	284,837	259,155	2,101	1,027	454
May 2000	1,407,317	2,040,610	1,716,927	1,562,122	12,666	6,192	3,096
June 2000	583,147	845,563	711,439	647,293	5,248	2,566	1,283
July 2000	146,323	212,169	178,514	162,419	1,317	644	322
August 2000	314,810	456,474	384,068	349,439	2,833	1,385	693
September 2000	285,121	413,426	347,848	316,484	2,566	1,255	627
2000 total	2,970,191	4,306,776	3,623,633	3,296,912	26,731	13,069	6,475
Annual means	3,484,659	5,052,754	4,251,283	3,867,971	31,362	15,333	7,367

Table 76: Estimated potential effects of HSIR on recharge of the Nueces River to Brazos River Segment of the Gulf Coast Aquifer; R = 2% per Table 24; all units below are given in acre-feet.

Date	NSR	HSIR high	HSIR middle	HSIR low	ΔR high	ΔR middle	ΔR low
April 1999	217,313	315,103	265,121	241,217	1,956	956	478
May 1999	1,909,234	2,768,389	2,329,266	2,119,250	17,183	8,401	4,200
June 1999	1,740,490	2,523,710	2,123,397	1,931,943	15,664	7,658	3,829
July 1999	984,522	1,427,557	1,201,117	1,092,820	8,861	4,332	2,166
August 1999	293,012	424,867	357,475	325,243	2,637	1,289	645
September 1999	465,298	674,682	567,663	516,480	4,188	2,047	1,024
1999 total	5,609,868	8,134,308	6,844,039	6,226,953	50,489	24,683	12,342
April 2000	216,710	314,230	264,386	240,548	1,950	954	477
May 2000	1,536,839	2,228,417	1,874,944	1,705,892	13,832	6,762	3,381
June 2000	1,274,531	1,848,070	1,554,928	1,414,730	11,471	5,608	2,804
July 2000	527,857	765,393	643,986	585,922	4,751	2,323	1,161
August 2000	456,212	661,508	556,579	506,396	4,106	2,007	1,004
September 2000	451,144	654,159	550,396	500,770	4,060	1,985	993
2000 total	4,463,295	6,471,777	5,445,220	4,954,257	40,170	19,639	9,820
Annual means	5,036,582	7,303,043	6,144,630	5,590,605	45,330	22,161	11,081

Table 77: Estimated potential effects of HSIR on recharge of the Brazos River to Sabine River Segment of the Gulf Coast Aquifer; R = 2% per Table 24; all units below are given in acre-feet.

Date	NSR	HSIR high	HSIR middle	HSIR low	ΔR high	ΔR middle	ΔR low
April 1999	255,323	370,219	311,494	283,409	2,298	1,123	562
May 1999	1,558,784	2,260,237	1,901,716	1,730,250	14,029	6,859	3,429
June 1999	1,283,876	1,861,621	1,566,329	1,425,103	11,555	5,649	2,825
July 1999	935,012	1,355,768	1,140,715	1,037,864	8,415	4,114	2,057
August 1999	237,553	344,453	289,815	263,684	2,138	1,045	526
September 1999	440,183	638,266	537,024	488,604	3,962	1,937	968
1999 total	4,710,733	6,830,563	5,747,094	5,228,914	42,397	20,727	10,367
April 2000	239,714	347,585	292,451	266,082	2,157	1,055	527
May 2000	1,312,800	1,903,561	1,601,617	1,457,208	11,815	5,776	2,888
June 2000	945,435	1,370,880	1,153,430	1,049,433	8,509	4,160	2,080
July 2000	449,255	651,420	548,091	498,673	4,043	1,977	988
August 2000	492,659	714,356	601,044	546,852	4,434	2,168	1,084
September 2000	765,668	1,110,219	934,115	849,892	6,891	3,369	1,684
2000 total	4,205,531	6,098,020	5,130,748	4,668,140	37,849	18,505	9,251
Annual means	4,458,132	6,464,292	5,438,921	4,948,527	40,123	19,616	9,809

Table 78: Estimated potential effects of HSIR on recharge of the Northwest Segment of the Ogallala Aquifer; R = 2.5% per Table 2 4; all units below are given in acre-feet.

Date	NSR	HSIR high	HSIR middle	HSIR low	ΔR high	ΔR middle	ΔR low
April 1999	504,246	731,157	615,180	559,713	5,673	2,773	1,387
May 1999	289,060	419,137	352,653	320,857	3,252	1,590	795
June 1999	742,914	1,077,226	906,355	824,635	8,358	4,086	2,043
July 1999	236,048	342,269	287,978	262,013	2,656	1,298	649
August 1999	158,149	229,316	192,942	175,545	1,779	870	435
September 1999	225,693	327,255	275,346	250,520	2,539	1,241	621
1999 total	2,156,111	3,126,360	2,630,455	2,393,283	24,257	11,858	5,930
April 2000	196,833	285,408	240,137	218,485	2,214	1,083	541
May 2000	233,152	338,070	284,445	258,799	2,623	1,282	642
June 2000	1,266,510	1,836,439	1,545,142	1,405,826	14,248	6,966	3,482
July 2000	524,568	760,624	639,973	582,271	5,901	2,885	1,443
August 2000	220,450	319,653	268,949	244,700	2,480	1,212	606
September 2000	81,062	117,539	98,895	89,978	912	446	223
2000 total	2,522,575	3,657,733	3,077,541	2,800,058	28,378	13,874	6,937
Annual means	2,339,343	3,392,047	2,853,998	2,596,671	26,318	12,866	6,434

Table 79: Estimated potential effects of HSIR on recharge of the Northeast Segment of the Ogallala Aquifer; R = 2.2% per Table 24; all units below are given in acre-feet.

Date	NSR	HSIR high	HSIR middle	HSIR low	ΔR high	ΔR middle	ΔR low
April 1999	661,006	958,459	806,427	733,717	6,544	3,199	1,600
May 1999	533,829	774,052	651,271	592,550	5,285	2,584	1,292
June 1999	901,768	1,307,563	1,100,156	1,000,962	8,927	4,365	2,182
July 1999	338,438	490,735	412,894	375,666	3,351	1,638	819
August 1999	60,889	88,290	74,285	67,587	603	295	147
September 1999	454,872	659,565	554,944	504,908	4,503	2,202	1,101
1999 total	2,950,802	4,278,663	3,599,978	3,275,390	29,213	14,283	7,141
April 2000	427,955	620,535	522,106	475,031	4,237	2,071	1,036
May 2000	509,950	739,428	622,139	566,045	5,049	2,468	1,234
June 2000	1,698,176	2,462,355	2,071,774	1,884,975	16,812	8,219	4,110
July 2000	503,710	730,380	614,526	559,118	4,987	2,438	1,219
August 2000	97,089	140,778	118,448	107,768	961	470	235
September 2000	22,221	32,221	27,110	24,666	220	108	54
2000 total	3,259,102	4,725,697	3,976,104	3,617,603	32,266	15,774	7,888
Annual means	3,104,952	4,502,180	3,788,041	3,446,497	30,740	15,029	7,515

Table 80: Estimated potential effects of HSIR on recharge of the Central Segment of the Ogallala Aquifer; R = 2.4% per Table 24; all units below are given in acre-feet.

Date	NSR	HSIR high	HSIR middle	HSIR low	ΔR high	ΔR middle	ΔR low
April 1999	858,738	1,245,170	1,047,660	953,199	9,274	4,534	2,267
May 1999	788,183	1,142,865	961,583	874,883	8,512	4,162	2,081
June 1999	1,128,946	1,636,972	1,377,314	1,253,130	12,193	5,961	2,980
July 1999	604,711	876,832	737,748	671,230	6,531	3,193	1,596
August 1999	228,543	331,387	278,822	253,682	2,468	1,207	603
September 1999	736,612	1,068,088	898,667	817,640	7,955	3,889	1,945
1999 total	4,345,783	6,301,313	5,301,794	4,823,764	46,933	22,946	11,472
April 2000	175,866	255,005	214,556	195,211	1,899	929	464
May 2000	441,007	639,460	538,028	489,518	4,763	2,329	1,164
June 2000	1,649,564	2,391,867	2,012,468	1,831,016	17,815	8,710	4,355
July 2000	585,158	848,479	713,892	649,525	6,320	3,090	1,545
August 2000	111,942	162,316	136,569	124,255	1,209	591	296
September 2000	22,425	32,517	27,359	24,892	242	118	59
2000 total	2,985,961	4,329,644	3,642,872	3,314,417	32,248	15,767	7,883
Annual means	3,665,847	5,315,479	4,472,333	4,069,091	39,591	19,357	9,678

Table 81: Estimated potential effects of HSIR on recharge of the Southern Segment of the Ogallala Aquifer; R = 2.7% per Table 24; all units below are given in acre-feet.

Date	NSR	HSIR high	HSIR middle	HSIR low	ΔR high	ΔR middle	ΔR low
April 1999	1,055,837	1,530,964	1,288,121	1,171,979	12,828	6,272	3,136
May 1999	1,225,499	1,776,974	1,495,109	1,360,304	14,890	7,279	3,640
June 1999	2,018,139	2,926,302	2,462,130	2,240,135	24,520	11,988	5,994
July 1999	484,415	702,402	590,987	537,701	5,886	2,877	1,439
August 1999	547,486	793,854	667,933	607,709	6,652	6,652	1,626
September 1999	813,231	1,179,185	992,141	902,686	9,881	4,831	2,415
1999 total	6,144,607	8,909,681	7,496,421	6,820,514	99,177	39,899	18,250
April 2000	203,639	295,276	248,439	226,039	2,474	1,210	605
May 2000	321,323	465,919	392,015	356,669	3,904	1,909	954
June 2000	2,163,546	3,137,141	2,639,526	2,401,536	26,287	12,851	6,426
July 2000	623,234	903,689	760,345	691,790	7,572	3,702	1,851
August 2000	294,136	426,498	358,846	326,491	3,574	1,747	874
September 2000	21,712	31,483	26,489	24,100	264	129	64
2000 total	3,627,590	5,260,005	4,425,660	4,026,625	44,075	21,548	10,774
Annual means	4,886,099	7,084,843	5,961,041	5,423,570	71,262	30,724	14,512

Table 82: Estimated potential effects of HSIR on recharge of the Lower Glen Rose Segment of the Trinity Aquifer; R = 20.1% per Table 24; all units below are given in acre-feet.

Date	NSR	HSIR high	HSIR middle	HSIR low	ΔR high	ΔR middle	ΔR low
April 1999	52,502	99,754	76,128	64,052	9,498	4,749	2,322
May 1999	104,470	198,493	151,481	127,453	18,899	9,449	4,620
June 1999	115,194	218,869	167,032	140,537	20,839	10,419	5,094
July 1999	97,259	184,793	141,026	118,656	17,594	8,797	4,301
August 1999	17,088	32,468	24,778	20,848	3,091	1,546	756
September 1999	23,958	45,521	34,740	29,229	4,334	2,167	1,059
1999 total	410,472	779,897	595,185	500,776	74,255	37,127	18,152
April 2000	54,689	103,909	79,299	66,720	9,893	4,947	2,418
May 2000	112,023	212,845	162,434	136,669	20,265	10,133	4,954
June 2000	112,122	213,033	162,578	136,789	20,283	10,142	4,958
July 2000	41,274	78,420	59,847	50,354	7,466	3,733	1,825
August 2000	18,632	35,402	27,017	22,732	3,371	1,685	824
September 2000	82,420	156,597	119,508	100,552	14,910	7,455	3,639
2000 total	421,160	800,205	610,683	513,816	76,188	38,095	18,618
Annual means	415,816	790,051	602,934	507,296	75,222	37,611	18,385

Table 83: Estimated potential effects of HSIR on recharge of the South Central Segment of the Trinity Aquifer; R = 6.5% per Table 24; all units below are given in acre-feet.

Date	NSR	HSIR high	HSIR middle	HSIR low	ΔR high	ΔR middle	ΔR low
April 1999	43,706	83,041	63,373	53,321	2,557	1,278	625
May 1999	167,507	318,263	242,885	204,358	9,799	4,900	2,395
June 1999	69,366	131,796	100,581	84,627	4,058	2,029	992
July 1999	42,201	80,182	61,192	51,486	2,469	1,234	604
August 1999	6,947	13,200	10,074	8,476	406	203	99
September 1999	26,497	50,344	38,421	32,326	1,550	775	379
1999 total	356,224	676,826	516,525	434,594	20,839	10,419	5,094
April 2000	69,270	131,613	100,441	84,509	4,052	2,026	991
May 2000	116,487	221,326	168,907	142,115	6,802	3,407	1,666
June 2000	130,594	248,129	189,361	159,325	7,640	3,820	1,868
July 2000	10,533	20,013	15,273	12,851	616	308	151
August 2000	7,158	13,601	10,380	8,733	419	209	102
September 2000	42,429	80,615	61,522	51,763	2,482	1,241	607
2000 total	376,472	715,296	545,884	459,296	22,011	11,011	5,385
Annual means	3366,348	696,061	531,205	446,945	21,425	10,715	5,240

Table 84: Estimated potential effects of HSIR on recharge of the North Central Segment of the Trinity Aquifer; R = 4% per Table 24; all units below are given in acre-feet.

Date	NSR	HSIR high	HSIR middle	HSIR low	ΔR high	ΔR middle	ΔR low
April 1999	146,282	277,935	212,108	178,464	5,245	2,633	1,287
May 1999	367,379	698,019	532,699	448,202	13,226	6,613	3,233
June 1999	352,700	670,130	511,415	430,294	12,697	6,349	3,104
July 1999	72,804	138,327	105,565	88,820	2,621	1,310	641
August 1999	28,634	54,405	41,520	34,934	1,031	515	252
September 1999	82,404	156,568	119,486	100,533	2,967	1,483	725
<i>1999 total</i>	<i>1,050,203</i>	<i>1,995,385</i>	<i>1,522,794</i>	<i>1,281,247</i>	<i>37,787</i>	<i>18,903</i>	<i>9,242</i>
April 2000	197,676	375,585	286,630	241,165	7,116	3,558	1,740
May 2000	181,022	343,942	262,482	220,847	6,517	3,258	1,593
June 2000	378,445	719,045	548,745	461,703	13,624	6,812	3,330
July 2000	24,553	46,651	35,602	29,955	884	442	216
August 2000	215	408	312	262	8	4	2
September 2000	46,736	88,799	67,768	57,018	1,683	841	411
<i>2000 total</i>	<i>828,647</i>	<i>1,574,430</i>	<i>1,201,539</i>	<i>1,010,950</i>	<i>29,832</i>	<i>14,915</i>	<i>7,292</i>
<i>Annual means</i>	<i>939,425</i>	<i>1,784,908</i>	<i>1,362,167</i>	<i>1,146,099</i>	<i>33,810</i>	<i>16,909</i>	<i>8,267</i>

Table 85: Estimated potential effects of HSIR on recharge of the Northern Segment of the Trinity Aquifer; R = 1.5% per Table 24; all units below are given in acre-feet.

Date	NSR	HSIR high	HSIR middle	HSIR low	ΔR high	ΔR middle	ΔR low
April 1999	99,314	188,697	144,006	121,163	1,341	670	328
May 1999	372,605	707,949	540,277	454,578	5,030	2,515	1,230
June 1999	130,540	248,025	189,282	159,258	1,762	881	431
July 1999	30,129	57,246	43,688	36,758	407	203	99
August 1999	26,318	50,005	38,161	32,108	355	178	87
September 1999	94,838	180,193	137,516	115,703	1,280	640	313
<i>1999 total</i>	<i>753,745</i>	<i>1,432,115</i>	<i>1,092,930</i>	<i>919,568</i>	<i>10,175</i>	<i>5,087</i>	<i>2,490</i>
April 2000	243,152	461,989	352,570	296,645	3,283	1,641	802
May 2000	150,113	285,214	217,664	183,138	2,027	1,013	495
June 2000	220,251	418,477	319,364	268,706	2,973	1,487	727
July 2000	41,705	79,240	60,473	50,880	563	282	138
August 2000	28	53	41	34	0	0	0
September 2000	36,630	69,597	53,114	44,689	495	247	121
<i>2000 total</i>	<i>691,879</i>	<i>1,314,570</i>	<i>1,003,224</i>	<i>844,092</i>	<i>9,341</i>	<i>4,670</i>	<i>2,283</i>
<i>Annual means</i>	<i>722,812</i>	<i>1,373,343</i>	<i>1,048,077</i>	<i>881,830</i>	<i>9,758</i>	<i>4,879</i>	<i>2,387</i>

Figure 18 plots the annual means for Tables 61-85, with the hypothetical changes in recharge from hypothetical HSIR ordered from highest to lowest ΔR . Note that a log scale is being used on the ordinate such that the values do not increase linearly along the axis. While there is considerable variation, the decrease in recharge correlates to an expected general decrease in recharge zone size and recharge rates. The variation is primarily the result of some significantly different recharge rates. Of the 25 aquifer segments examined, 18 have recharge rates of 5% or less, and 21 have rates of 8% or less. The remaining four aquifer segments, the three segments of the Edwards (Balcones Fault Zone) Aquifer and the Lower Glen Rose Segment of the Trinity Aquifer, were calculated with recharge rates of 15.7 to 21.7% of precipitation.

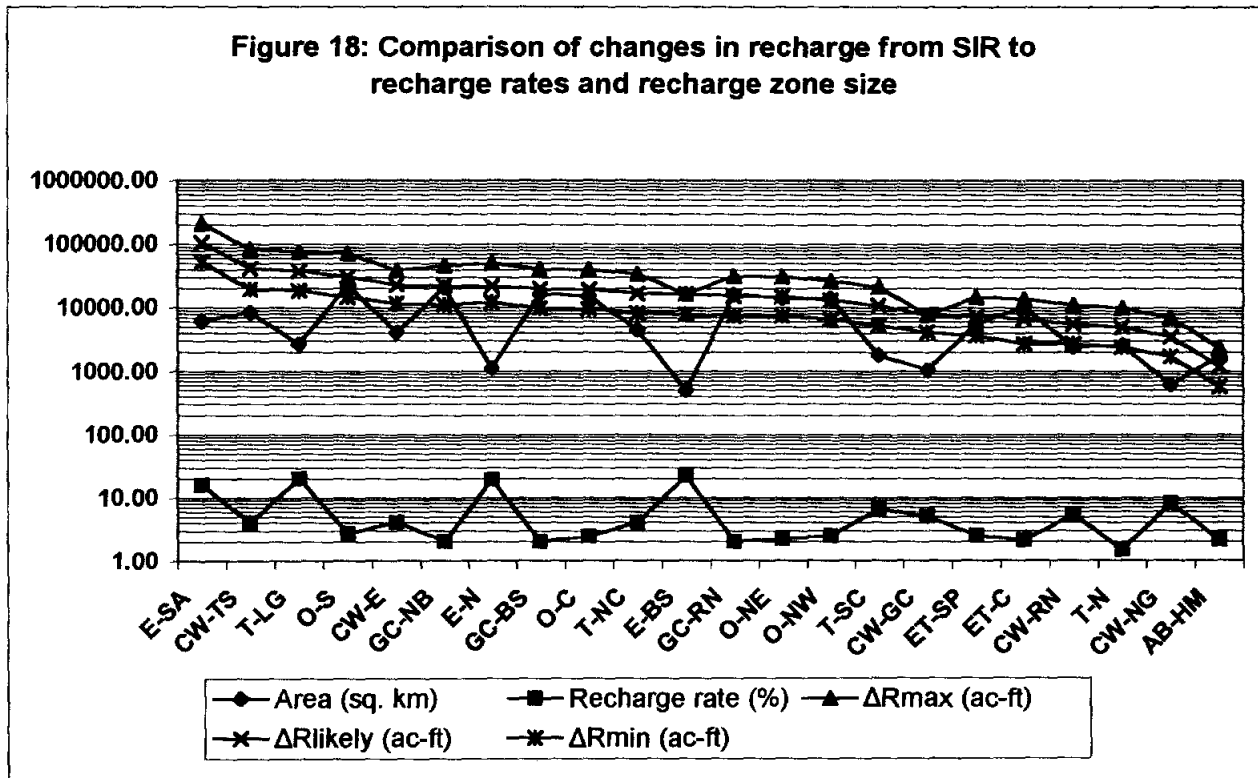

The four highest recharge percentages occur for karst aquifers where permeability and consequently, recharge potential is highest. While it is possible that the percentages may be too high, they probably are not too far off. The value for the Lower Glen Rose Segment of the Trinity Aquifer was calculated by a water balance study, yet is similar to the values of the Edwards (Balcones Fault Zone) Aquifer segments which were calculated here based on known recharge volume, recharge zone size, and mean rainfall. In contrast, the three segments of the karstic Edwards-Trinity Aquifer were calculated at rates of 2.1 to 2.5%, based on published recharge rates. These rates, while the best available, are almost certainly too low and are based on preliminary and incomplete data. A study of the San Felipe Springs, which drain recharge from about 1,910 km² of the southwest section of the aquifer's Central Segment, indicates that at least 9% of precipitation in that area becomes recharge (Veni, 2001). The general studies on recharge and ET for most Texas porous media aquifers may be sufficient given their comparative

low permeabilities and relatively low variations in permeability, but more detailed recharge and water balance investigations are needed for the karst aquifers.

The aquifers where hypothetical HSIR might produce the greatest proportional increases in recharge are illustrated in Figure 19. The likely changes in recharge due to HSIR are divided by the size of the recharge zones as modeled in this study to produce comparable values and are shown in the figure in descending order; recharge area, recharge rates, and the volumetric change in recharge are also shown. With minor exceptions, the aquifers of higher permeability with recharge rates greater than 4% allow the most recharge per unit area. These include the Edwards (Balcones Fault Zone) Aquifer, the Carrizo-Wilcox Aquifer, and the Trinity Aquifer. Exceptions include the Carrizo-Wilcox's Rio Grande to Nueces River Segment and the Northern Segment of the Trinity Aquifer. Without a doubt, the Edwards-Trinity Aquifer should rank highly but is shown with low unit recharge potential due to the limits in the available data. The Ogallala, Gulf Coast, and Alluvium and Bolson aquifers contain sufficient silts and clays that allow greater runoff and ET, and thus slow the rate of recharge.

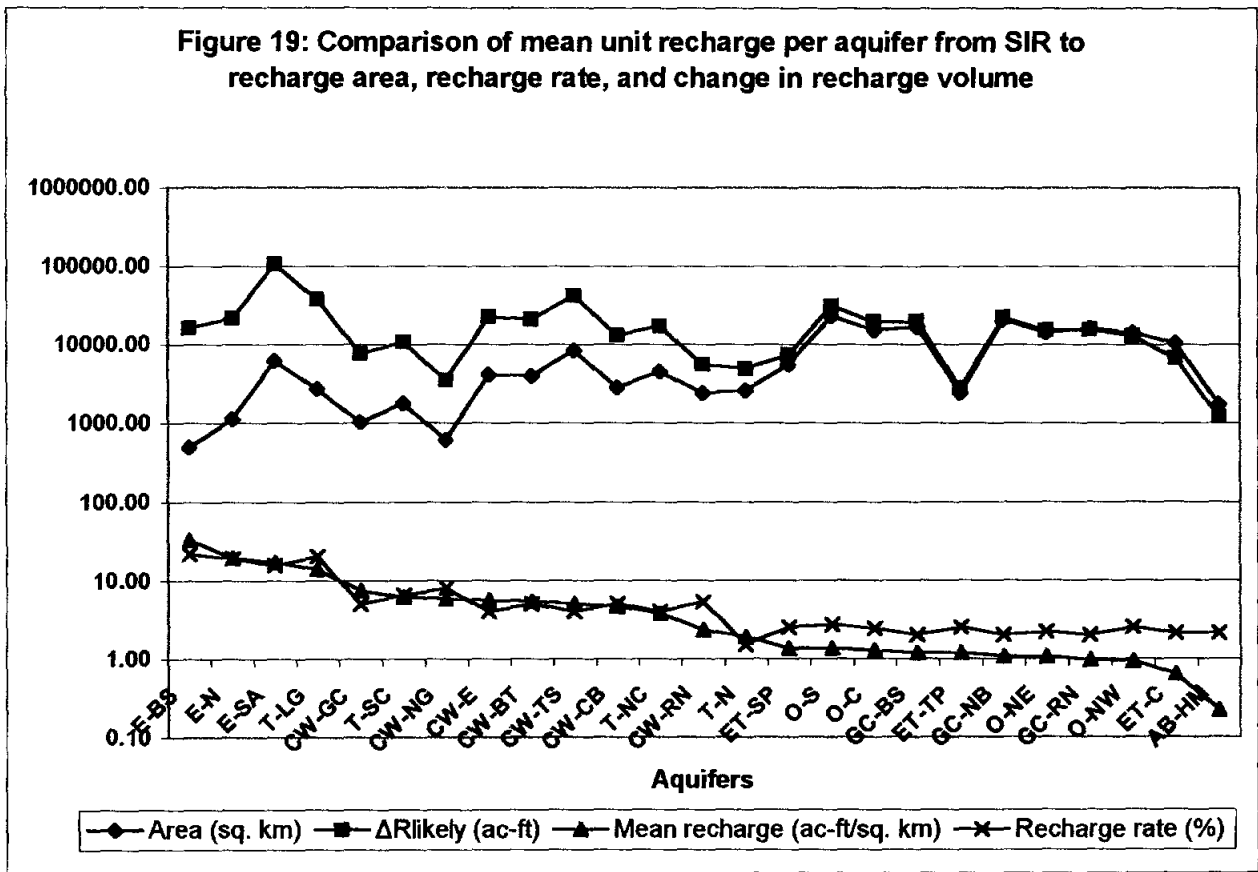

The identification of aquifers that are better suited to receiving HSIR requires consideration of the aquifers' hydrogeologic regime. Parts of the Trinity Aquifer occur atop plateaus and ridges in terrains that are highly dissected by streams. In those areas, the water tables are shallow and cannot build significantly higher due to discharge into the nearby valleys.

The Edwards-Trinity and Ogallala aquifers have the same problem in principle, but they cover much larger areas, have a much smaller ratio of plateau area to dissected margin, and consequently drain far more slowly. Even though less HSIR may proportionally recharge the Ogallala than the Trinity, it is likely that recharge into the Ogallala will have a longer residence time and is thus more likely to be tapped by wells in the region.

Artesian aquifers like the Edwards, Carrizo-Wilcox, Gulf Coast, and parts of the Trinity generally have a greater capacity to store for groundwater than shallow plateau aquifers of comparable lithologies. Springs are usually fewer, groundwater velocity tends to be slower, and so conditions are usually more favorable for long-term storage and retrieval of recharge. However, the usefulness of HSIR recharge into artesian aquifers is compromised by other factors. The position of the water table relative to the land surface will affect the ability of an aquifer to recharge. Portions of the Carrizo-Wilcox and Gulf Coast aquifers, especially near the coast and in east Texas, have their water tables within a few meters or less from the surface so that while they can accept recharge at rates of up to 5% of precipitation, they have little available storage, quickly fill, and can accept no more water. Also, the high karstic permeability of the Edwards Aquifer that allows its high recharge potential allows it to discharge that water at a more rapid rate. Nonetheless, its artesian setting allows for a much greater thickness of the Edwards Limestone to become saturated than would a comparable section of the limestone on the Edwards Plateau, and to store that water for longer periods, making it more available for capture and use.

The seasonality in the impacts of HSIR found in the examination of surface water is also apparent with groundwater. HSIR during August would generally produce the least recharge both proportionally and volumetrically, followed by HSIR in July and September. There is less seasonal effect over the Gulf Coast Aquifer.

Considering the factors discussed above on the aquifers' capacities to receive and retain recharge, plus details of the hydrogeology summarized in Appendix F, the aquifers that are probably best suited for HSIR are the Edwards, Carrizo-Wilcox (excluding the Eastern and Trinity to Sulfur River segments), Trinity (excluding the Northern Segment), Edwards-Trinity, and Ogallala (Central and Southern Segments).

13.4 Edwards Aquifer Focused Calculations

13.4.1 HSIR during historic Edwards Aquifer conditions

Three mean periods are defined here based on historic Edwards Aquifer data: below-normal, normal, and above-normal rainfall volumes that generally correlate to water levels in the aquifer. In defining these three periods, it is important to recognize that the available data contain limitations in their use and application to this study. Esquilin (2000) provided mean annual precipitation data for the Edwards Aquifer region for the years 1934-1999. He did not calculate regional means for each year. The sizes of the recharge zone segments he listed vary considerably and weighted precipitation rates would need to be calculated to determine a regional mean. While this is possible, the quality of the data would vary an unknown amount with time due to changes in the rain gauging system.

The three study periods could also be defined based on total annual recharge data, also provided by Esquilin (2000). Annual recharge for the aquifer reflects annual precipitation throughout the recharge zone and serves as a good measure of regional precipitation. However, aquifer recharge has also changed over the years with the construction of several recharge dams to increase the rate of recharge, and numerous flood control dams that often coincidentally serve the same purpose. As a result, since about 1970, the percentage of recharge per unit volume of precipitation has increased as more dams have been constructed, so the earlier part of the period of record is not easily correlated to the modern portion of the record.

For the purposes of this study, the precipitation record for San Antonio (provided by Esquilin, 2000) is used to define the below-normal, normal, and above-normal rainfall periods. Comparing the plots of San Antonio's precipitation and annual aquifer recharge shows a general similarity and only minor disparities between the records and indicate that overall the San Antonio record is proportionally representative of rainfall throughout the aquifer recharge zone. Precipitation in San Antonio during the 1934-1999 period of aquifer record has a mean of 76.2 cm/year and ranges from a low of 34.8 cm in 1954 to a high of 132.8 cm in 1973. Table 86 lists three years selected for analysis for each type of rainfall period and provides their gauged rainfall.

Table 86: Precipitation measured in San Antonio used as representative of rainfall means and extremes.

Below-normal rainfall years		Normal rainfall years		Above-normal rainfall years	
Year	Precipitation (cm)	Year	Precipitation (cm)	Year	Precipitation (cm)
1988	48.3	1960	75.6	1986	108.5
1996	45.2	1967	74.3	1992	118.1
1999	42.2	1977	75.3	1998	106.9

Table 69 lists the calculated hypothetical minimum, likely, and maximum increases in recharge to the San Antonio Segment of the Edwards Aquifer. The data for 1999, which is one of the below-normal rainfall years, are applied in Table 87 to the three below-normal years. The data for 2000 are applied in Table 87 to the normal and above-normal years. The data are compared to the J-17 well, located in San Antonio. The well is used as the aquifer index well because of its long period of record, good correlation to general aquifer levels, and good correlation to discharge from the Comal Springs. Measurements at the well indicate that a 0.3-m change in water level equates to an approximate change of 40,000 acre-feet (49.3 million m³) of water in storage (Fisher, 1990). The water level elevations in this well are used to guide mandated pumping limits and water use restrictions in the area, so applying HSIR-based recharge to the elevations provide a direct reference to HSIR's impact on relieving water quantity problems. However, the results of Thorkildsen and McElhaney (1992) indicate that not all of the groundwater in the western portion of the recharge zone flows to San Antonio, the J-17 well, and the Comal and San Marcos Springs, with 33-66% discharging from other springs, wells en route, and possible leakage into other aquifers. As a result, only 70% of the recharge in Table 69 is used in Table 87, which calculates the hypothetical impacts of HSIR as measured at J-17.

Two things are immediately evident in Table 87. First, mean annual levels in J-17 do not

always represent mean precipitation. For example, the water levels for 1996 represent the low precipitation that occurred in the region, but low precipitation in 1999 is masked by elevated water levels from high precipitation in 1998. Second, the mean annual effect of HSIR on aquifer levels seems minor. Water levels in J-17 during the below-normal years rise about 0.2% and in the normal and above-normal years rise about 0.37%. However, the contribution is more significant when considered in terms of actual recharge; 50,464 acre-feet (62.2 million m³) of likely recharge during below-normal rainfall periods and 97,840 acre-feet (120.7 million m³) of likely recharge occurred during normal and above-normal rainfall periods. Current mandates on water use from the aquifer limit withdrawals to 450,000 acre-feet/year (555.1 million m³/year). This hypothetical likely recharge from HSIR constitutes an 11.2 to 21.7% increase in groundwater in the aquifer relative to the 450,000 acre-foot cap.

Table 87: Estimated effects of mean annual recharge from HSIR on the mean elevation of the potentiometric surface in the San Antonio Segment of the Edwards (Balcones Fault Zone) Aquifer as represented at the J-17 well; J-17 values are given in feet above mean sea level and R values are given in feet.

Year	J-17	R high	R middle	R low	J-17high	J-17mid	J-17low
<i>Below-normal rainfall years</i>							
1988	664.69 ^b	2.52	1.26	0.62	667.21	665.95	665.31
1996	644.74 ^a	2.52	1.26	0.62	647.26	646.00	645.36
1999	670.40 ^a	2.52	1.26	0.62	672.92	671.66	671.02
<i>Normal rainfall years</i>							
1960	671.50 ^c	4.83	2.45	1.23	676.33	673.95	672.73
1967	646.20 ^c	4.83	2.45	1.23	651.03	648.65	647.43
1977	684.20 ^c	4.83	2.45	1.23	689.03	686.65	685.43
<i>Above-normal rainfall years</i>							
1986	671.50 ^c	4.83	2.45	1.23	676.33	673.95	672.73
1992	691.98 ^b	4.83	2.45	1.23	696.81	694.43	693.21
1998	667.68 ^a	4.83	2.45	1.23	672.51	670.13	668.91

^a = Data from Edwards Aquifer Authority website: <http://www.e-aquifer.com/field/wtrlevel.htm>

^b = Data from Walthour, Waugh, and O'Conner (1995).

^c = Data from Brown, Petri, and Nalley (1992).

The data in Table 87 are too coarse to effectively assess the monthly or daily impacts on the aquifer, when water levels may fluctuate near the thresholds that trigger various community water conservation requirements. More detailed analyses are also beyond the scope of this study. Nonetheless, the data show that less HSIR will be produced during years of below-normal rainfall and thus will have less of an effect during the years when it is needed most. However, HSIR during normal rainfall years may prove more effective by boosting aquifer levels so they remain high for longer periods during subsequent below-normal years. The two modeled HSIR years of 1999 and 2000 do not represent data that adequately represent above-normal rainfall years. Higher values for such years are more likely than those given in Table 87, but they may be tempered by higher discharge rates. During record high aquifer levels in 1992, many new, high elevation springs temporarily developed and caused water to discharge even faster from the aquifer than through just the previously known springs. Yet the pressure of high aquifer levels

also forced more water into the high volume but low permeability storage component of the aquifer that is drained by low potentiometric levels and not sufficiently restored by mean conditions. Maximizing storage in this portion of the aquifer is important to minimizing the rate at which potentiometric levels drop in response to pumping and springflow. Additional research is needed to weigh the merits of HSIR during above-normal rainfall conditions.

13.4.2 HSIR in a typical Edwards Aquifer watershed

Hondo Creek is located in Medina County and is typical of mid-size streams that recharge the Edwards Aquifer. In 1952 the USGS established a gauging station, "Hondo Creek near Tarpley," located where the creek flows onto the recharge zone from the outcrop of the upper member of the Glen Rose Formation on the contributing zone. The USGS established a complimentary station in 1960, "Hondo Creek at King Waterhole near Hondo," approximately 2.5 km below the downstream end of the recharge zone; the edge of the recharge zone is covered by gravel so its precise position has not been mapped along the creek. The purpose of the two stations is to measure the loss of water along the creek as it flows across the recharge zone.

Land et al. (1983) determined that during a monitored storm event in May 1981, Hondo Creek recharged the aquifer at a rate of 315.5 acre-feet/day ($4.5 \text{ m}^3/\text{s}$) with 88% occurring in the recharge zone and 12% in the contributing zone. Through linear regression analysis, they calculated that a minimum discharge of 127 acre-feet/day ($1.8 \text{ m}^3/\text{s}$), varying from 99 to 446 acre-feet/day (1.4 to $6.4 \text{ m}^3/\text{s}$), was needed at the station near Tarpley to allow the creek to flow through the recharge zone without being completely captured by the aquifer. Since some of the minimum flow-through discharge rates are much lower than the measured loss of 315.5 acre-feet/day, significant contributions to recharge and streamflow must occur by precipitation within the recharge zone.

Puente (1975, 1978) calculated approximate precipitation in the Edwards Aquifer recharge and contributing zones and compared them to stream loss data to estimate recharge into the aquifer. Equation 3 is used in this investigation to calculate recharge in the Hondo Creek basin in a similar way and determine the likely effects of HSIR on aquifer recharge and stream discharge. The Hondo Creek basin is defined as the area upstream of the King Waterhole gauging station. Most of the parameters in equation 3 are calculated as described earlier in this report. However, since Hondo Creek is much smaller than the surface drainage basins previously examined, N is based on the number of daily precipitation records of at least 10 million m^3 , an order of magnitude less than with the larger basins. Despite this threshold only equating to a mean 3.13 cm of precipitation throughout the Hondo Creek basin, little rainfall occurred in the basin during 1999 and 2000 and this limit was not met. A smaller rainfall volume was not used because less than 3 cm of rainfall in this area usually does not produce sufficient runoff to measure as streamflow.

Two parameters introduced by equation 3 are L_{NSR} and L_{HSIR} . L_{NSR} is derived directly from the streamflow measured at the Hondo Creek at King Waterhole gauging station. L_{HSIR} is the hypothetical streamflow at that gauging station that would occur following HSIR storm events. It is determined in Table 88 by two methods. The first divides monthly HSIR for the Hondo Creek basin by the area of the basin to get mean monthly precipitation (P). This value is

then compared to mean monthly rainfall for the Hondo Municipal Airport weather station (data from the National Oceanic and Atmospheric Administration website: <https://ols.nndc.noaa.gov>), located 4 km southwest of the King Waterhole gauging station, to identify historic monthly precipitation periods of similar intensity. Assuming the general hydrologic conditions are similar to the modeled period, such as not following major floods, the stream discharge measured for the King Waterhole station (or the mean discharge if multiple discharges are documented) is recorded in Table 88 as L_{HSIR} . This method is limited by the maximum recorded precipitation for the basin, which several HSIR values exceed. For those, the second method is used to determine L_{HSIR} . In that method a linear regression was calculated for the L_{HSIR} values derived from the first method (including values not listed in Table 88), and L_{HSIR} values were extrapolated for higher than recorded precipitation. L_{HSIR} values calculated by the first method are identified in Table 88 by cited sources for comparative historical precipitation. L_{HSIR} values calculated by the second method have no citations.

The calculations for L_{HSIR} required some adjustment. The monthly mean precipitation data do not distinguish between precipitation spread throughout the month that causes no change in streamflow from that which falls in a single, brief, intense storm that produces major changes in stream discharge. Consequently, the historical data exhibit considerable variation in discharge from similar volumes of monthly precipitation, including seemingly contradictory results with months of high precipitation producing less runoff than months with less precipitation. The only historic streamflow found that correlated to 5.64 and 5.68 cm of precipitation in Table 88 was over an order of magnitude greater than streamflow that correlated to 5.05 cm of precipitation. This larger figure was disregarded as anomalous in order to develop a regression that provided more realistic results. Another figure that was adjusted in Table 88 was the minimum L_{HSIR} for August 1999. Historic data for that period yielded no streamflow for the higher precipitations, but moderate streamflow for the minimum precipitation. Since the intent in using the historic data is to represent actual mean conditions, the minimum L_{HSIR} was changed to reflect no streamflow as more typical.

Table 89 lists the data used in calculating the changes in recharge due to HSIR and the results. The baseline data generated by WWC provided equal numbers for HSIRmax and HSIRlikely, thus there is no difference between those categories. Except for August 2000, at least 2,337 acre-feet (2.88 million m^3) up to 11,071 acre-feet (13.66 million m^3) of water would hypothetically recharge the Edwards Aquifer each month in the Hondo Creek drainage basin under the calculated maximum to likely scenario. Under the minimum scenario, not counting August 2000, 1,168 acre-feet (1.44 million m^3) to 3,950 acre-feet (4.87 million m^3) of water would hypothetically recharge the Edwards every month.

In comparing the results of Table 89 to Table 69, which gives the estimated hypothetical recharge for the entire San Antonio Segment of the Edwards Aquifer, there is a discrepancy in the results. The Hondo Creek drainage basin comprises about 4% of the San Antonio Segment's recharge zone, yet the mean minimum and likely recharge for Hondo Creek respectively total 29.2% and 35.9% of the mean minimum and likely recharge for the entire recharge zone. Assuming that the recharge rate measured by Land et al., (1983) for Hondo Creek is sustainable throughout a 30-day month, 9,465 acre-feet (11.7 million m^3) of recharge would enter the aquifer. This figure is larger than all but two of the calculated hypothetical recharge rates in

Table 88: Mean monthly precipitation and hypothetical discharge of Hondo Creek from HSIR at the King Waterhole gauging station; HSIR and L units are given in acre-feet; P units are given in centimeters.

Date	HSIR high	HSIR middle	HSIR low	P high	P middle	P low	Lhigh _{HSIR}	Lmid _{HSIR}	Llow _{HSIR}
April 1999	23,089	23,089	17,620	8.91	8.91	6.80	3,229	3,229	2,465
May 1999	23,711	23,711	18,096	9.15	9.15	6.99	3,316	3,316	2,533
June 1999	30,373	30,373	23,180	11.73	11.73	8.95	4,251	4,251	3,244
July 1999	29,420	29,420	22,452	11.36	11.36	8.67	4,117	4,117	3,142
August 1999	4,934	4,934	3,765	1.90	1.90	1.45	0 ⁷	0 ⁷	0
September 1999	8,108	8,108	6,188	3.13	3.13	2.39	1,414 ^{3,6}	1,414 ^{3,6}	0 ³
April 2000	17,131	17,131	13,074	6.61	6.61	5.05	2,396	2,396	2,488 ⁸
May 2000	26,235	26,235	20,021	10.13	10.13	7.73	3,672	3,672	2,802
June 2000	22,648	22,648	17,284	8.74	8.74	6.67	3,168	3,168	2,417
July 2000	19,292	19,292	14,723	7.45	7.45	5.68	2,700	2,700	2,059
August 2000	3,311	3,311	2,527	1.28	1.28	0.98	1,038 ^{1,2,5,6,8}	1,038 ^{1,2,5,6,8}	36 ^{1,3,4}
September 2000	14,615	14,615	11,154	5.64	5.64	4.31	2,044	2,044	201 ⁴

¹: Buckner, Carrillo, and Davidson (1985)

²: Buckner, Carrillo, and Davidson (1986)

³: Buckner, Carrillo, and Davidson (1987)

⁴: Buckner, Carrillo, and Davidson (1988)

⁵: Buckner and Shelby (1990)

⁶: Buckner and Shelby (1991)

⁷: Gandara et al. (1994)

⁸: USGS website: <http://water.usgs.gov/tx/nwis/sw>

Table 89: Estimated effects of HSIR on recharge to the Edwards Aquifer in the Hondo Creek basin; HSIR, L, and R units are given in acre-feet.*

Date	N	NSR	HSIRhigh	HSIRmid	HSIRlow	L_{NSR}^1	ΔR_{high}	ΔR_{mid}	ΔR_{low}
April 1999	0.005	12,152	23,089	23,089	17,620	0	7,708	7,708	3,002
May 1999	0.005	12,480	23,711	23,711	18,096	0	7,915	7,915	2,300
June 1999	0.005	15,986	30,373	30,373	23,180	0	11,071	11,071	3,950
July 1999	0.005	15,484	29,420	29,420	22,452	0	9,819	9,819	3,826
August 1999	0.005	2,597	4,934	4,934	3,765	0	2,337	2,337	1,168
September 1999	0.005	4,267	8,108	8,108	6,188	0	2,427	2,427	1,921
<i>1999 total</i>	<i>0.001</i>	<i>62,966</i>	<i>119,636</i>	<i>119,636</i>	<i>91,301</i>	<i>0</i>	<i>41,277</i>	<i>41,277</i>	<i>16,167</i>
April 2000	0.005	9,017	17,131	17,131	13,074	0	5,718	5,718	1,569
May 2000	0.005	13,808	26,235	26,235	20,021	0	8,755	8,755	3,411
June 2000	0.005	11,920	22,648	22,648	17,284	0	7,560	7,560	2,947
July 2000	0.005	10,153	19,292	19,292	14,723	0	6,439	6,439	2,511
August 2000	0.005	1,743	3,311	3,311	2,527	0	530	530	748
September 2000	0.005	7,692	14,615	14,615	11,154	0	5,885	5,885	3,426
<i>2000 total</i>	<i>0.001</i>	<i>54,333</i>	<i>103,233</i>	<i>103,233</i>	<i>78,783</i>	<i>0</i>	<i>34,887</i>	<i>34,887</i>	<i>14,612</i>
<i>Annual means</i>	<i>0.001</i>	<i>58,650</i>	<i>111,435</i>	<i>111,435</i>	<i>85,042</i>	<i>0</i>	<i>38,082</i>	<i>38,082</i>	<i>15,390</i>

* Factors in calculating R not given in this table are A, the 319.5 km² drainage area upstream of the Hondo Creek at King Waterhole gauging station, PET, as given for San Antonio in Table 22, and L_{HSIR} values from Table 88.

¹: data from Gandara et al. (2000) and Gandara, Gibbons, and Barbie (2001) for the Hondo Creek gauging station at King Waterhole near Hondo.

Table 89, suggesting that those rates are theoretically possible given sufficient rainfall. However, is it not clear whether these data or those for the overall aquifer in Table 69 are more accurate. It is possible that part of the discrepancy may be due to unmeasured water loss above and below the recharge zone, but this is unlikely or only a minor factor given the small areas involved and their much lower recharge rates. The discussion earlier in this report on the derivation of values in Table 49 suggest that the recharge rate used for the aquifer may be high, yet compared to the Hondo Creek data, it seems low. This affirms the admonition at this beginning of this report that this study is conceptual and not tasked with developing precise numbers. An in-depth study that considers more factors in detail would resolve such differences. As for the scope of this report, Table 89 supports the general evaluation of the Edwards Aquifer that HSIR could significantly increase mean annual recharge, with a possible minimum increase of 2.3% from the Hondo Creek basin.

13.4.3 HSIR on Edwards Aquifer water use versus water recharge areas

The Bexar Metropolitan Water District and San Antonio Water System provide most of the water consumed from the Edwards Aquifer by the city of San Antonio. Both water purveyors provided records of their total pumping for San Antonio for the 1999 and 2000 periods of record for this study. A review of those records shows a consistent decrease in pumping following storm events due to decreases in water demand. Figure 20 illustrates that decrease. The data were determined by summing the drop in pumping following precipitation from pumping rates prior to precipitation. With greater rainfall, pumping rates remained low for longer periods of time, usually gradually ascending over 2-5 days to pre-rainfall levels. The day of the rainfall and the following day were usually summed, although with greater rainfall and obvious significant decline, as much as twice the length of the rainfall period was summed. The rainfall period refers to days of consecutive rainfall. Days with less than 1 cm of precipitation were not considered. Most summed periods in this analysis underestimate the decline in pumping by not counting the entire period of reduced pumping. Attempting to identify which specific days should or should not be summed would require a rigorous statistical analysis of the data plus other factors that affect water use.

Figure 20: Effect of precipitation on pumping of the Edwards Aquifer by San Antonio
 (from data provided by Bexar Metropolitan Water District and San Antonio Water System)

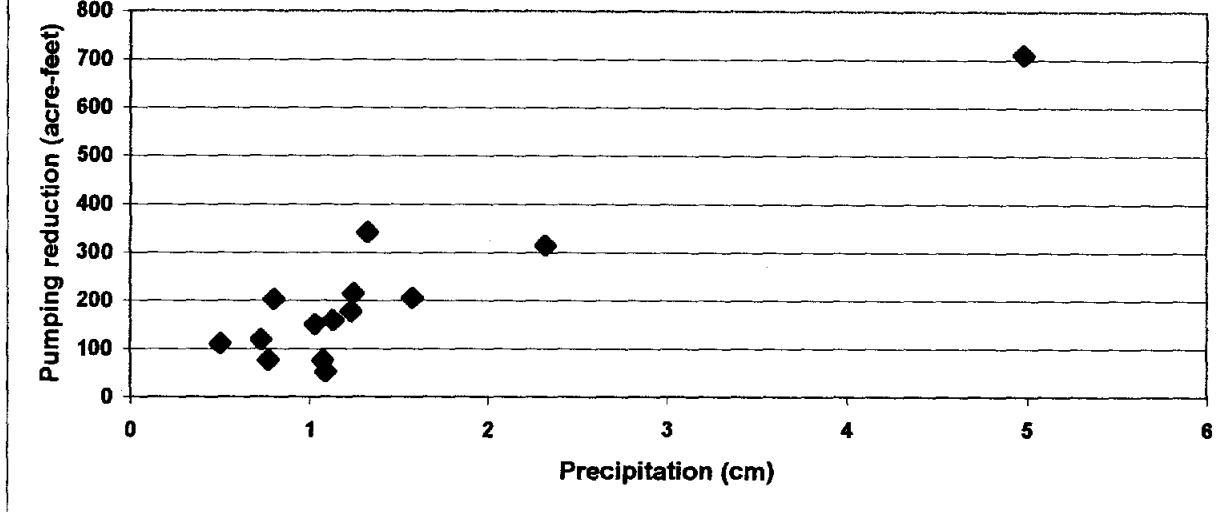

Table 90: Estimated effects of HSIR on urban water use of the Edwards Aquifer in San Antonio; units are given in acre-feet.

Date	N	NSR	HSIR high	HSIR middle	HSIR low	ΔU high*	ΔU middle*	ΔU low*
April 1999	0.012	21,293	40,457	40,457	30,875	404	404	202
May 1999	0.016	36,216	68,810	68,810	52,513	686	686	343
June 1999	0.042	77,381	147,023	147,023	112,202	1,466	1,466	732
July 1999	0.016	38,553	73,251	73,251	55,902	731	731	365
August 1999	0.005	17,861	33,935	33,935	25,898	339	339	169
September 1999	0.008	6,370	12,104	12,104	9,237	121	121	61
<i>1999 total</i>	<i>0.063</i>	<i>197,674</i>	<i>375,581</i>	<i>375,581</i>	<i>286,627</i>	<i>3,747</i>	<i>3,747</i>	<i>1,872</i>
April 2000	0.034	20,018	38,034	38,034	29,026	379	379	189
May 2000	0.024	43,604	82,847	82,847	63,225	826	826	412
June 2000	0.025	55,733	105,893	105,893	80,813	1,055	1,055	527
July 2000	0.008	10,797	20,515	20,515	15,656	205	205	102
August 2000	0.005	9,169	17,422	17,422	13,296	173	173	87
September 2000	0.017	37,051	70,397	70,397	53,724	702	702	350
<i>2000 total</i>	<i>0.014</i>	<i>176,373</i>	<i>335,108</i>	<i>335,108</i>	<i>255,740</i>	<i>3,340</i>	<i>3,340</i>	<i>1,667</i>
<i>Annual means</i>	<i>0.039</i>	<i>187,024</i>	<i>355,345</i>	<i>355,345</i>	<i>271,184</i>	<i>3,544</i>	<i>3,544</i>	<i>1,770</i>

- Based on an area of 845 km², the PET for San Antonio in Table 2, and a regression coefficient of 144.1.

The data in Figure 20 were calculated and found to fit a linear regression coefficient of 144.1 acre-feet (177,750 m³) in pumping reduction for every centimeter of rainfall on the city, "b" in equation 4. Table 90 presents the NSR and HSIR data for the highly urbanized portion of San Antonio, generally south of the northern portion of Loop 1604 to the southern portion of Loop 410, and within the east and west limits of Loop 410 south of U.S. Highway 90 and within the east and west limits of Loop 1604 north of U.S. Highway 90. The data are calculated through the use of equation 4, with N based on the number of daily precipitation records of at least 10 million m³ as with the calculations for Hondo Creek.

To compare the results of Table 90 with HSIR-based recharge into the San Antonio Segment of the Edwards Aquifer and the Hondo Creek drainage basin given in Tables 69 and 89, the recharge volumes are divided by the size of their study areas to yield units of recharge per square kilometer as presented in Table 91. In the case with the San Antonio values, ΔR refers to the volume of water hypothetically not pumped from the aquifer; those values serve the same function in the aquifer's water budget as additional recharge.

Table 91: Comparison of estimated Edwards Aquifer HSIR-based recharge; units are given in acre-feet/km².

Date	ΔR_{high}	ΔR_{middle}	ΔR_{low}
San Antonio Segment recharge zone	54.11	27.27	13.55
Hondo Creek drainage basin	120.70	120.70	48.78
San Antonio urban area	4.19	4.19	2.09

As previously discussed, the Hondo Creek recharge rate is probably high. The recharge rate for the San Antonio Segment could also be high, but if so, probably by only a small margin. In either case, recharge in the San Antonio Segment of the aquifer is about 6-13 times greater than the pumping reductions due to HSIR in San Antonio. While the reductions were conservatively calculated and may be perhaps up to twice as great, they would still provide much less water for the aquifer than HSIR on the aquifer's recharge zone.

13.5 Conclusions

This investigation is a broad, conceptual examination of the hypothetical impacts of HSIR. The values generated for this study are meant to be illustrative of likely general impacts on surface and groundwater resources, consistent with hydrogeologic principles and the hydrogeologic settings of the study areas. The values should not be considered definitive or precise and have not been subjected to an intense statistical analysis since such results would suggest a greater certainty in the values than in fact exists. The data produced by this study are meant to guide future research to areas where HSIR would likely be most productive. The following conclusions are based on this premise and the results of this investigation.

13.5 1 Surface water studies

1) General studies of effective precipitation should limit the size of the watersheds investigated to no more than 10,000 km², or use radar or other means to account for ET losses in

only the rainfall-affected areas.

2) HSIR will have relatively little overall impact on the Lower and Middle basins of the Brazos River, the Middle Basin of the Colorado River, the Lower Basin of the Nueces River, and the Lower and Upper basins of the Trinity River.

3) HSIR is likely to have the most impact, hypothetically ranging from 9 to 17% above mean annual (6-month) historic precipitation, in the Upper Basin of the Brazos River, the Lower and Upper basins of the Colorado and Guadalupe rivers, and the Upper Basin of the Nueces River.

4) HSIR during August hypothetically produces little significant effective rainfall. Low volumes are hypothetically expected during July and September, but hypothetically greater increases may occur if appropriate meteorological conditions are present.

5) The greatest proportional and volumetric change in stream discharge from HSIR may hypothetically occur in the Upper and Lower Basins of the Nueces and Guadalupe rivers, the Lower Basin of the Trinity River, the Middle Basin of the Colorado River, and the Middle Basin of the Brazos River.

6) The smallest proportional and volumetric change in stream discharge from HSIR may hypothetically occur in the Upper Basin of the Colorado River and Upper Basin of the Brazos River.

7) HSIR during August hypothetically produces little or no significant increase in stream discharge, although hypothetically, notable gains may occur in the Lower Basin of the Colorado River, the Upper and Lower basins of the Guadalupe River, and the Lower Basin of the Trinity. Low volumes are hypothetically likely during July and September, but hypothetically significant increases may occur if appropriate meteorological conditions are present.

8) HSIR in the Lower Basin of the Trinity River and possibly in the Lower Basin of the Brazos River should not be applied without further research. The water needs of these areas are currently satisfied by the available water resources, and occasional catastrophic flooding of streams in the northeast part of the coastal bend demand only limited and carefully modeled HSIR, possibly for only July through September when HSIR will have its lowest yield and water demand is highest.

13.5.2 Groundwater studies

1) HSIR will probably be most effective in providing recharge that can be stored and retrieved for use in the following aquifers, listed in descending order of effectiveness: Edwards, Carrizo-Wilcox (excluding the Eastern and Trinity to Sulfur River segments), Trinity (excluding the Northern Segment), Edwards-Trinity, and Ogallala (Central and Southern Segments). Potential recharge from HSIR in these aquifers could occur at mean annual rates of about 4-30 acre-feet/km² of recharge zone.

2) HSIR will probably be least effective in providing recharge that can be stored and retrieved for use in the Gulf Coast Aquifer and the Hueco-Mesilla Bolson Segment of the Alluvium and Bolson aquifers. Potential recharge from HSIR in these aquifers could occur at mean annual rates of about 0.2 to 1.2 acre-feet/km² of recharge zone.

3) HSIR during August hypothetically produces little significant increase in recharge.

13.5.3 Edwards Aquifer focused studies

1) The modeled HSIR data for 1999 and 2000 are adequate for this study's preliminary assessment of the effect of HSIR on aquifer recharge during below-normal and normal rainfall years because they respectively represent below-normal and normal rainfall periods. The modeled data are probably not adequate to effectively assess recharge from HSIR during above-normal rainfall years.

2) During below-normal rainfall years, hypothetically recharge of the aquifer could be increased 50,464 acre-feet/year (62.2 million m³/year) by HSIR.

3) During normal rainfall years, hypothetically recharge of the aquifer could be increased 97,840 acre-feet (120.7 million m³) by HSIR.

4) During above-normal rainfall years, hypothetically recharge of the aquifer could be increased at least 97,840 acre-feet (120.7 million m³) by HSIR. Much recharge during high potentiometric levels typical of such periods would be very short-lived before discharging, but other recharge would enter high volume, low permeability storage. The volumetric gain in storage compared to water loss though increased discharge is not known.

5) Recharge in the Hondo Creek drainage basin could hypothetically be increased 1,168 acre-feet (1.44 million m³) to 11,071 acre-feet (13.66 million m³) during the months of April to September. Total hypothetical recharge during this period would constitute a 2.3 to 5.6% increase to the total recharge of the Edwards Aquifer.

6) HSIR over the city of San Antonio would hypothetically reduce pumping of the Edwards Aquifer by about 1,770 to 3,540 acre-feet/year (2.18 to 4.37 million m³/year). This is about 6-13 times less than the hypothetical volume of recharge from HSIR on an equal size portion of the aquifer's recharge zone.

13.6 Recommendations

Further studies of HSIR should focus on the specific areas discussed below. That research should utilize computer modeling of the radar-based precipitation to not only precisely measure rainfall, but to calculate ET, and to model the hydrologic characteristics of the underlying surface watersheds and groundwater recharge zones. Statistical modeling and analysis of those results would be warranted. Decisions that will be made from the results of this study should consider the water needs of communities, which were not examined in this report, and prioritize future research

and/or actual seeding for areas where water demand and the potential water yield from HSIR are both high.

13.6.1 Surface water studies

1) The impacts of HSIR on effective precipitation throughout surface water drainage basins should be further studied in the Upper Basin of the Brazos River, the Lower and Upper basins of the Colorado and Guadalupe rivers, and the Upper Basin of the Nueces River. If cloud seeding is considered in advance of further research for the purpose of increasing overall effective precipitation, it should be primarily directed at these areas.

2) The tabulated results of this study should be compared with surface water needs in the studied drainage basins and the potential for damage from stream flooding. HSIR research and implementation in the central and west Texas drainage basins listed in the previous paragraph should be prioritized based on needs and impacts.

13.6.2 Groundwater studies

1) The impacts of HSIR on recharge should be further studied in those aquifers suggested through this investigation as having the greatest potential to receive and retain recharge for human use: Edwards, Carrizo-Wilcox (excluding the Eastern and Trinity to Sulfur River segments), Trinity (excluding the Northern Segment), Edwards-Trinity, and Ogallala (Central and Southern Segments). If cloud seeding is considered in advance of further research, it should be primarily directed at these areas.

2) The tabulated results of this study should be compared with groundwater needs in the studied aquifers. HSIR research and implementation in the aquifers listed in the previous paragraph should be prioritized based on needs and impacts.

3) Detailed water budget studies are needed for the karst aquifers, especially the Edwards-Trinity, to better define the hydrology in those areas and the potential impacts of HSIR.

4) HSIR appears to be least effective in providing recharge to the Hueco-Mesilla Bolson Segment of the Alluvium and Bolson aquifers. However, given the significant need for water in the El Paso area, further research is warranted to confirm these results or to find ways to enhance them.

5) Recharge into the Ogallala Aquifer is generally low. Most occurs in playa lakes and might be enhanced by drilling recharge wells into the playa lakes to increase recharge and decrease ET. The casings from such wells should extend above the lake beds to prevent siltation in the wells.

13.6.3 Edwards Aquifer focused studies

1) Digital hydrologic models of the Edwards Aquifer should be used to study the effects of HSIR on recharge. A new model is currently under development (Geary Schindel, Edwards

Aquifer Authority, personal communications, 2001). The models should examine aquifer response to aquifer-wide HSIR and HSIR within selected drainage basins to determine which basins will allow the greatest recharge. HSIR should then be directed to those areas. The models should consider that recharge in different drainage basins will have varying effects though the aquifer, and HSIR should be applied to those where the maximum deHSIRed benefit would occur. HSIR in non-recharge zone areas to limit demand for aquifer water should be modeled to determine if conditions could be identified when the relatively small benefit of HSIR would be warranted in those areas.

2) The effect of HSIR during normal and above-normal rainfall years should be modeled to determine the potential for long-term benefits in aquifer storage and yield.

3) While HSIR over the city of San Antonio appears to produce relatively little benefit compared to HSIR over the Edwards Aquifer recharge zone, a similar comparison should be made with rainfall over cropland during the growing season when pumping for irrigation is greatest. In studying the cropland scenario, or if further study is made of HSIR over San Antonio, the maximum possible reduction in pumping should be determined to limit the extent for which the recession coefficient of equation 4 can be applied.

14.0 DETERMINATION OF THE OPERATIONAL COSTS OF CLOUD SEEDING

14.1 Introduction

The previous sections of this report have brought us to the point where it is appropriate to consider the operational costs of cloud seeding. The early sections provided information on the workings of clouds that produce precipitation and on concepts and methods to enhance their precipitation through cloud seeding. It has been noted several times that cloud seeding for rain enhancement is a complex and controversial undertaking. Nevertheless, an assessment of past randomized seeding experiments indicates that cloud seeding increases rainfall under some circumstances. Proof that cloud seeding is effective on an area basis, however, does not exist as is discussed in earlier sections of this report, although there are tantalizing "indications" that cloud seeding increases rainfall. Thus, the proliferation of operational cloud seeding programs around the world is based on an as yet unproven technology, and this is well understood by the managers of these programs. The general view in the time of great water need is that the costs of an operational cloud seeding effort are small relative to the benefits of enhanced rainfall. That being the case, it is important to quantify the costs of operational cloud seeding done in the manner necessary to realize the rainfall enhancements.

Dr. Archie Kahan, when director of the U.S. Bureau of Reclamation's cloud modification research program, Project Skywater, once remarked that, "Interest in weather modification is soluble in rain water." People are interested in rainfall enhancement when it is short supply, but lose interest when there is an ample supply. Over the years, many cloud seeding programs have been born as a result of drought. However, many (perhaps most) droughts are characterized by the presence of few clouds, or clouds that are unsuitable for cloud seeding. This means that the probability of successful cloud seeding during such times is small. If weather patterns change while such programs are ongoing, such drought-spawned projects are often locally thought

responsible for the change, and are considered successful. If the weather patterns don't change, few opportunities occur, and the project fails—not because the technology is inappropriate, but just because there are few chances to even try to apply it.

The project design plans set forth herein are not intended as a short-term means to deal with drought, but as a long-term water management tool. The impact of any precipitation enhancement weather modification program will be greatest when weather patterns are “normal”, or even on the wet side, for cloud modification does not “make” precipitation, but instead helps nature be more efficient, producing fractional increases in the precipitation received.

The project designs for a statewide seeding program presented here are all predicated upon the following:

- Certain suitable clouds can be favorably modified by the carefully executed, timely introduction of specific materials (seeding agents) not naturally present in such clouds.
- These clouds most often can be identified by straightforward means prior to treatment.
- The most certain means of delivering the seeding agent to the deHSIRed portion of the target cloud at the correct time is by aircraft.
- An assumption that cloud seeding works on an area basis and that the need is great enough to outweigh the risks involved.

14.2 Background Information

14.2.1 The hydrologic cycle

The hydrologic cycle describes all the processes involved in the movement of water throughout the hydrosphere. This includes the atmosphere (water vapor, clouds, and precipitation), the surface (oceans, lakes, rivers and streams), and the ground water (soil moisture and aquifers). There are many processes that move water among these regions, including evaporation, condensation, percolation, and evapotranspiration. Superimposed upon all this are human activities: irrigation, groundwater mining, and various urban effects, sometimes including extensive inadvertent modification of the natural atmospheric aerosols (which impact cloud development). It is thus essential that program sponsors view their cloud modification programs in the context of the entire hydrologic cycle, not just the atmospheric portion of it.

One of the most common concerns raised about cloud modification activities is their impact upon precipitation, not only within the intended target area, but also beyond, especially downwind. If one considers the complete hydrologic cycle, one comes to realize the following:

- Only a small fraction of the total atmospheric moisture is removed from the atmosphere by precipitation processes, even in the most efficient and long-lived

clouds. A large portion of the cloud condensate does not precipitate, but instead remains in the atmosphere, eventually evaporating (and sublimating) back to water vapor.

- Precipitation that falls to the surface remains part of the hydrologic cycle. Most warm season cloud seeding programs are conducted in areas that are chronically water-short, and at times when the conditions favor rapid evaporation and evapotranspiration, which quickly return a large fraction of the precipitation to the atmosphere. This increases boundary layer humidity, actually improving the chances for future convective storms. With few exceptions, most precipitation penetrates no deeper than the soils, where it remains accessible by the actively growing plant life above.
- Cloud seeding allows the atmospheric water to be utilized more fully by incrementally increasing precipitation. The impact of this immediately downwind can be clarified by asking oneself the question, “If I need rain, would I rather live downwind of (a) a rain forest (wet area) or (b) a desert (dry area).” If one understands the hydrologic cycle, the answer is (a).

14.2.2 Texas Climate

The mean annual precipitation for the Texas ranges from nearly 60 inches (150 cm) in the extreme southeast, to less than 10 inches (25 cm) in the far west near El Paso (Figure 21). The majority of the precipitation normally falls during the spring and summer months (March through August), though late season tropical storms and hurricanes have a significant impact through October.

For the purposes of this study, the State of Texas has been classified into four zones, primarily in accordance with average warm season (spring and summer) precipitation, according to Bomar (1995). These zones have been constructed to define regions that are chronically water-short, often water-short, seldom water-short, and regions that may have water shortages but most often have conditions that most often render current weather modification technology ineffective. These zones are shown in Figure 22.

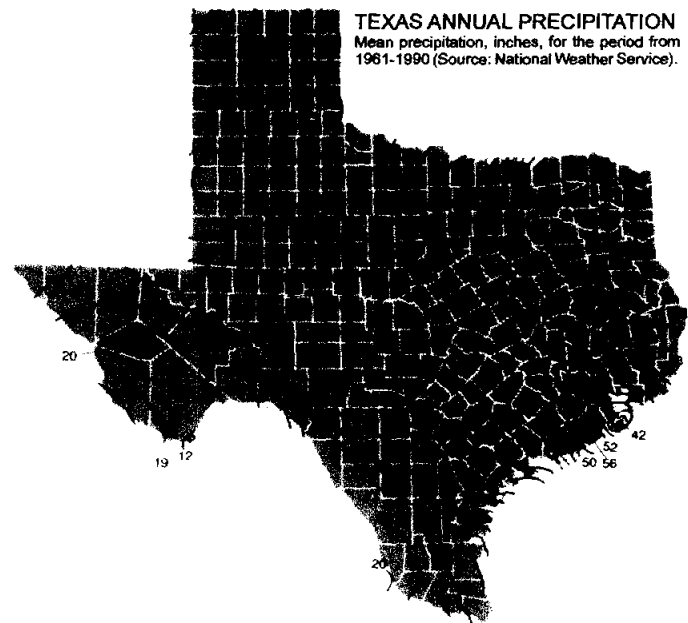

Figure 21. Texas mean annual rainfall (inches)

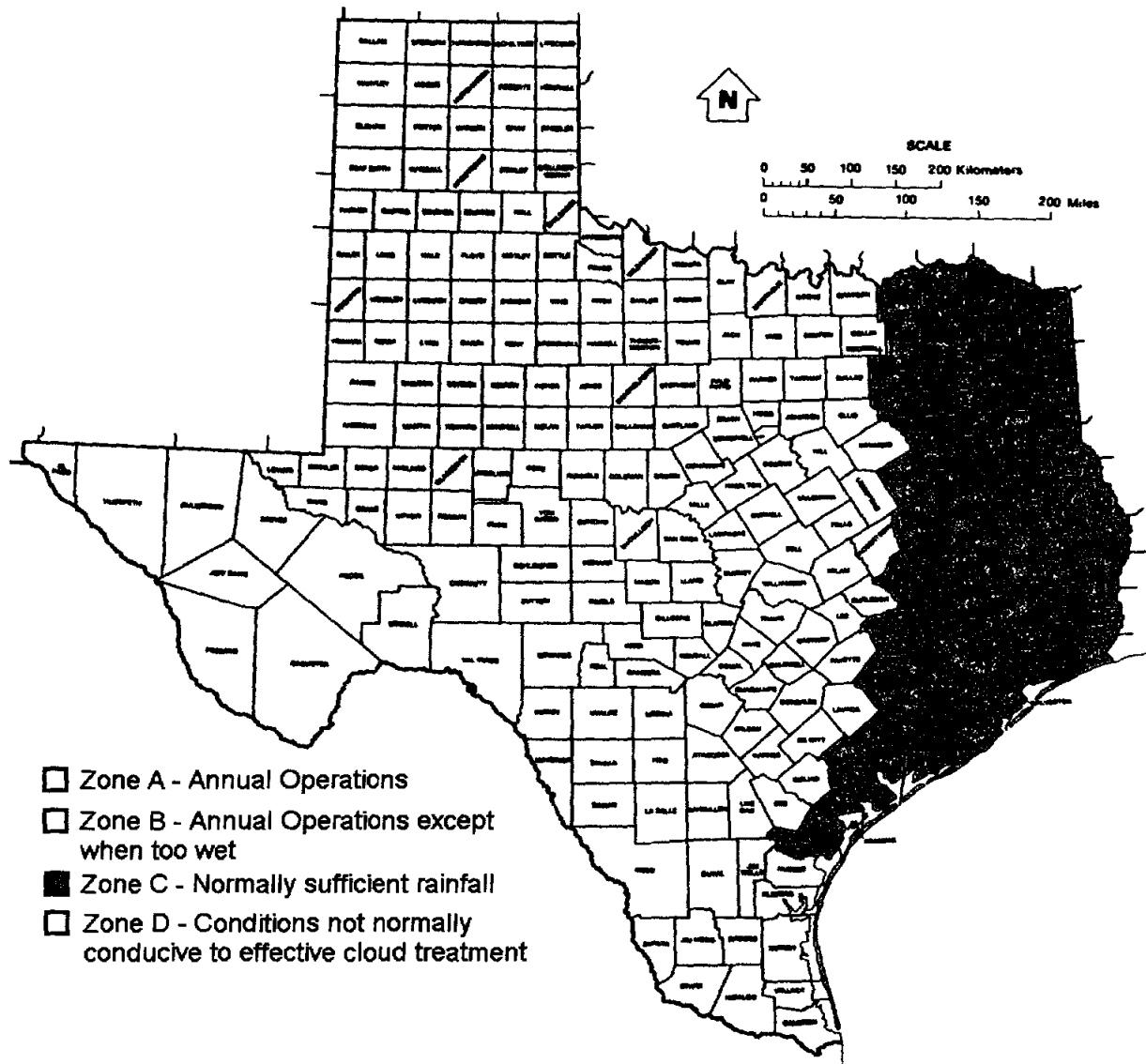

Figure 22. The four project zones, based upon average precipitation and anticipated cloud character (continental or maritime).

Zone A

Counties within Zone A are characterized by chronic water shortages, mean annual rainfall generally less than 24 inches (61 cm), and warm season convective clouds generally of continental character. Zone A reflects the portion of Texas where rainfall enhancement operations could provide continuous benefits. Programs in these areas should be designed to operate annually, at least through spring and summer, and probably into the autumn months as well.

Zone B

Counties within Zone B are characterized by frequent water shortages; mean annual rainfall generally greater than 24 inches (61 cm) but less than 40 inches (102 cm), and warm season convective clouds often of continental character. Zone B reflects the portion of Texas where rainfall enhancement operations could provide almost continuous benefit. Programs in these areas should be designed to operate every year, but will occasionally be suspended if/when weather patterns result in naturally heavy precipitation, such that soil moisture is at or near capacity, or water storage facilities (reservoirs) are at or near capacity. In drier years, benefit may also be realized during autumn months as well. In this context, annual operations are planned for Zone B as well.

Zone C

Counties within Zone C seldom suffer prolonged water shortages, having mean annual rainfall generally greater than 40 inches (102 cm). Though each year some portion of Zone C might be expected to experience periodic water shortages, such shortages will likely be infrequent enough that long-term programs would not be warranted, because in most years they would not be needed.

Zone D

The counties within Zone D are found exclusively in southern Texas, near the Gulf of Mexico. These counties receive less precipitation annually than those in Zone C, but are so near the Gulf that it is believed that most of their clouds are predominantly maritime in character, and thus not generally amenable to effective treatment. Possible exceptions would be in westerly or southwesterly flow at lower levels of the atmosphere, which could result in Mexican aerosols being transported into the region. Such aerosols have been found to produce highly continental clouds (Hernandez-Carrillo et al. 2001), which might respond favorably to hygroscopic treatment. Physical measurements of the clouds are recommended before any such attempt is made.

Seasonal Precipitation Variation

The seasonal precipitation maximum in Texas occurs in the spring and summer (Bomar 1995), but autumn also typically produces significant precipitation, largely because of periodic landfall of hurricanes and other tropical systems that bring much Gulf moisture with them. The greatest return for cloud modification programs will be realized by working during periods when opportunities will be greatest, therefore the spring and summer are the usual operational periods, though some projects currently also operate during fall months. Superposition of the map of the current (2001) Texas projects onto the four zones project zones described above is provided in Figure 23.

Diurnal Variation

Warm season convective precipitation occurs in Texas as in most other locations, primarily during the afternoons and evenings, and continuing on into the nighttime, often into the early morning hours, diminishing toward dawn. While most of the severest weather (large hail, tornadoes, and damaging winds) is produced from late afternoon until a few hours after sunset, much rainfall continues well into the nighttime. The opportunity to conduct nighttime rain enhancement operations is thus very tangible; a significant fraction of all opportunities occur after sunset and before dawn. This project design incorporates nighttime operations.

Cloud Character

Clouds are characterized microphysically as either *maritime* or *continental*. Maritime clouds possess many droplets initially larger than 15 microns, and often droplets greater than 20 microns diameter (Rogers 1976, Pruppacher and Klett 1978). Dennis (1980) notes that droplet concentrations also vary greatly, with maritime clouds having ~50 drops per cubic centimeter (cm^{-3}), and continental clouds ~500 cm^{-3} . Continental clouds possess few droplets initially larger than 10 microns, and often have mean diameters nearer to 5 microns (Rogers 1976). As discussed earlier, clouds comprised of large numbers of small droplets are said to be *continental*, because the natural aerosols that produce such clouds are found away from coastal areas, toward the

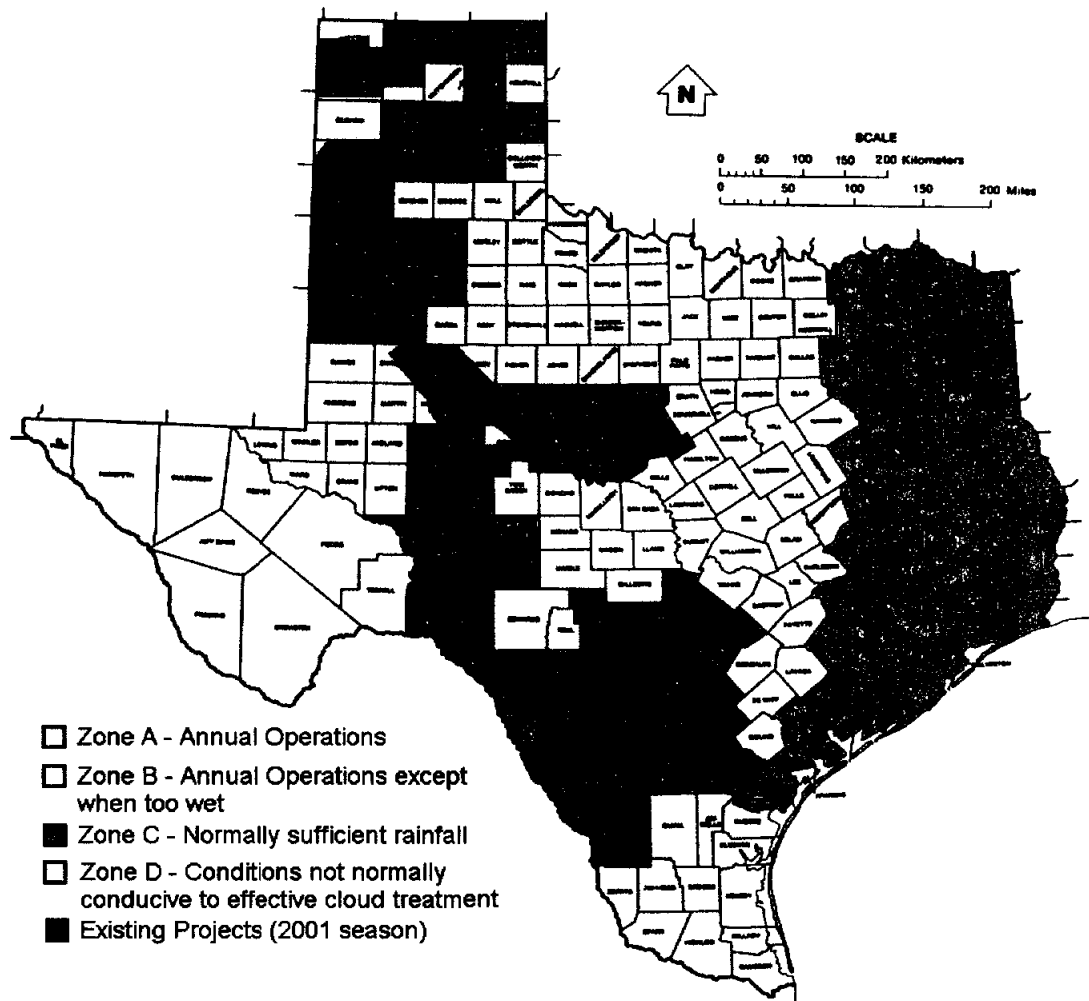

Figure 23. The rain enhancement projects superimposed on the four project

than 10 microns, and often have mean diameters nearer to 5 microns (Rogers 1976). As discussed earlier, clouds comprised of large numbers of small droplets are said to be *continental*, because the natural aerosols that produce such clouds are found away from coastal areas, toward the interiors of continents. Clouds comprised of fewer but significantly larger droplets are said to be *maritime*, because the natural aerosols that produce them are found primarily near coastal areas.

These differences arise largely because the atmospheric aerosols from which the clouds form are quite dissimilar. Coastal regions have large numbers of giant and hygroscopic cloud condensation nuclei (CCN), which result in the larger initial droplet sizes observed in the maritime clouds. Continental regions have fewer hygroscopic and giant CCN, and so initial droplet sizes are much smaller. This difference is accentuated by the fact that the higher humidities present in maritime climates result in lower convective cloud base heights, altitudes where the populations of the giant and hygroscopic are likely to be greater.

Regions farther from the coasts in general experience less humidity, and therefore higher cloud base altitudes. Though some CCN are transported upward from the surface, the continental regions have a propensity for smaller, less hygroscopic CCN, and so along with the increased cloud base heights come significantly increased cloud droplet concentrations.

Texas is characterized by both regimes. As shown clearly in the satellite climatology presented earlier, Zones A and B are characterized most often with continental clouds, while Zones C and D more often have convective clouds that are more maritime in character. Zone B may have clouds of both types, and the type observed may change on a daily basis. When moisture advection northward and westward from the Gulf of Mexico is strong, dew point temperatures may reach the 70s throughout the state, except perhaps the very far west. In such conditions, convective cloud base altitudes are likely to be relatively low everywhere (perhaps only 1,000-2,000 feet above ground level), and clouds of maritime character may develop even in the Panhandle. This having been said, however, the following should be carefully noted.

Clouds in Zone A and most often in Zone B, are continental in character and therefore may be well suited to deliberate modification by either glaciogenic or hygroscopic means. Clouds within Zones C and D may often be maritime, and therefore not suitable for either treatment, even if/when additional rainfall is desirable. In some circumstances, clouds in Zones A and B may also be of maritime character. Provisions should be made to identify such cases, infrequent though they may be, to conserve program resources. This is probably best done using the satellite methodology developed by Rosenfeld and Lensky (1998).

14.3 DEFINITION OF TARGET AREAS

Zones A and B together comprise the total proposed target area under the assumption that seeding is desired in all areas of potential need. As of the summer of 2001, there were ten independent projects conducting operations. To maximize use of existing facilities, the established radar facilities at each project site are maintained in this plan, supplemented by six additional radars. Thus, sixteen radars will be required to provide adequate target-area coverage

(Figure 24). The apparent gaps in radar coverage in southeastern New Mexico and in extreme West Texas near El Paso can be covered by radars in News Mexico when the need arises.

Each radar operations center will be staffed by two meteorologists, and accorded primary responsibility for operations over the group of counties shown. Though consideration was given to defining target areas (regions) based upon hydrology (underlying aquifers and/or surface drainage basins), the pre-existing county boundaries were chosen instead, for the following reasons.

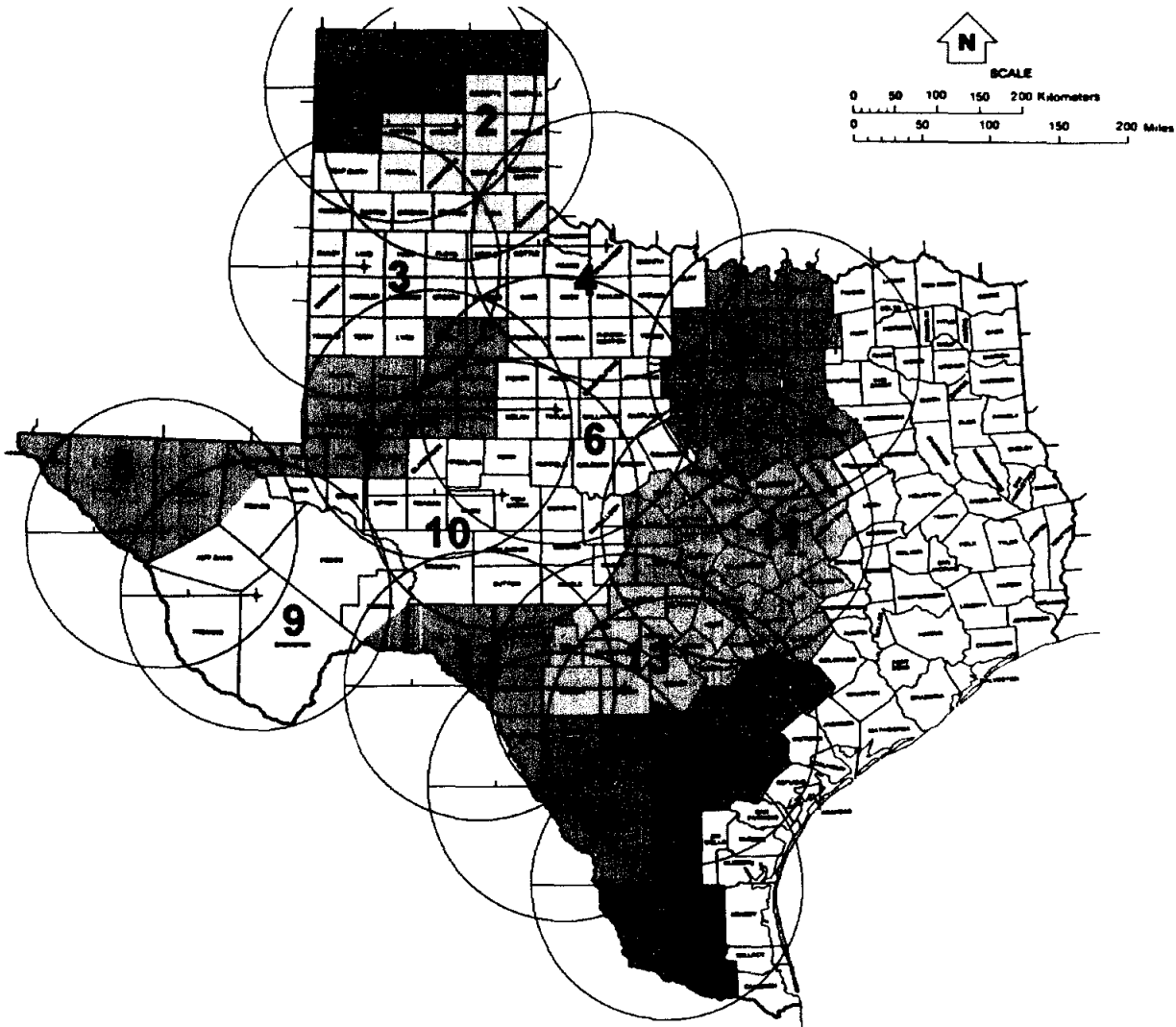

Figure 24. The placement of the sixteen project radars and their respective 100-mile (161 km, 87 nautical mile) ranges.

Table 92. Definition of Radar Operations Centers' Areas of Primary Responsibility (APRs)			
<i>AP R</i>	<i>Region</i>	<i>Counties</i>	<i>Approx. Area (mi²)</i>
1	North Plains	Dallam, Sherman, Hansford, Ochiltree, Lipscomb, Hartley, Moore, Hutchinson, and Oldham	9,600
2	Panhandle	Roberts, Hemphill, Potter, Carson, Gray, Wheeler, Randall, Armstrong, Donley, Collingsworth, Hall, and Childress	9,700
3	High Plains	Deaf Smith, Parmer, Castro, Swisher, Briscoe, Bailey, Lamb, Hale, Floyd, Cochran, Hockley, Lubbock, Crosby, Yoakum, Terry, and Lynn	14,900
4	Red River	Motley, Cottle, Hardeman, Foard, Dickens, King, Knox, Wilbarger, Wichita, Clay, Baylor, and Archer	9,300
5	Colorado River	Garza, Kent, Gaines, Dawson, Borden, Scurry, Andrews, Martin, Howard, Mitchell, Winkler, Ector, and Midland	12,700
6	West Central	Stonewall, Haskell, Throckmorton, Young, Fisher, Jones, Shackelford, Stevens, Nolan, Taylor, Callahan, Eastland, Runnels, Coleman, and Brown	15,100
7	North Central	Montague, Cooke, Grayson, Jack, Wise, Benton, Collin, Palo Pinto, Parker, Tarrant, Dallas, Erath, Hood, Somervell, Johnson, Ellis, Bosque, Hill, and Navarro	16,200
8	Far West	El Paso, Hudspeth, Culberson, Loving, portion of Reeves	10,700
9	South Pecos	Jeff Davis, Presidio, Brewster, Ward, Crane, Pecos, portions of Reeves, Terrell	22,400
10	West	Glasscock, Sterling, Coke, Upton Reagan, Irion, Tom Green, Concho, McCulloch, Crockett, Schleicher, Sutton, Menard, Kimble, and portion of Mason	17,700
11	Central	San Saba, Mills, Hamilton, Lampasas, Coryell, McLennan, Bell, Falls, Limestone, Robertson, Milam, Williamson, Burnet, Llano, Travis, Lee, Bastrop, Burleson, Fayette, and portion of Mason	17,000
12	Texas Border	Val Verde, Edwards, Kinney, and Maverick	8,200
13	Edwards	Gillespie, Blanco, Hays, Caldwell, Guadalupe, Comal, Bexar, Kendall, Medina, Uvalde, Real, Kerr, and Bandera	11,400
14	Southwest	Zavala, Dimmitt, Webb, and La Salle	7,300
15	South	Frio, Atacosa, McMullen, Live Oak, Karnes, Goliad, Bee, Wilson, DeWitt, Gonzales, and Lavaca	9,900
16	Far South	Zapata, Jim Hogg, Brooks, Duval, Starr, and Hidalgo	7,700

Counties are political subdivisions, and their residents are familiar with their boundaries and local political processes. When primary operational areas are defined by county boundaries, it becomes much easier to include or exclude areas (counties) as local sentiment deHSIRes. In three instances (Mason, Reeves, and Terrell counties), the counties are divided between two regions to facilitate the geometry and optimize radar coverages. Each regional group of counties, to be served by centrally sited radar, is collectively designated as an Area of Primary Responsibility, or APR. The sixteen operational areas are described in greater detail in Table 92.

Overlap of radar coverages is very significant in many cases, and the combined total target area could be covered with fewer radars should some presently sited radars be moved. However, there is value in having some redundancy in coverage. When a radar becomes inoperable, coverage may be provided by a neighboring set while repairs are made. Radar data are also collected for evaluation purposes, so some overlap in coverage affords an increased likelihood of recording untreated control clouds, if not for the immediate APR, then for a neighboring one. In addition, the existing radar sites reflect the presence of strong local interest in cloud seeding efforts. This support would be more likely to remain undiluted if the radars stay where they are; a local sense of ownership helps sustain these programs.

In proposing the six additional radar sites, topography has been examined, but personal visits to each location to select the best radar site have not been made. It is presumed that commercial, 120-volt power is available at each, for all are to be placed near cities or towns. Three-phase power is not required for these C-band weather radars.

Each radar will be equipped with a Radar Data Acquisition System (RDAS). The processed data stream from each RDAS will be ingested and processed by Thunderstorm Identification, Tracking, Analysis, and Nowcasting (TITAN) software (Dixon and Weiner 1993). Flight telemetry data will be ingested and displayed in real-time on the TITAN console, providing the operations center meteorologists with the requisite decision-making information. The TITAN software is occasionally updated, and it is thus important that all of the regional radars be running the same version.

Two different aircraft tracking systems are readily available, and presently in use in Texas. A system developed by ESD (Electronic Systems Development) is interfaced directly with TITAN. Another system developed by WMI (Weather Modification, Inc.) telemeters the aircraft data to a ground computer where it is displayed independently of TITAN, and also is ingested and displayed on TITAN. Both systems provided GPS-based aircraft position and seeding events. The WMI system requires an additional computer in the radar, but also displays aircraft position even if TITAN is down or the radar inoperative. Either system is satisfactory.

It is advantageous for project radars to be co-located with project aircraft, for the pilots can see firsthand where existing echoes are developing prior to takeoff. This initial knowledge provides them with a greater perception of the initial conditions. After missions, the flight crews can also sit down with the meteorologist and review the entire storm event, volume scan by volume scan. Both air and ground personnel benefit from such exercises, the pilots learning what the meteorologist sees (and does not see) with the radar, and the meteorologist gets a verbal

recounting of the flight events. When radars are sited any distance from the airports, this essential interaction and camaraderie is impaired significantly.

14.4 Seeding by Aircraft

Aircraft seeding is by far the most direct and certain means of targeting convective clouds, whether treatment is glaciogenic, hygroscopic, or a combination of the two. For most operations, especially in Zone A and the northern portions of Zone B, treatment will most often be with glaciogenic agents. Since the purpose of glaciogenic treatment is to freeze (glaciate) supercooled portions of developing clouds, the seeding agent must, by definition, reach the supercooled portions of the clouds.

14.4.1 Glaciogenic treatment

There are two ways in which the glaciogenic agents can be delivered to the subject cloud towers. The first and most direct is to place the requisite agent directly within the cloud tower itself, just as the tower grows tall and cold enough for the seeding agent to be effective (called *top seeding*). The second is to release the seeding agent into updrafts below the rain-free cloud bases of growing cumulus congestus turrets, or towering cumulus (called *base seeding*).

With base seeding, the updraft is used to transport the glaciogenic agents aloft, to the supercooled portions of the cloud top, where ice development then initiates. Updrafts within developing cumulus typically range from 5 to 10 m s⁻¹. The distance from cloud base to supercooled cloud top varies daily, depending upon atmospheric temperature and moisture content, but will typically be on the order of 4 km (about 12,000 feet). Even with the more vigorous clouds, at least six to seven minutes will be required to transport the seeding agent from below base to the supercooled regions, and this only if the updraft is sustained. The rate of cloud top growth is generally somewhat less (except in vigorous turrets adjacent to strong thunderstorms), perhaps on the order of 1,000 feet per minute (5 m s⁻¹). Still, this means that for the seeding agent to arrive at cloud top just as the cloud top becomes supercooled enough to active the ice nuclei (-5°C or colder), treatment must begin below base when the respective cloud top is no taller than 12,000 – 13,000 feet. The updraft of a cloud turret initially 18,000 feet tall (with a cloud top temperature of ~ -10°C) will in the best case deliver seeding agent to sufficiently supercooled cloud regions only when the cloud top has grown to perhaps 23,000 feet and -15°C, and ice may have already begun to form naturally. In such cases the advantage in precipitation development gained by seeding is largely lost. Base seeding is normally conducted in visual flight rules (VFR) conditions.

This is pointed out not to discourage base seeding, but to *encourage* base seeding below *smaller* cloud turrets which, at the time of treatment, are not yet close to producing supercooled cloud tops. The minimum 6 to 7 minute delay from time of initial cloud base treatment to first ice development highlights the advantage of cloud top glaciogenic treatment, whenever it is both practical and safe to do so. Note also that for hygroscopic seeding, cloud base treatment is the *only* option (see Hygroscopic section following).

Glaciogenic treatment from cloud base is accomplished either by burning pyrotechnics held in place in racks mounted to the trailing edges of the wings, or by the combustion of seeding solutions within ice nuclei generators, usually affixed to the aircraft near the wing tips. Additional information on seeding agents is provided later.

Top seeding, while being more direct and having an immediate impact, also generally requires an aircraft of somewhat higher performance. Treatment altitudes are always above 12,000 feet altitude, therefore Federal Aviation Administration (FAA) regulations require either pressurized aircraft, or that the flight crew use oxygen. The additional aircraft performance provides a bonus in the form of faster responses to seeding opportunities, and a greater effective radius of operations. Another advantage to top seeding is that the subject clouds are actually penetrated, and first-hand information about cloud temperature, liquid water content, updraft, and ice content can be obtained. The decision to seed or not seed can then be made accordingly. Even without specialized instrumentation, qualitative measurements can be made. Liquid water and temperature can be determined by how much and how quickly airframe icing occurs. Updraft can be sensed by the "seat of the pants", the accelerations felt first-hand by the pilot, as well as the rate of climb indicator and/or vertical velocity indicator (VVI). The detection of natural ice without instrumentation requires slightly more discernment, but can usually be accomplished by listening carefully during penetration for the telltale "clicks" of hard (ice) hydrometeors on the windscreen. In convective clouds, ice-phase precipitation usually first appears in the form of graupel (soft irregular snow pellets). Though initially small, graupel produces audible sounds when impacting the aircraft.

Glaciogenic treatment from cloud top may be accomplished in several ways. Pyrotechnics (Figure 25) may be ignited and ejected from racks affixed to the lower portion of the fuselage. In similar fashion, dry ice (carbon dioxide, CO₂) pellets may also be dispensed into supercooled cloud. As in base seeding, other pyrotechnics (Figure 26) may be held in place in racks mounted to the trailing edges of the wings while the aircraft penetrates the subject cloud turrets, treatment may also be accomplished by the combustion of seeding solutions within wing tip mounted ice nuclei generators. Ejectable flares are most commonly used for top seeding and are the focal point for the project design presented herein.

Because cloud penetration is involved, aircraft operating on top are required to obtain instrument flight rules (IFR) clearances from an Air Route Traffic Control Center (ARTCC) before engaging in operations.

14.4.2 Hygroscopic treatment

While glaciogenic seeding is designed to accelerate the cold-cloud precipitation formation process by initiating ice development sooner than it would otherwise naturally occur, hygroscopic seeding has an entirely different objective. Maritime clouds contain relatively large cloud droplets, which with time grow to precipitation sizes through collision and coalescence. However, if the cloud is continental, there will be many, many, more droplets, but they will all be very small. Continental clouds that do not grow tall and cold enough to result in ice formation naturally are destined to collapse without producing any precipitation, for their very small droplets are not suitable for the development of precipitation through collision and

coalescence. However, if the sizes of the cloud droplets in such clouds are increased, the cloud character is made more maritime, and the cloud as a whole thus becomes much more conducive to precipitation development by collision and coalescence (e.g. Mather et al., 1996).

Cloud droplets first form as moist air rises and cools, eventually reaching an altitude where a brief supersaturation occurs. It is at this critical location and time that the cloud character (maritime or continental) is established, depending upon the available natural aerosols, specifically, the natural cloud condensation nuclei. If the cloud is to be modified by changing this initial character, treatment must occur at cloud base, with agents that will encourage the formation of large cloud droplets. Such agents, which attract water, are said to be *hygroscopic*.

Hygroscopic treatment of continental clouds is best done through the use of special pyrotechnics comprised of simple salts (and oxidants, to produce a combustible mixture). Typically, such flares are about 1 kilogram mass, and comprised largely of calcium chloride (CaCl) or potassium chloride (KCl). Flares of these characteristics have been manufactured in France, and more recently in North Dakota. Typically, one flare is burned in updraft beneath each targeted turret. Because the flares are considerably more massive than other conventional burn-in-place flares, not all flare racks are suitable for their use. If full racks are to be carried, reinforcement and/or redesign may be necessary.

While there is great potential for hygroscopic treatment of continental clouds, hygroscopic treatment is initially proposed only on an experimental basis, to determine when and where such treatment will prove most effective.

14.5 Glaciogenic Seeding Agents

This document is intended as a guide for the development of a larger, more effective rainfall enhancement program for the State of Texas, and as such, offers no specific endorsements or recommendations as to brand names or specific seeding agent vendors. However, the seeding agents are mission-critical, and their selection cannot be taken lightly. In selecting seeding agents, the following guidelines are offered. A wide number of formulations for pyrotechnics and solutions have been proposed and used. Effectiveness is usually judged by the following criteria:

- The number of functional ice nuclei produced, per gram of silver iodide burned or per gram of pyrotechnic burned.
- The activation temperature of the majority of the nuclei thus produced (In other words, how cold does the cloud have to become before ice will form?)
- The speed with which the ice nuclei become active.
- The mechanism through which nucleation occurs. Does nucleation occur only by contact, or by condensation-freezing?
- Cost.

14.5.1 Seeding solutions

Seeding solutions are burned in airborne ice nuclei generators, as described previously. The solutions are comprised primarily of acetone, which is mixed with silver iodide, and/or ammonium iodide, paradichlorobenzene, sodium perchlorate, ammonium perchlorate, and water. The products of combustion are the silver iodide-silver chloride-salt ice nuclei, which function in a condensation-freezing mode (e.g. DeMott 1997), carbon dioxide, and water.

The seeding solution formulations presently being used in Kansas, North Dakota, Texas, and Oklahoma are all similar, and have all performed well in laboratory tests. All function by the condensation-freezing mechanism, and yield approximately 10^{14} ice nuclei per gram of silver consumed. Activation times are likewise relatively fast.

Whether procuring the components individually and then mixing them on site, or purchasing the solution mixed, it is essential that only quality ingredients be used.

14.5.2 Glaciogenic Pyrotechnics



Figure 25. A 20 mm diameter, 20 g yield glaciogenic, ejectable cloud seeding pyrotechnic.

Figure 26. A 20-mm diameter, 40-g yield glaciogenic, burn-in-place cloud seeding pyrotechnic.

The burn-in-place flare (BIP, Figure 26) is, as its name implies, burned while held in place, attached to the aircraft, and is used

Glaciogenic pyrotechnics (Figure 24), or flares, are manufactured in two forms. The ejectable form is fired from a downward-pointing rack mounted to the belly of the seeding aircraft. The flares are housed in aluminum casings, which remain attached to the aircraft, only the flare candle, ignited, falls into the cloud. Because the candle burns in free-fall within the cloud for roughly 4,000 to 5,000 feet before being consumed, it is important that such flares be fired only at or near cloud top, and that other aircraft are not operating within that distance directly below. The industry standard for ejectable pyrotechnics is 20 grams.



while flying in updrafts at cloud base. The BIP flares are manufactured in a wide variety of sizes, from 40 grams up to 150 grams.

The BIP and ejectable flares are usually made using the same formulation (by each manufacturer). As is the case with seeding solutions, care must be taken to obtain quality products. The following standards are strongly recommended:

- Test results from a nationally recognized independent test facility (such as the CSU SimLab) should be obtained for each formulation to be used, prior to use.
- A small random sampling of each large shipment should be selected for field testing upon receipt from the manufacturer. A few BIP flares should be tested for ignition, burn time, burn characteristics, and residue. Likewise, ejectable flares should be tested for firing and ignition of the candle itself, by overflight of the runway several thousand feet above the ground, at night, to confirm ignition as well as ejection. Problems will thus be identified early.
- All flares should bear the manufacturer's identifying mark, as well as a lot number and/or date of manufacture that would make it possible to isolate flares from the same lot/date, in the event a problem is identified.
- Manufacturers should be selected which are insured and bonded, and which will replace any defective product (duds, misfires).

14.6 Hygroscopic Pyrotechnics and Sprays

If hygroscopic seeding is to be conducted, pyrotechnics are by far the most cost-effective way to do it, although Rosenfeld and Woodley (personal communication, 2001) are now arguing that hygroscopic seeding with a brine spray may prove to be more effective. Hygroscopic flares should be subjected to the same standards as glaciogenic flares (above).

14.7 Seeding Equipment

Seeding equipment is available from several sources. Outwardly, the physical appearance varies little, and operating principles are the same, regardless of source. The primary concerns are of course functionality and reliability. Whether leasing or purchasing the equipment, the provider ought to be willing to provide assurances that, if properly maintained, it will perform dependably. Recently, some equipment manufacturers have redesigned some of the older "industry standard" equipment, so



Figure 27. A wing rack of twelve 1 kg (1,000 g) yield hygroscopic cloud seeding flares. Each cloud turret is treated with a single flare, burned in updraft below cloud base.

though equipment of a given type (wing tip generators, for example) may look the same, they may not be.

14.7.1 Wing-tip generators

Wing-tip ice nuclei generators are built in two forms. One, a design pioneered by Ora Lohse, uses ram air to pressurize the generator and force the seeding solution from the generator tank into the combustion chamber. Flow rates vary depending upon air speed. This generator, in a radically redesigned form, is presently only used in North Dakota. The second, more common design, uses a pressurized air tank to induce flow of the seeding agent. This design, credited to William Carley, is used widely for cloud base seeding operations. Though some care and preventive maintenance is required, the wing tip generator is a very cost-effective means of treating convective cloud from below cloud base (Boe and DeMott 1999).

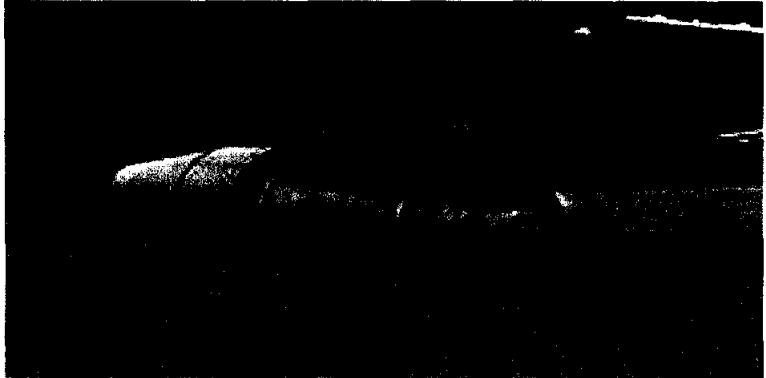

Figure 28. A Carley-type wing-tip ice nuclei generator for glaciogenic seeding in updraft below convective cloud base. Shown here is the WMI mounting below the wing-tip of a Cessna 340.

Wing-tip generators are well suited to rainfall enhancement work, as they burn the seeding agent more slowly than pyrotechnics, typically releasing 2-3 grams per minute continuously over long periods, at relatively low cost. If well maintained, the wing-tip generators can be reliably turned on and off repeatedly during long missions.

14.7.2 Burn-in-place flare racks

Burn-in-place flare racks are available in 12-position, 14-position, and 24-position versions. The larger numbers are used in conjunction with smaller (40 g) flares, whereas the 12- and 14-position racks are used with hygroscopic and/or 150 g flares (see Figure 26).

14.7.2 Ejectable flare racks

Racks for ejectable flares are affixed to the seeding aircraft beneath the fuselage. Each rack typically holds three rows of 34 ejectable flares, which are fired electronically, in sequence, by command from the cockpit. If desired, multiple ejectable racks can be mounted on an aircraft, thus enabling the treatment aircraft to remain on station longer in active weather situations. However, having



Figure 29. A belly-mounted 102-position rack for ejectable 20 mm, 20 gram glaciogenic pyrotechnics.

racks can be mounted on an aircraft, thus enabling the treatment aircraft to remain on station longer in active weather situations. However, having multiple flare "baskets," the metal framework that supports the flares against the firing mechanism is just as important as having multiple flare racks. The baskets are attached by two bolts, which can be quickly removed with a speed-wrench, so considerable time can be saved if a second, pre-loaded basket is available for quick swaps between missions.

14.8 Facility Deployment

The Texas programs in existence at the time of this report have already acquired and deployed many aircraft, and also ten weather radars. The radar locations (and others proposed) are shown in Figure 23. Because the existing programs are, with few exceptions, acting as independent entities, each has attempted to deploy the aircraft it believes are necessary to do the best job that can be afforded.

In the context of this plan, the individual Areas of Responsibility (APRs) are instead treated as a whole. This means that although aircraft are based within each APR, their operations are not limited only to that area. Because weather systems generally move in a more-or-less predictable progression, fewer aircraft can be deployed, with the understanding that each may conduct operations in APRs adjacent to that in which each is based. Some infrastructure must first be set forth in order for this arrangement to function effectively, as enumerated below:

- All seeding agent will be obtained from a common supply (procurement), and distributed among the aircraft as needed.
- Aircraft data systems will provide records of where each seeding action was taken. Billing for seeding agent expended will be determined by the location of expenditure, not aircraft basing.
- Individual operations centers in each APR will routinely coordinate their activities with adjacent APRs. For example, if a weather system being treated over the High Plains (APR 3) is moving southeastward, Colorado River (APR 5) operations will offer the use of aircraft based in their APR to the High Plains controllers, with the knowledge that these aircraft will work their way back into their assigned APR. Likewise, aircraft from the High Plains might continue working the system as it moves into the Colorado River APR, if needed.
- All aircraft communications frequencies shall be coordinated, so that aircraft moving from one APR to another know what frequencies to monitor, and which to use to contact other operations centers.
- Each operations center shall direct seeding operations in its own APR, regardless of where the aircraft originated. This concept is analogous to the way the Federal ARTCC system functions, e.g., when in Albuquerque air space, the pilot communicates with Albuquerque Center, when in Fort Worth airspace, with Fort Worth Center.

- Plans for cloud top operations to be conducted near adjacent APRs will be conveyed to the adjacent APR, so that the requisite IFR clearances can be obtained with minimum conflict, in the event the other APR is also contemplating cloud top operations.

Each APR has a certain number of aircraft assigned to it, depending upon its area, proximity to other regions, the number of adjacent areas that also have available aircraft, and whether or not it is on an upwind side of the greater project area, e.g., whether or not it has the responsibility for the initial response to those clouds first moving into the state (Table 93). These "initial response" regions, from north to south, are: North Plains, High Plains, Colorado River, Far West, South Pecos, Texas Border, Southwest, and Far South. Clouds may develop within the regions, or upwind of them. Only the "initial response" regions must deal with both, the other regions will for the most part only be dealing with clouds that develop within their borders, or with those leaving (and therefore previously treated by) other regions. It is this latter consideration that is of concern here; aircraft from two APRs may attempt to work the same cloud system if a coordinated hand-off of operations does not occur.

14.9 Aircraft Requirements

As previously mentioned, seeding may be conducted either from cloud base, or at cloud top. Cloud top seeding aircraft are pressurized, and in general of greater performance than those needed for cloud base work, primarily because they must not only reach the subject clouds quickly, they must also climb to cloud top (typically ~ 18,000 feet) while doing so. Cloud base aircraft require less performance. The minimum recommended requirements are as follows:

14.9.1 Cloud Base Aircraft Requirements

- **Twin engine.** This requirement is set forth for two reasons. First, the faster the airplane, the shorter the response time, and the more clouds that can be treated with a single aircraft. More importantly, in the event of engine failure, a single-engine aircraft must descend, without power. If this should happen while engaged in seeding activities beneath convective cloud base (probably with a mature thunderstorm somewhere nearby), the situation may be quite serious. Far worse still, if an engine failure should occur at night, the flight crew is faced with a no-power descent in the dark near a thunderstorm. Though single-engine aircraft can be effectively used for cloud-base seeding, their selection will likely lead to fewer nighttime missions being flown, in large part because experienced pilots wish to avoid the situation mentioned above. (This fact is usually not stated directly by the pilots, but comparisons of the diurnal distribution of seeding times for single-engine and for multi-engine aircraft will clearly show the difference, especially when the pilots-in-command are experienced.) A significant fraction of all seeding opportunities occur at night, nearly half in some seasons. Over the years, the second engine has brought many twin-engine seeding aircraft safely home in the dark.
- **Instrumentation required for IFR flight.** Though the vast majority of cloud base seeding operations are conducted in visual meteorological conditions (VMC), the nature of the missions is to flirt continuously with thunderstorms, within an active convective

environment. Sooner or later, flying a short IFR (instrument flight rules) leg to get out of a tight situation, or to get to the subject cloud mass faster, is required. In addition, cloud development can be rapid and unexpected, and aircraft can sometimes just get caught in deteriorating conditions. An IFR-instrumented aircraft is mandatory.

14.9.2 Cloud top aircraft requirements

- Twin engine, as above, but normally with more performance than those used primarily at cloud base. These aircraft will have a shorter response time, as well as a greater rate-of-climb.
- Instrumentation required for IFR flight. Cloud penetrations are routine, so the aircraft must be IFR.
- Certified for flight in known icing conditions, and fully deiced, including wings, tail, windscreen, and propellers. Penetration of supercooled cloud is a certainty, so the aircraft must be able to carry some ice, and also of shedding it when it accumulates.
- Radar Equipped. Functional on-board weather radar is essential. Color optional.
- Pressurized. Flight is maintained at altitudes above 12,000 feet for extended periods, therefore either pressurization or oxygen is required. Pressurization is much easier, for the crew does not have to deal with oxygen masks throughout every flight.

Aircraft speed is also very desirable, especially during the “dash” from the airport to the cloud field of interest. Seeding in updrafts below cloud base is actually often conducted at less than full cruise speed; the idea being to get as much seeding agent into the updraft as possible. Cruise in level flight should be as fast as practical, ideally not less than 200 miles per hour (174 knots), in order to minimize response times. Slower aircraft can certainly be used, but only at the cost of increased response times and missed opportunities (see Figure 29).

The aircraft selected for cloud base operations in this plan is the Piper Seneca II, a mid-range, medium performance light twin, with a proven weather modification track record. The Seneca II has a manufacturer’s rated cruise speed of 225 mph (195 knots), and an all-engine maximum rate of climb of 1,200 feet per minute. The aircraft is not pressurized. Radar is available as an option, but not considered essential for cloud base seeding.

Table 93. Assignment of Aircraft by Areas of Primary Responsibility (APRs)							
<i>APR</i>	<i>Region</i>	<i>Initial Response ?*</i>	<i>Area (mi²)</i>	<i>Seeding Aircraft (by ID)</i>		<i>Aircraft Base(s)</i>	<i>Radar Location*</i>
				<i>Cloud Top</i>	<i>☉Cloud Base</i>		
1	North Plains	Yes	9,600	☉Alpha Bravo	☉Seed1 ☉Seed 2 Seed 3	Dumas	Dumas*
2	Panhandle	No	9,700	Alpha ☉Bravo Charlie	Seed1 Seed 2 ☉Seed3 Seed 6	Pampa, Panhandle	White Deer*
3	High Plains	Yes	14,900	Bravo ☉Charlie ☉Delta Echo Fox Gulf	Seed3 ☉Seed 4 ☉Seed5 Seed 6	Plainfield	Plainfield*
4	Red River	No	9,300	Bravo ☉Echo Charlie Delta Hotel Indigo	Seed3 Seed 4 Seed5 ☉Seed 6 Seed9 Seed 10	Wilbarger	Wilbarger
5	Colorado River	Yes	12,700	Charlie Delta ☉Fox ☉Gulf Hotel November	Seed4 Seed 5 ☉Seed7 ☉Seed 8 Seed9 Seed 15	Big Spring, Odessa- Schlemeyer	Big Spring*
6	West Central	No	15,100	Echo Fox Gulf ☉Hotel Indigo November Oscar	Seed6 Seed 7 Seed8 ☉Seed 9 Seed10 Seed 15 Seed 16	Abilene	Abilene*
7	North Central	No	16,200	Echo Hotel ☉Indigo Oscar	Seed6 Seed 9 ☉Seed10 Seed 16	Mineral Wells	Fort Worth
8	Far West	Yes	10,700	☉Juliet ☉Kilo Lima Mike	☉Seed11 ☉Seed 12 Seed13 Seed 14	Van Horn, West Texas (El Paso)	Van Horn

9	South Pecos	Yes	22,400	Juliet Kilo ⊛Lima ⊛Mike November Papa	Seed11 Seed 12 ⊛Seed13 ⊛Seed 14 Seed15 Seed 17	Marfa, Alpine	Alpine
10	West	No	17,700	Fox Gulf Hotel ⊛Novemb er Lima Mike Oscar Papa	Seed7 Seed 8 Seed9 Seed 13 Seed14 ⊛Seed 15 Seed16 Seed 17	San Angelo	San Angelo*
11	Central	No	17,000	Hotel Indigo November ⊛Oscar Quebec Sierra	Seed9 Seed 10 Seed15 ⊛Seed 16 Seed18 Seed 20	Draughon- Miller (Temple)	Killeen
12	Texas Border	Yes	8,200	Lima Mike November ⊛Papa Quebec Romeo	Seed13 Seed 14 Seed15 ⊛Seed 17 Seed18 Seed 19	Del Rio	Del Rio*
13	Edwards	No	11,400	Oscar Papa ⊛Quebec Romeo Sierra	Seed15 Seed 16 Seed17 ⊛Seed 18 Seed19 Seed 20	Hondo, New Braunfels	Hondo*
14	Southwest	Yes	7,300	Papa Quebec ⊛Romeo Sierra Tango	Seed17 Seed 18 ⊛Seed19 Seed 20 Seed 21	Dimmitt Co. (Carrizo Springs)	Carrizo Springs*
15	South	No	9,900	Quebec Romeo ⊛Sierra Tango	Seed18 Seed 19 ⊛Seed20 Seed 21	Pleasanton	Pleasanton*
16	Far South	Yes	7,700	Romeo Sierra ⊛Tango	Seed19 Seed 20 ⊛Seed 21	Hebbronville	Hebbronville

**Initial Response APRs are those upwind of which no seeding programs are operational.
 ⊕ indicates aircraft is based in APR shown, but may shared with others
 radar is presently operational at location shown

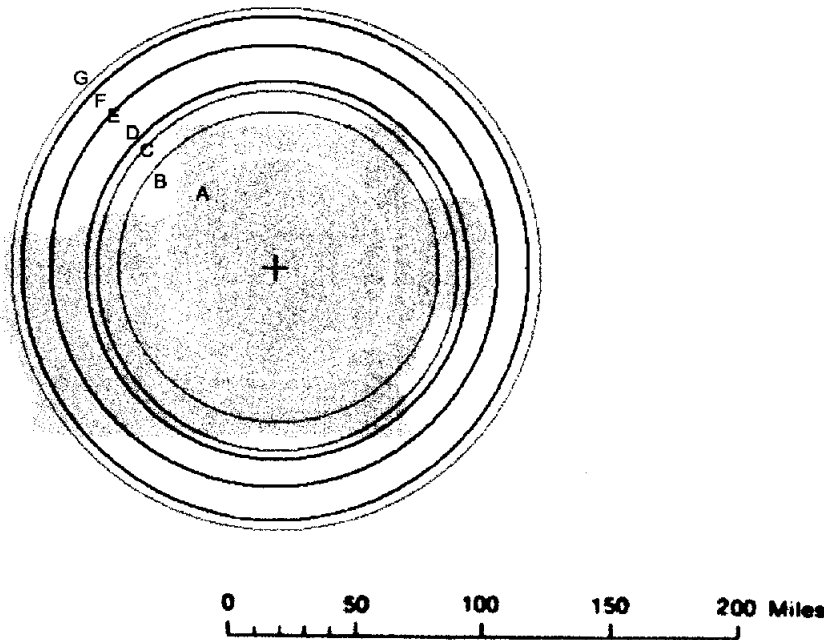

Figure 29. A hypothetical target area (gray), with airport and radar cited at central “+”. Circles shown depict the maximum ranges attainable for a variety of aircraft, assuming 20 minutes cruise climb from time of takeoff. Speeds depicted are from manufacturer’s specifications; actual speeds when rigged for cloud seeding operations will be less. Aircraft types are as follows: A-Cherokee 140, B-Single Comanche, C-Turbo Aztec, D-Seneca II, E-Cessna 340, F-100 mi radar range ring, and G-Cheyenne II turboprop.

The aircraft selected for cloud top seeding operations is the turbocharged, Ram Cessna 340, a mid-range, medium performance, pressurized light twin, also proven reliable for weather modification operations. The Ram Cessna 340 has a cruise speed of 263 mph (228 knots), and a maximum rate of climb of 1,650 feet per minute. The faster rate-of-climb ensures the aircraft can reach seeding altitude relatively quickly. The aircraft is pressurized, and available equipped for known icing conditions. The Cessna 340 also is radar-equipped, an essential feature for cloud-top seeding operations.

14.9.3 Aircraft interactions

The project aircraft assignments are listed by APR in Table 93. Aircraft will be sharing airspace and target areas, and there will likely be a need for one centrally located clearinghouse of project status reports, so each seeding aircraft shall be given a unique identifier. Cloud top seeding aircraft are to be prefaced with the word “Storm”, and cloud base aircraft with the word “Seed”. The identifiers for the cloud top aircraft will be the phonetic alphabet, common to aviation. The identifiers for the cloud base aircraft will be sequential numbers. Thus, the cloud base and cloud top aircraft will always be easily differentiated in reports and in radio communications.

The cloud top aircraft will be equipped with wing-tip generators, and so will be able to operate at cloud base also. It is proposed that when this occurs, the "Storm" nomenclature be changed to "Seed", while the aircraft is operating VFR at cloud base, to alert other base seeding aircraft that another aircraft is "in the mix". For example, Storm Bravo will thus be the IFR (cloud top) identifier of the Cessna 340 based in the Panhandle APR, but if/when that aircraft operates at cloud base, it will communicate with other aircraft as Seed Bravo.

This nomenclature will provide unambiguous identification of all project aircraft at all times; there will be only one aircraft by each name, not a "Seed 1" in every program.

14.10 Personnel

The personnel needed to conduct weather modification operations fall into three categories: aviation (pilots), meteorologists, and technicians. All three must be proficient if a project is to be successful.

14.10.1 Pilot qualifications

The modification of convective clouds by definition requires flight in close proximity to active deep convection, a.k.a. thunderstorms. From the first day a pilot-to-be begins ground school for their private pilot's license, they are told that thunderstorms are dangerous, and should always be avoided (typically by 20 miles, at least). These warnings are given for good reasons. Convective storms possess (or may possess) all of the following hazards: lightning, hail, extreme wind shear (both vertical and horizontal), icing, and microbursts. Combine any of these with instrument meteorological conditions (IMC), which require IFR flight, and one has flight conditions that will test the mettle of even the most experienced, seasoned pilots.

Safe flight in proximity to convective storms requires the pilot to have a functional knowledge not only of flying and of the aircraft, but also of thunderstorms. The latter is not taught as part of any conventional flight school, but is instead obtained only by flight experience, ideally on weather modification programs with other experienced pilots-in-command. Obviously, the pilot must also be insurable in the aircraft type they are to be flying. In general, the more complex the aircraft, the more hours the pilot must possess to be found insurable.

The pilot pool from which such experienced pilots might be hired is limited, largely because the commercial airlines in America have in recent years been hiring in large numbers. This creates competition between the weather modification industry and the airlines, a competition most of the time won by the airlines. (After all, most pilots don't become pilots to fly around thunderstorms; they do it with the aspirations of ultimately becoming captains on large commercial jetliners.) The result is that, with few exceptions, most weather modification pilots fly weather modification only long enough to log sufficient multi-engine hours to gain the interest of the airline industry. For most, this takes only a few years. The allure of weather modification is further diminished by its seasonal nature. Except for those pilots hired by commercial weather modification contractors, most work only four to six months and are then left to find other employment for the balance of the year.

However, the experienced weather modification pilot is an invaluable and indispensable commodity. It is the pilots who ultimately make all the treatment decisions, not the meteorologists on the ground. Ultimately, then, it is the pilots who make or break even the best-designed and equipped programs.

The program set forth herein is designed with effectiveness in mind. The large number of aircraft suggested is realistically needed, given the vast area to be covered and the 24 hours-a-day, seven-days-a week (24-7) intent of the program. Single engine aircraft are not proposed for the safety and performance reasons previously cited. An argument might be made that single engine aircraft are less expensive to operate, and that one could just launch sooner to make up for the lack of aircraft performance. However, this ultimately fails to a significant degree because of the unpredictable nature of the development of convective clouds. In other words, project crews almost always react to what they see, so aircraft are not launched until clouds grow to treatable sizes, or at least appear headed that way. The bottom line is that the launch time doesn't change much regardless of what type aircraft is being used, and the project with slower aircraft ends up just missing many of the more distant opportunities.

Another argument is sometimes made in favor of using light single-engine aircraft. Smaller, less sophisticated aircraft can legally be flown by less experienced pilots, so there are therefore more pilots available to fly those aircraft. The other side of this dark coin (in addition to the slowed response), is that these less-experienced pilots still must fly in close proximity to the thunderstorms; always a non-trivial endeavor. The less experience a pilot has, the more likely he/she is to make a poor choice, and thunderstorms are very unforgiving. Matters are significantly further complicated when nocturnal missions are involved. The requirements for weather modification pilots are thus summarized as follows:

Weather Modification Pilot Requirements

- Multi-engine instrument rating. All weather modification pilots must be IFR-capable, regardless of whether they are assigned to a cloud top or cloud base seeding aircraft.
- Pilots should have as much actual IFR time (as opposed to hood IFR time) logged as possible.
- Working knowledge of thunderstorms, including structure, evolution, hazards, accessory clouds, and safety procedures. Most of the time this must be taught in the classroom, and also as first-hand experience while flying as a copilot trainee.
- Functional knowledge of weather modification principles, methods, and likely effects.
- Previous experience, either as a weather modification intern or in the right seat on a previous weather modification program. Ideally, a full season would be deHSIRed, but less is often accepted because there simply aren't enough seasoned pilots available. Weather modification techniques and safety can't be learned in just six weeks, nature has too many variations. If one asks a veteran weather modification pilot (10 years plus experience) when they reached the point they thought they knew everything they needed

to know, most will tell you that they are not to that point yet—at least the truly honest will.

- Of course, the pilot must be qualified for the type aircraft to be flown, and insured to fly said aircraft.

14.10.2 Meteorologist qualifications

Weather modification operations should be entrusted to persons possessing no less than a Bachelor's degree in atmospheric science or meteorology, or to persons having considerable field experience, preferably both. The degree reflects the completion of a college level four-year course of study, sufficiently broad that the individual has learned the basics of synoptic and mesoscale meteorology, radar, cloud physics, and forecasting. Also very helpful are courses in convective dynamics, atmospheric thermodynamics, instrumentation, and so on. Breadth of knowledge leads to better decision-making in complex and rapidly evolving weather situations. The meteorologists are responsible for suspension of operations, so considerable trust is accorded them. Each meteorologist's credentials must be worthy of such trust.

The State of Texas requires that those persons conducting weather modification operations meet certain minimum standards before they are allowed to do so. The qualifications of each individual seeking to control operations are reviewed, presently by the TNRCC, soon by the Department of Licensing and Permitting. Foremost among the Texas qualifications is the need for a four-year degree in meteorology or atmospheric science, or the equivalent.

It is recommended herein that those meteorologists given charge of operational weather modification projects be certified by the Weather Modification Association, or should seek such certification as soon thereafter as possible. The Association offers certification of weather modification operators, and as weather modification managers. Complete information about this certification program can be found on the Weather Modification Association web site at www.weathermodification.org.

14.10.3 Technicians

Technicians are essential to maintain radars, seeding equipment, and myriad project computers. Aircraft maintenance, both mechanical and electronic, is addressed in Table 94. In most cases, local fixed based operators (FBOs) can provide these services, though not always with the immediacy the project may require. Service of aircraft avionics is also included in the aircraft maintenance line item.

The technicians retained for the program do much of their seasonal work at and just prior to project start-up. These duties include the siting (when necessary), power-up, and calibration of the radars, and perhaps installation of TITAN software. A complete solar calibration of each radar must also be completed prior to project start; to ensure that dish alignment is correct as the season begins. This should be done at all sites, not just at new sites. Technicians are also often called upon to troubleshoot malfunctioning seeding equipment (flare racks, etc.) so they must be

well-versed in the equipment used, and must have the appropriate test equipment to diagnose problems.

Quality radar maintenance is essential. Preventive radar maintenance must be conducted on a regular basis. The WSR-74C weather radars are very reliable when properly installed, weatherized, and grounded, and failures are infrequent. However, when problems do occur, service must be same-day. Preventive maintenance can be scheduled on a rotating basis, wherein technicians are given responsibility for all radars within four adjacent APRs. With sixteen APRs, this means each technician will be responsible for four radars, and the seeding equipment of all the aircraft in those APRs.

Each technician will be engaged in continuous preventive maintenance, checking each radar for calibration, alignment, lubrication, automatic frequency control, ventilation/filtration, lighting, and auxiliary power every eight to ten days, continuously throughout the season. Experience has shown that preventive maintenance significantly reduces major down time, by identifying problems early, and correcting them. A good example is the brushes in the antenna pedestal—the TITAN systems turn the radars at 5 rpm, so worn brushes will quickly result in problems. Regular checks will identify radar pedestals that will soon need brush replacements, so that on the next visit (or the one thereafter) the technician can plan on taking the radar off-line during a slow morning and replacing the worn brushes. A program emphasizing preventive maintenance is best, but it also means that the technicians must all be very familiar with the WSR-74C radars.

For the program described herein, the electronics technicians shall be each assigned to four APRs, a larger area called a Maintenance Region (MR). These are defined as follows:

- Maintenance Region A – North Plains, Panhandle, High Plains, and Red River APRs.
- Maintenance Region B – Colorado River, West Central, North Central, and Central APRs.
- Maintenance Region C – Far West, South Pecos, West, and Texas Border APRs.
- Maintenance Region D – Edwards, Southwest, South, and Far South APRs.

In the event problems overwhelm a technician in one MR, technicians from other MRs can assist as availability allows. Thus, assignment to a specific MR does not preclude a technician from working in others.

The single largest uncertainty regarding maintenance is replacement parts for the aging radars. While the radars are still dependable, most are decades old, and periodic failures of major components will be common, especially when operating sixteen sets! The radar maintenance budget thus anticipates major failures of this nature, so as not to be caught short when the inevitable occurs.

14.10.3 Training

This program, should it come about, will instantly create a great demand for weather modification pilots, meteorologists, and technicians, far exceeding the industry's present capacity. Therefore, an extensive training program will have to be undertaken for sponsors, and for the new project personnel.

The American Society of Civil Engineers is presently developing standards for various weather modification operations, and as part of this effort will begin conducting multi-day workshops on specific topics, the first to occur in November 2001. It would behoove this program's sponsor(s) to work with ASCE to establish and conduct such training workshops as needed within the State of Texas.

Classroom training is not a replacement for field experience, neither at the radar console, nor in the cockpit. Obtaining this experience will be a more daunting task; some inexperienced but otherwise qualified personnel will likely have to be retained and trained on the job.

14.11 DEPLOYMENT OF AIRCRAFT

The area proposed for weather modification operations in this report includes approximately 199,800 square miles, or about 128 million acres. Together, this is an immense area, the largest single target area ever proposed for weather modification operations of this type.

Historically, weather modification target areas have been much more often of the sizes of the individual APRs. Therefore, this project design is based upon the needs of the typical-sized regions (for which the industry has much experience), and extrapolates this forward, realizing a certain economy of scale.

In determining the number and locations of the aircraft to be deployed, the following factors were considered:

- The size of the APR in which the aircraft will be based.
- Whether or not that APR is located on the upwind (generally west) side of the total operations area. These areas must respond to begin treatment of (presently) untreated systems as they enter the state, primarily from New Mexico. This will require additional resources.
- The number of adjacent APRs from which resources might be readily available. In other words, treatable clouds are not expected to develop simultaneously over all APRs. Instead, convective weather is almost always focused on areas near frontal systems, low-pressure centers, local convergence boundaries, etc. As a result, the weather systems generally translate from one APR to the next, so some resources (primarily aircraft) can be readily shared.

- The expected daily flight time of the pilots. Though aircraft can be readily shared from one APR to another, the pilots cannot fly indefinitely each day. Flying convective storms is mentally and physically demanding work, even in the best conditions. Therefore, the flight crews are not expected to work beyond their own APR and the adjacent APRs. In other words, a pilot launched from San Angelo (West APR) will not be expected to stay with the weather system beyond the Edwards APR as it moves southeast; aircraft from the Edwards and South APR would be expected to do that.
- The type of aircraft proposed, and their cruise speeds. Higher performance aircraft can cover more airspace and treat more clouds than lesser aircraft. The aircraft proposed herein are mid-range (see again, Figure 29).
- The proximity at which cloud top aircraft can operate. Cloud top seeding aircraft operate in IMC, in controlled airspace, within block altitudes (a layer of three or four thousand feet in thickness), and usually within an area established by verbal, real-time agreement with the responsible air traffic controller. It is thus neither allowed, nor safe, to fly multiple aircraft in close proximity, so the number of cloud top aircraft assigned to each APR is limited accordingly, even though they are more efficient.

Examination of other successful rainfall enhancement programs reveals that the number of aircraft deployed is a balance between what is needed to do the job in the “worst case” scenario, and what can be afforded. In other words, if a target area sometimes has enough clouds to keep eight aircraft busy, but usually only half that many, that project will typically deploy the lower number, or perhaps even slightly less, depending upon budget considerations.

Because all APRs will be in regular contact with each other, the aircraft resources can be effectively shared with adjacent APRs, reducing the need for any one APR to have as many aircraft as they might have operating as an independent entity. For example, the long-established North Dakota Cloud Modification Program, in operation since 1961 (Boe et al., 1999), has two APRs totaling 10,441 square miles (6.7 million acres). That project annually deploys two cloud top aircraft, and six cloud base aircraft. The program’s two APRs are not adjacent, and aircraft sharing is rarely attempted.

If like coverage was to be accomplished in the proposed Texas target area without aircraft sharing, about 150 aircraft would be required! However, with aircraft sharing, similar coverages are achieved with only 41 aircraft. Table 93 lists the aircraft based in each APR, but also those available to that APR from adjacent APRs. From this table, it is seen that total aircraft coverage per APR approaches that of the North Dakota program, when shared aircraft are considered.

A significant factor not fully known in this proposed aircraft allocation is the cumulative effect of aircraft sharing upon pilot endurance. Having responsibility spread over many adjacent APRs will most certainly increase hours flown in all phases of the project, that is, for actual seeding, reconnaissance, and ferry to/from the base of operations. This aspect of the program should be carefully monitored, for there is some possibility that during especially active periods some flight crews could be overworked.

14.12 INSURANCE

There are at least three types of aviation insurance that must be established prior to the onset of weather modification operations. One is the aircraft hull insurance covering the aircraft deployed on the project. The second is property coverage needed to cover the radars and equipment used on the project. The third is aircraft liability insurance for the operation of an aircraft.

Standard aircraft liability policies typically will not cover any claims brought as a result of a consequential loss, that is, any result of the cloud seeding operations. It is imperative to negotiate back into the policy coverage for consequential losses. The latter may not pay claims arising from weather modification complaints, but is intended to provide for the defense costs, should such claims be brought. Many persons do not realize that commercial general liability policies do not cover the operations of weather modification. It is important to inform the insurance agent of the details of the program so he can assist in obtaining the most comprehensive coverage necessary to cover the intended operations

14.13 PROJECTED COSTS

Projected program costs are set forth in Table 94.

Table 94. Cost Estimates for an Eight Month Operational Period (March 1 – October 31)				
<i>Section 1: RADAR – Enterprise WSR-74C</i>				
	Number of Radars	Unit Cost	Total Cost	Comment
Purchase Price, with TITAN and RDAS:	6	\$175,000	\$1,050,000	10 radars already deployed
Deployment Cost:	6	\$40,000	\$240,000	10 radars already deployed
Maintenance, & Parts:	16	\$10,000	\$160,000	Anticipates major component replacements, routine maintenance
Utilities and Supplies (per mo.):	16	\$2,000	\$32,000	Electricity, gas for auxiliary power unit
Insurance:	16	\$900	\$14,400	
Technician:	4	\$44,000	\$176,000	Each technician will be assigned four radars
Aircraft Data Telemetry Downlinks:	6	\$9,600	\$57,600	10 radars already equipped
<i>TOTAL INITIAL SEASONAL COST:</i>			\$1,730,000	

<i>TOTAL COSTS, SUBSEQUENT SEASONS:</i>			\$459,200	\$4,800 per site allocated for upkeep and upgrades to systems, including computers
---	--	--	-----------	--

Section 2: CLOUD BASE AIRCRAFT – Piper Seneca II

	Number of Aircraft	Unit Cost	Total Cost	Comment
Purchase Price:	21	\$144,000	\$3,024,000	1979, average airframe, engines
Initial Deployment Cost:	21	\$12,900	\$270,900	Installation of seeding equipment, aircraft telemetry equipment
Fuel, Oil, Maintenance, and Hull Insurance:	21	\$35,000	\$735,000	Assumes 200 flight hours per aircraft
Aircraft Data and Telemetry System:	21	\$12,000	\$252,000	
Seeding Equipment:	21	\$24,500	\$514,500	Wing racks and wing-tip generators
Pilot:	21	\$40,000	\$840,000	\$2,500/mo. Salary +\$2,500/mo. Per diem
<i>TOTAL INITIAL SEASONAL COST:</i>			\$5,636,400	
<i>TOTAL COSTS, SUBSEQUENT SEASONS:</i>			\$2,100,000	Includes \$25K per aircraft per year, maintenance

Section 3: CLOUD TOP AIRCRAFT – Cessna 340 Ram

	Number of Aircraft	Unit Cost	Total Cost	Comment
Purchase Price:	20	\$280,000	\$5,600,000	1979, average airframe, engines
Initial Deployment Cost:	20	\$12,900	\$258,000	Installation of seeding equipment, aircraft telemetry equipment
Fuel, Oil, Maintenance, and Hull Insurance:	20	\$44,000	\$880,000	Assumes 200 flight hours per aircraft
Aircraft Data and Telemetry System:	20	\$12,000	\$252,000	
Seeding Equipment:	20	\$25,000	\$500,000	Wing racks and wing-tip generators
Pilot:	20	\$44,000	\$880,000	\$3,000/mo. Salary +\$2,500/mo. Per diem
<i>TOTAL INITIAL SEASONAL COST:</i>			\$8,370,400	

<i>TOTAL COSTS, SUBSEQUENT SEASONS:</i>			\$2,360,000	Includes \$30K per aircraft per year, maintenance
Section 4: SEEDING AGENTS				
	Units	Unit Cost	Total Cost	Comment
150 gram Burn-In-Place (BIP) Flares:	2,100	\$72.00	\$151,200	
40 gram Burn-In-Place Flares:	12,600	\$32.50	\$409,500	
20 gram Ejectable Flares:	30,000	\$20.50	\$615,000	
Acetone-based Seeding Solution (gal):	6,000	\$30.00	\$180,000	
1 Kg. Hygroscopic Flares:	500	\$150.00	\$75,000	Trial basis only during first season
<i>TOTAL SEASONAL COST:</i>			\$1,430,700	
Section 5: METEOROLOGICAL SUPPORT SERVICES				
	Units	Unit Cost	Total Cost	Comments
Radar Meteorologists:	32	\$40,000	\$1,280,000	Two per site, per 8-mo. Project
Pentium II Class Computers for Internet Access (forecasting):	16	\$1,000	\$16,000	One-time cost only, at least until units require replacement
Internet Access:	16	\$160	\$2,600	Per site, per 8-mo. Season
Office Supplies, Data Recording Media:	16	\$1,000	\$16,000	
<i>TOTAL SEASONAL COST:</i>			\$1,314,600	
Section 6: TOTAL PROJECTED COSTS, FIRST SEASON				
	Total Cost	Comments		
Radars and Data Acquisition:	\$1,730,000	Six radars purchased, sited, and equipped; all 16 radars operated.		
Cloud Base Seeding Aircraft:	\$5,636,400	Assumes all aircraft must be purchased; this is certainly not the case, as at least some of the aircraft presently deployed are suitable.		
Cloud Top Seeding Aircraft:	\$8,730,400	Assumes all aircraft must be purchased; this is certainly not the case, as at least some of the aircraft presently deployed are suitable. Cessna 340's are presently used by many projects.		
Seeding Agents:	\$1,430,700			
Meteorological Support:	\$1,314,600	One senior, one junior (intern) meteorologist per site. This budget does not include any analysis or data quality control efforts.		

<i>TOTAL INITIAL SEASONAL COST:</i>	\$18,842,100	This most certainly is an over-estimate, as perhaps a dozen or more aircraft presently deployed will meet the standards set forth here outright. The present numbers, aircraft types, and mechanical condition have not been tabulated.
<i>TOTAL COSTS, SUBSEQUENT SEASON:</i>	\$7,548,765	Estimated operations costs, assuming 5% inflation. Insurance for the effects of weather modification are not included in this budget.

The cost estimates given in Table 94 are *only estimates*, subject to fluctuations in the aviation market, the price of avgas, and numerous other variables. Prices shown here reflect best estimates provided by Weather Modification, Inc., as of 1 August 2001, and do not constitute bids.

Ten radars are already deployed and equipped with TITAN and aircraft tracking, therefore the cost of acquiring these items is not added to the proposed program. However, their maintenance is included.

There are dozens of aircraft presently deployed in Texas programs, ranging from light single engine aircraft up to Cessna 340s. Though many of these aircraft can likely be applied directly to the proposed program, their existence is not included in the project cost estimates, for their number, type, and condition is not known. Hence, the aircraft acquisition costs shown in Table 94, Sections 2 and 3, could undoubtedly be adjusted significantly downward. This is not done already because the minimum aircraft specifications recommended herein exceed those of some aircraft presently deployed, and ultimately it will be up to the Texas Water Development Board or sponsoring agency to make the determination as to aircraft type(s) utilized.

No costs are included for data collection (other than the burning of monthly CDs for archival purposes) quality control, or analysis. The question of just how to analyze such an expansive program must be addressed separately.

15.0 CONCLUSIONS AND RECOMMENDATIONS

15.1 Major Study Assumptions and Uncertainties

This investigation is a broad, conceptual examination of the potential impacts of hypothetical seeding induced rainfall (HSIR) on the hydrogeology of Texas. Because of the many assumptions and uncertainties inherent to the study, its results must be view qualitatively rather than quantitatively. Most critical is the assumption that glaciogenic cloud seeding enhances rainfall on an area basis. Although the collective evidence suggests that cloud seeding increases rainfall from individual clouds and cloud clusters, proof of its efficacy on an area basis does not exist (Task 1). Much of this research is based on the results of a randomized cloud seeding experiment over floating targets in Thailand. Although the apparent seeding effects are large, ranging as high as +91%, they are not statistically significant and they are confounded by

the natural rainfall variability. A more realistic, but still uncertain, estimate of the effect of seeding, based on linear regression, is +43% for floating targets of about 2,000 km². In addition, the climate and terrain differences between Thailand and Texas raise additional questions about the transferability of the Thai results to Texas. Further, the apparent seeding effects in Thailand and elsewhere must be extrapolated to hydrogeologic areas of various size, typically larger much larger than the targets of past experimentation, in order to meet the goals of this study. In one scenario, these extrapolations are made as a function of satellite inferred cloud microphysical structure (Task 2); again based on past research results in Thailand. Because of these uncertainties, a range is assigned (i.e., low, middle and high) to the hypothetical seeding effects to be superimposed on the radar-estimated rainfalls as a function of area size (Task 3). Comparisons between gauges and radar suggest that the radar-estimated rainfalls are accurate to within $\pm 20\%$ on a monthly basis.

In view of the many uncertainties associated with this study, many of which are beyond reliable quantification, it is emphasized that the HSIR values generated are meant to be illustrative of likely potential general impacts on surface and groundwater resources, consistent with hydrogeologic principles and the hydrogeologic settings of the study areas. The values should not be considered definitive or precise and have not been subjected to an intense statistical analysis since such results would suggest a greater certainty in the values than in fact exists. The data produced by this study are meant to guide future research to areas where HSIR would likely be most productive.

15.2 Study Accomplishments

The assessment of weather modification as a water management strategy for Texas has been completed successfully with the achievement of all objectives. It began by laying the scientific foundations for cloud seeding efforts and ended by providing costs estimates for a massive cloud seeding effort over the portions of Texas thought to be most suitable for cloud seeding intervention. Much has been learned along the way. Although it appears that cloud seeding increases rainfall under some circumstances, it is not yet a proven technology when applied on an area basis. As discussed in the Report, the reasons for this are many and varied. In the case of the randomized seeding experimentation in Texas, the funding agency stayed with the program for only 2 of its scheduled 5 full seasons, despite the positive results that had been obtained up to the time of project termination. In retrospect premature termination of this program was a serious blunder whose effects are still being felt today.

The positive but limited evidence for the efficacy of cloud seeding to enhance rainfall has been used to justify the existing operational cloud seeding programs in Texas. This evidence also has provided the basis for this assessment of the potential of cloud seeding as a water management strategy for Texas. It involved the radar estimation of rainfall over the entire state and 50 subareas of interest (seeding targets, drainage basins and aquifers) for the 1999 and 2000 seasons (April through September). Hypothetical seeding effects were superimposed on these radar-estimated rainfalls for the 10 existing Texas seeding targets as a function of the satellite derived cloud structure, where the relationship between cloud structure and seeding effect was obtained from cloud seeding research by the first author in Thailand. Although the approach for the 40 hydrologic areas was somewhat different, the end result is about the same in suggesting that cloud seeding could be highly beneficial for some areas in Texas. Increases in seasonal

rainfall of about 10% are indicated for the largest areas (i.e., $> 50,000 \text{ km}^2$), and nearly a doubling of the rainfall may be possible for the smallest areas (i.e., $< 1,000 \text{ km}^2$) under consideration.

One of many assumptions in this study is that the seeding nucleant can and will be delivered by experienced pilots to all of the target clouds at the time and place that it will be most effective. Even with the use of aircraft, this assumption is probably not valid on many occasions in the real world in which some program managers "cut corners" to fit their effort into their budget. Although this is understandable, it is unwise. Thus, the estimates of hypothetical seeding effect are likely too high in view of current seeding practice, which often falls well short of the ideal. This is an area in which improvement is needed.

The availability of merged NEXRAD radar reflectivity data from which rainfall was derived was a major plus for this study. It was the only way monthly and seasonal rainfall estimates to accuracies of 10% to 20% could have been obtained for the 50 areas of interest. Had this resource not existed, we would have had great difficulty in reaching the objectives of this investigation. More study is needed to determine radar-rainfall accuracies on a daily basis.

The hydrogeologic component of this investigation made good use of the available data in assessing the impact of possible seeding-induced increases of precipitation on the water supply of Texas. Certainly nothing of this magnitude has ever been done before in the context of cloud seeding experiments. In view of the many acknowledged uncertainties only general guidelines were possible. It did, however, set the stage for further more focused research on a few hydrogeologic areas along the lines of those presented for the Edwards Aquifer rather than the "broad-brush" approach required for this study.

The design and cost estimates for a cloud seeding program over the portions of Texas that would likely benefit from such a program make it obvious that cloud seeding is a complex and expensive business. Startup costs approaching \$19 million are envisioned with recurring annual costs of about \$7.5 million. The area in question is over twice the size of the combined current 10 seeding targets (i.e., 128 million acres vs. 56 million acres), and it is highly doubtful whether a doubling of the effort would be justified in view of the many current uncertainties and operational deficiencies. We simply do not know enough presently to warrant such a massive effort. Some have offered the same view with respect to the current operational seeding programs.

A major recommendation emanating from this study is that the current operational cloud seeding programs be evaluated for operational efficiency and enhanced rainfall before further augmenting the operational program. All readily understand the importance of evaluation of the seeding efforts. The Texas Weather Modification Association has mounted its evaluation effort, and the first author of this report and his colleague Dr. Daniel Rosenfeld have devised and are applying their own analysis approach to 2 of the 10 existing operational cloud seeding efforts. In principle, their approach can be extended to the entire program, provided a careful record of aircraft flight tracks and seeding actions is available. At this writing the "jury is still out" on all attempts to evaluate the operational cloud seeding programs.

A second recommendation is that Texas finish what it started with respect to its randomized cloud seeding effort. Only 38 experimental units were obtained in the truncated program, and this not enough by any measure to demonstrate an effect of seeding on an area basis. Instead, many of the key results that served as input to this study were obtained in a randomized experiment by the first author and his colleague in Thailand. Even then, the Thai experiment ended on schedule with highly positive but inconclusive results. Further, some will question the applicability of results obtained in Thailand to Texas because of differences in target terrain and climatology.

Any new experimentation must have a strong physical component in which key measurements are made to understand how and why cloud seeding affects clouds that produce increased rainfall and those that do not. Furthermore, the efficacy of hygroscopic seeding (sprays and flares) should be tested in Texas. Positive results obtained in South Africa, Thailand and Mexico clearly warrant it.

Focused studies of the potential effect of cloud seeding on specific drainages and aquifers in Texas are also needed, and the Edwards Aquifer would be a great place to start. The current study made a nice start in this area, but it represents only a small beginning for what is a highly complex and intriguing investigation. Hydrologic computer models exist for most surface drainage basins and are being developed for various aquifers. These should be applied to more accurately test hypothetical seeding scenarios. The results should be integrated into cost-benefit analyses to determine which areas will likely receive the greatest benefit from seeding with the limited funds available.

In the final analysis our recommendation is that political and scientific leadership in Texas work together to map out an all-inclusive program to investigate the potential of cloud seeding for enhancing the water resources of the state. The tools and expertise exist; they just need to be put to work. Further, the effort should be a partnership between scientific and operational interests with each sector providing needed input. The costs will be commensurate with the effort involved and certainly larger than what has been attempted heretofore in Texas.

16.0 ACKNOWLEDGMENTS

The TWDB (Texas Water Development Board) supported the work described in this Final Report under Contract No. 2000-481-343 with Woodley Weather Consultants. The advice and assistance provided by Mr. Matt Nelson of the TWDB in this endeavor is gratefully acknowledged.

The section of the report dealing with the estimation of the impacts of increased seeding-induced rainfall on Texas surface water and groundwater represents the work of Dr. George Veni, hydrogeologist, of George Veni and Associates. It was written in consultation with the senior author Dr. William Woodley of Woodley Weather Consultants. Data, advice, and other general assistance were also provided by Michael Albach of Bexar Metropolitan Water District, Bobby Bader, Roberto Esquilin, Jesse Mireles, and Geary Schindel of the Edwards Aquifer Authority, and John Waugh of the San Antonio Water System.

17.0 REFERENCES

- AMS, 1998a: Policy Statement: Planned and Inadvertent Weather Modification. *Bull. Amer. Meteor. Soc.*, **79**, 2771-2772.
- AMS, 1998b: Scientific Background for the AMS Policy Statement on Planned and Inadvertent Weather Modification. *Bull. Amer. Meteor. Soc.*, **79**, 2773-2778.
- ASCE, 2000: Standard Practice for the Design and Operation of Precipitation Enhancement Projects. A draft document for consideration by the ASCE Atmospheric Water Management Standards Committee, Guidelines for Cloud Seeding Operations. Prepared by the Precipitation Enhancement Subcommittee. Last revised on 28 March 2000 in accordance with draft CSAC guidelines.
- Ashworth, John B. 1983. Ground-water availability of the lower Cretaceous formations in the Hill Country of south-central Texas. Report 273, Texas Department of Water Resources, 172 pp.
- Ashworth, John B. 1990. Water resources in the El Paso area. In *Hydrogeology of Trans-Pecos Texas*, Charles W. Kreitler and John M. Sharp, Jr., eds., Guidebook 25, Bureau of Economic Geology, The University of Texas at Austin, pp. 21-25.
- Baker, Bernard, Gail Duffin, Robert Flores, and Tad Lynch. 1990. Evaluation of water resources in part of central Texas. Report 319, Texas Water Development Board, 67 pp.
- Baker, E.T. 1979. Stratigraphic and hydrogeologic framework of a part of the Coastal Plain of Texas. Report 236, Texas Department of Water Resources, 43 pp.
- Baker, E.T. 1986. Hydrology of the Jasper Aquifer in the southeast Texas coastal plain. Report 295, Texas Water Development Board, Austin, 64 pp.
- Baker, E.T., Jr., R.M. Slade, Jr., M.E. Dorsey, L.M. Ruiz, and Gail L. Duffin. 1986. Geohydrology of the Edwards Aquifer in the Austin area. Report 293, Texas Water Development Board, Austin, 217 pp.
- Barker, René A., and Ann F. Ardis. 1996. Hydrogeologic framework of the Edwards-Trinity Aquifer System, west-central Texas. Professional Paper 1421-B, U.S. Geological Survey, 61 pp. + 8 pls.
- Barnes, J.R. 1956. Available ground water from Carrizo Sand in Wilson County, Texas. Report to the Guadalupe-Blanco River Authority, 13 pp.
- Barrett, Michael E., and Randall J. Charbeneau. 1996. A parsimonious model for simulation of flow and transport in a karst aquifer. Technical Report 269, Center for Research in Water Resources, The University of Texas, Austin, 149 pp.

- Battan, L. J. and A. R. Kassander, 1960: Design of a program of randomized seeding of orographic cumuli. *J. Meteor.*, **17**, 583-590.
- Battan, L.J., 1966: Silver-iodide seeding and rainfall from convective clouds. *J. Appl. Meteor.*, **5**, 669-683.
- Bentacourt, 1966: *J. Appl. Meteor.*, **2**, 311-323.
- Bergeron, T., 1935: On the physics of clouds and precipitation. Procl 5th Assembly IUGG, Lisbon, 156-178.
- Bigg, E. K., 1997: An independent evaluation of a South African hygroscopic cloud seeding experiment, 1991-1995. *Atmos. Res.*, **43**, 111-127.
- Bluntzer, Robert L. 1992. Evaluation of the ground-water resources of the Paleozoic and Cretaceous aquifers in the Hill Country of central Texas. Report 339, Texas Water Development Board, 181 pp.
- Boe, B.A., and P.J. DeMott, 1999: Comparisons of Lohse Wing-tip nuclei generators and burn-in-place pyrotechnics in the North Dakota Cloud Modification Project. *J. Weather Modif.*, **31**, 109-117.
- Boe, B.A., D.W. Langerud, and P.T. Moen, 1999: North Dakota Cloud Modification Project Operations Manual. North Dakota Atmospheric Resource Board, Bismarck, ND, 57 pp.
- Bomar, G.W., W.L. Woodley, D. Rosenfeld and R. Jones, 1995: Design and Implementation and Operational Summary of TEXARC 1994. Report by the Texas Natural Resources Conservation.
- Bomar, G.W., 1995: *Texas Weather*, second edition. University of Texas Press, Austin, Texas. 275 pp.
- Bomar, G.W., W.L. Woodley and D.L. Bates, 1999: The Texas weather modification program: Objectives, approach and progress. *J. Wea. Mod.*, **31**, 9-22.
- Bowen, E. G., 1966: The effect of persistence in cloud seeding experiments. *J. Appl Meteor.*, **5**, 156-159.
- Braham, R.R., Jr., 1966: Final report of Project Whitetop, Part I, II. Dept. of Geophysical Sciences, University of Chigago, 156pp.
- Braham, R.R., Jr., 1986: Precipitation enhancement – A scientific challenge. *Precipitation Enhancement-A Scientific Challenge, Meteor. Monogr.* No. 43, Amer. Meteor. Soc., 1-5.
- Brown, D.S., B.L. Petri, and G.M. Nalley. 1992. Compilation of hydrologic data for the Edwards Aquifer, San Antonio area, Texas, 1991, and 1934-91 summary. Bulletin 51, Edwards Underground Water District, 169 pp. + 6 pls.

- Bruintjes, R. T., T. L. Clark, and W. D. Hall, 1994: Interactions between topographic airflow and cloud/precipitation development during the passage of a winter storm in Arizona. *J. Atmos. Sci.*, **51**, 48-67.
- Bruintjes, R.T., D.W. Breed, M.J. Dixon, B.G. Brown, V. Salazar, and H.R. Rodriguez, 1999: Program for the augmentation of rainfall in Coahuila (PARC): Overview and preliminary results. *Preprints 14th Conf. On Planned and Inadvertent Weather Modification, Everett, WA*, 600-603.
- Bruintjes, R.T., 1999: A review of cloud seeding experiments to enhance precipitation and some new prospects. *Bull. Amer. Meteor. Soc.*, **80**, 805-820.
- Bruintjes, R. T., D. Griffith, J. Golden, H. D. Orville, M. Politovich and M. Roos, 2000: Standard practice for the design and operation of precipitation enhancement projects. Draft manuscript for the ASCE Manual of Professional Practice Version 99.2, Amer. Soc. Of Civil Engineers, New York City, NY, 69-85.
- Bruintjes, R.T., D.W. Breed, V. Salazar, M. Dixon, T. Kane, G.B. Foote, and B. Brown, 2001: Overview and results from the Mexican hygroscopic seeding experiment. *Preprints, AMS Symposium on Planned and Inadvertent Weather Modification, Albuquerque, NM*.
- Buckner, H.D., E.R. Carrillo, and H.J. Davidson. 1985. Water resources data, Texas, water year 1984. Water-Data Report TX-84-3, U.S. Geological Survey, 429 pp.
- Buckner, H.D., E.R. Carrillo, and H.J. Davidson. 1986. Water resources data, Texas, water year 1985. Water-Data Report TX-85-3, U.S. Geological Survey, 447 pp.
- Buckner, H.D., E.R. Carrillo, and H.J. Davidson. 1987. Water resources data, Texas, water year 1986. Water-Data Report TX-86-3, U.S. Geological Survey, 405 pp.
- Buckner, H.D., E.R. Carrillo, and H.J. Davidson. 1988. Water resources data, Texas, water year 1987. Water-Data Report TX-87-3, U.S. Geological Survey, 417 pp.
- Buckner, H.D., and W.J. Shelby. 1990. Water resources data, Texas, water year 1990. Water-Data Report TX-90-3, U.S. Geological Survey, 443 pp.
- Buckner, H.D., and W.J. Shelby. 1991. Water resources data, Texas, water year 1991. Water-Data Report TX-91-3, U.S. Geological Survey, 451 pp.
- Carr, J.E., W.R. Meyer, W.M. Sandeen, and I.R. McLane. 1985. Digital models for simulations of ground-water hydrology of the Chicot and Evangeline aquifers of the Gulf Coast of Texas. Report 289, Texas Water Development Board, Austin, 110 pp.
- Cooper, W. A. and C. P. R. Saunders, 1980: Winter storms over the San Juan Mountains. Part II: Microphysical processes. *J. Appl. Meteor.*, **19**, 927-941.

- Cooper, W.A. and J. D. Marwitz, 1980: Winter storms over the San Juan Mountains. Part III: Seeding potential. *J. Appl. Meteor.*, **19**, 942-949.
- Cooper, W.A., R.P. Lawson, T.A. Cerni, and A.R. Rodi, 1982: Cloud physics investigations by the University of Wyoming in Hiplax 1980. Rep. To the U. S. Bureau of Reclamation, University of Wyoming, Laramie, WY, 256pp.
- Cooper, W. A., R. T. Brintjes, and G. K. Mather, 1997: Calculations pertaining to hygroscopic seeding with flares. *J. Appl. Meteor.*, **36**, 1449-1469.
- Cotton, W.R., 1986: Testing, implementation and evolution of seeding concepts-A review *Precipitation Enhancement-A Scientific Challenge, Meteor. Monogr.* No. 43, Amer. Meteor. Soc., 139-149.
- Cunning, J.B., Jr., 1976: Comparison of the Z-R relationship for seeded and non-seeded Florida cumuli. *J. Appl. Meteor.*, **15**, 1121-1125.
- Dennis, A. S., A. Koscielski, D. E. Cain, J. H. Hirsch, and P. L. Smith, Jr., 1975: Analysis of radar observations of a randomized cloud seeding experiment. *J. Appl. Meteor.*, **14**, 897-908.
- Dennis, A.S., 1980: *Weather Modification by Cloud Seeding*. Academic Press, New York. 267 pp.
- DeMott, P.J., 1997: Report to the North Dakota Atmospheric Resource Board and Weather Modification, Inc., on Tests of the Ice Nucleating Ability of Aerosols Produced by the Lohse Airborne Generator – 1997. Colorado State University Cloud Simulation and Aerosol Laboratory, Fort Collins, CO. 14 pp, appendices.
- Dixon, M., and G. Weiner, 1993: TITAN: Thunderstorm Identification, Tracking, Analysis, and Nowcasting-- A radar-based methodology. *J. Atmos. Ocean. Tech.*, **10**, 785- 797.
- Dutton, Alan R. 1999. Groundwater availability in the Carrizo-Wilcox Aquifer in central Texas – numerical simulations of 2000 through 2050 withdrawal projections. Report of Investigations No. 256, Bureau of Economic Geology, The University of Texas at Austin, 53 pp.
- Edwards Underground Water District. 1992 (not dated). Edwards Underground Water District. Edwards Underground Water District, San Antonio, Texas, 16 pp.
- Elliott, R. D., 1986: Review of wintertime orographic cloud seeding, *Precipitation Enhancement - A Scientific Challenge*. R. R. Braham, Jr., Ed., *Meteor. Monogr.*, No 43, Amer. Meteor. Soc., 87-103.
- Esquilin, Roberto. 2000. Edwards Aquifer Authority hydrologic data report for 1999. Report 00-02, Edwards Aquifer Authority, 89 pp.

- Findeisen, W., 1938: Die kolloidmeteorologischen vorgänge bei der Niederschlagsbildung. *Meteor. A.*, **55**, 121-131.
- Flueck, J.A., W.L. Woodley, A.G. Barnston, and T.J. Brown, 1986: A further assessment of treatment effects in the Florida Area Cumulus Experiment through guided linear modeling. *J. Appl. Meteor.*, **25**, 546-564.
- Fisher, W.L. 1990. Technical factors in Edwards Aquifer use and management. In *Special Committee on the Edwards Aquifer*, Cyndi T. Krier and Terral Smith, eds., Committee Report to the 72nd Texas Legislature.
- Fogg, Graham E. 1989. Stochastic analysis of aquifer interconnected: Wilcox Group, Trawick area, east Texas. Report of Investigations No. 189, Bureau of Economic Geology, The University of Texas at Austin, 68 pp.
- Fogg, Graham E., and Charles W. Kreitler. 1982. Ground-water hydraulics and hydrochemical facies in Eocene aquifers of the East Texas Basin. Report of Investigations No. 127, Bureau of Economic Geology, The University of Texas at Austin, 75 pp.
- Gabriel, K.R. and D. Rosenfeld, 1990: The second Israeli rainfall stimulation experiment. Analysis of precipitation on both targets. *J. Appl. Meteor.*, **29**, 1055-1067.
- Gabriel, K.R., 1999a: Planning and evaluation of weather modification projects. *Proceedings of the Seventh WMO Sci. Conf. on Wea Mod.*, Chiang Mai, Thailand, 17-22 February 1999, Volume III. Supplement, 39-59.
- Gabriel, K.R., 1999b: Ratio statistics for randomized experiments in precipitation stimulation. *J. Appl. Meteor.*, **38**, 290-301.
- Gabrysch, R.K. 1977. Development of groundwater in the Houston District, Texas, 1970-74. Open-File Report 77-413, U.S. Geological Survey, 44 pp.
- Gabrysch, R.K. 1984. Case No. 9.12, The Houston-Galveston region, Texas, USA. In *Guidebook to Studies of Land Subsidence Due to Ground-Water Withdrawal*, Joseph F. Poland, ed., UNESCO, pp. 253-262.
- Gagin, A. and J. Neumann, 1974: Rain stimulation and cloud physics in Israel. *and Climate Modification*. W. N. Hess, Ed., Wiley-Interscience, 454-494.
- Gagin, A. and J. Neumann, 1981: The second Israeli randomized cloud seeding experiment: Evaluation of results. *J. Appl. Meteor.*, **20**, 1301-1311.
- Gagin, A., 1981: The Israeli rain enhancement experiments. A physical overview. *J. Wea. Mod.*, **13**, 1-13.

- Gagin, A., D. Rosenfeld, and R.E. Lopez, 1985: The relationship between height and precipitation characteristics of summertime convective cells in South Florida. *J. Atmos. Sci.*, **42**, 84-94.
- Gagin, A., D. Rosenfeld, W. L. Woodley, and R. E. Lopez, 1986: Results of seeding for dynamic effects on rain-cell properties in FACE-2. *J. of Climate and Appl. Meteor.*, **25**, 1-11.
- Gagin, A., 1986: Evaluation of "static" and "dynamic" seeding concepts through analyses of Israeli II experiment and FACE-2 experiments. *Rainfall Enhancement - A Scientific Challenge, Meteor. Monogr.*, No. 43, Amer. Meteor. Soc., 63-70.
- Gandara, S.C., W.J. Gibbons, D.L. Barbie, and R.E. Jones. 2000. Water resources data, Texas, water year 1999. Water-Data Report TX-99, U.S. Geological Survey, 6 vols.
- Gandara, S.C., W.J. Gibbons, and D.L. Barbie. 2001. Water resources data, Texas, water year 2000. Water-Data Report TX-00, U.S. Geological Survey, 6 vols.
- Gandara, S.C., E.M. McPherson, W. Gibbons, B.A. Hinds, and F.L. Andrews. 1994. Water resources data, Texas, water year 1993. Water-Data Report TX-94-3, U.S. Geological Survey, 501 pp.
- Getzendaner, F.M. 1953. Supplement to replenishing Carrizo Sand water. Consulting report, files of the Texas Water Development Board, 13 pp.
- Grant, L. O., H. D. Orville, M. Politovich, R.F. Reinking, D. Rogers and J. Warburton, 1995: Section 4, The Scientific basis, ASCE Manual of Professional Practice No. 81, Amer. Soc. Of Civil Engineers, New York City, NY, 69-85.
- Groschen, George E. 1996. Hydrogeologic factors that affect the flowpath of water in selected zones of the Edwards Aquifer, San Antonio region, Texas. Water-Resource Investigation 96-4046, U.S. Geological Survey, 73 pp. + 3 pls.
- Ground Water Protection Unit. 1989. Ground-water quality of Texas - an overview of natural and man-affected conditions. Texas Water Commission, Report 89-01, 197 p. + 3 plates.
- Gustavson, Thomas C. 1990. Regional stratigraphy and geomorphic evolution of the southern Hueco Bolson, west Texas, and Chihuahua, Mexico. In *Hydrogeology of Trans-Pecos Texas*, Charles W. Kreitler and John M. Sharp, Jr., eds., Guidebook 25, Bureau of Economic Geology, The University of Texas at Austin, pp. 27-35.
- Hamblin, H. Scott. 1988. Deposition and ground-water flow systems of the Carrizo-Upper Wilcox, Texas. Report of Investigations No. 175, Bureau of Economic Geology, The University of Texas at Austin, 61 pp.
- Harringer, Ted L. 1985. Development of the Northern Segment of the Edwards Aquifer as a major water supply. In *Edwards Aquifer - Northern Segment, Travis, Williamson, and Bell counties*,

Texas, C.M. Woodruff, Jr., Fred Snyder, Laura De La Garza, and Raymond M. Slade, Jr., eds., Guidebook 8, Austin Geological Society, pp. 25-37.

Hauwert, Nico M., David A. Johns, and Thomas J. Aley. 1998. Preliminary Report on Groundwater Tracing Studies Within the Barton and Williamson Creek Watersheds, Barton Springs/Edwards Aquifer. Barton Springs/Edwards Aquifer Conservation District and City of Austin, 57 pp.

Henry, Christopher D., William E. Galloway, Gary E. Smith, Clara L. Ho, John P. Morton, and James K. Gluck. 1982. Geochemistry of ground water in the Miocene Oakville Sandstone – a major aquifer and uranium host of the Texas coastal plain. Report of Investigations No. 118, Bureau of Economic Geology, The University of Texas at Austin, 63 pp.

Hernandez-Carrillo, N., V. Salazar, F. Garcia-Garcia, and R.T. Brintjes, 2001: Effects of smoke produced by forest fires on warm rain processes in clouds over Mexico and Indonesia. *Preprints*, 15th Conf. on Planned and Inadvertent Weather Modification, American Meteorological Society, Albuquerque, NM. 111-116.

Hopkins, Janie. 1993. Water-quality evaluation of the Ogallala Aquifer, Texas. Report 342, Texas Water Development Board, 41 pp.

Jones, R., 1995: A summary of the 1995 rain enhancement program and a review of the area rainfall and primary crop yield. Report 95-1 of the Colorado River Municipal Water District, 75pp.

Klemt, William B., Gail L. Duffin, and Glenward L. Elder. 1976. Ground-water resources of the Carrizo Aquifer in the Winter Garden area of Texas, Volume 1. Report 210, Texas Water Development Board, 73 pp.

Klemt, W.B., R.D. Perkins, and H.J. Alvarez. 1975, Ground-water resources of a part of central Texas with emphasis on the Antlers and Travis Peak formations. Report 195, Texas Water Development Board, 2 vols.

Knowles, Tommy, Phillip Nordstrom, and William B. Klemt. 1984. Evaluating the ground-water resources of the High Plains of Texas. Report 288, Texas Department of Water Resources, 4 vols.

Koloskov, B., B. Zimin, V. Beliaev, Y. Seregin, A. Chernikov, V. Gladstein, M. Valdes, D. Martinez, C.A. Perez and G. Puente, 1996: Results of experiments of convective precipitation enhancement in the Camaguey experimental area, Cuba. *J. Appl. Meteor.*, **35**, 1524-1534.

Kraus, E.B. and P.A. Squires, 1947: Experiments on the stimulation of clouds to produce rain. *Nature*, **159**, 489-492.

- Land, L.F., C.W. Boning, Lynn Harmsen, and R.D. Reeves. 1983. Streamflow losses along the Balcones Fault Zone, Nueces River Basin, Texas. Water-Resources Investigations Report 83-4368, U.S. Geological Survey, 72 pp.
- Langley, Lon. 1999. Updated evaluation of water resources in part of north-central Texas, 1990-1999. Report 349, Texas Water Development Board, 69 pp.
- Levin, Z., 1992: The role of large aerosols in the rainfall of the eastern Mediterranean. *Proc. WMO Workshop on Cloud Microstructure and Applications to Global Change*. Toronto, Canada, World Meteor. Org. 115-120.
- Levin, Z., E. Ganor, and V. Gladstein, 1996: The effects of desert dust particles coated with sulfate on rain formation in the eastern Mediterranean. *J. Appl. Meteor.*, **35**, 511-523.
- Levin, Z., S. Krichak and T. Reisen, 1997: Numerical simulation of dispersal of inert seeding material in Israel using a three-dimensional mesoscale model (RAMS). *J. Appl. Meteor.*, **36**, 474-484.
- Long, A. B. and A. W. Huggins, 1992: Australian Winter Storms Experiment (AWSE): Supercooled liquid water and precipitation-enhancement opportunities. *J. Appl. Meteor.*, **31**, 1041-1055.
- Loskot, Carol L., William M. Sandeen, and C.R. Follett. 1982. Ground-water resources of Colorado, Lavaca, and Wharton counties, Texas. Report 270, Texas Department of Water Resources, 199 pp.
- Lowry, Robert L. 1960. Monthly reservoir evaporation rates for Texas, 1940 through 1957. Bulletin 6006, Texas Board of Water Engineers, 93 pp.
- Mace, Robert E., Ali H. Chowdhury, Roberto Anaya, and Shao-Chih Way. 2000. A numerical groundwater flow model of the Upper and Middle Trinity Aquifer, Hill Country Area. Open-file Report 00-02, Texas Water Development Board, 62 pp.
- Maclay, R.W. 1995. Geology and hydrology of the Edwards Aquifer in the San Antonio area, Texas. Water-Resources Investigations Report 95-4186, U.S. Geological Survey, 64 pp. + 12 pls.
- Maclay, R.W., and L.F. Land. 1988. Simulation of flow in the Edwards Aquifer, San Antonio region, Texas, and refinements of storage and flow concepts. Water-Supply Paper 2336-A, U.S. Geological Survey, 48 pp.
- Maclay, R.W., and T.A. Small. 1986. Carbonate geology and hydrology of the Edwards Aquifer in the San Antonio area, Texas. Report 296, Texas Water Development Board, 90 pp.
- Marquardt, Glenn, and Eulogio Rodriguez, Jr. 1977. Ground-water resources of the Carrizo

Aquifer in the Winter Garden area of Texas, Volume 2. Report 210, Texas Water Development Board, 467 pp.

- Marwitz, J., 1986: A comparison of winter orographic storms over the San Juan Mountains and the Sierra Nevada, Precipitation Enhancement – A Scientific Challenge. R. R. Braham, Jr., Ed., Netero. Monogr., No. 43, Amer. Meteor. Soc., 109-113.
- Mather, G.K., M.J. Dixon, and J.M. De Jager, 1996: Assessing the potential for rain augmentation --- The Nelspruit randomized convective cloud seeding experiment. *J. Appl. Meteor.*, **35**, 1465-1482.
- Mather, G.K., D.E. Terblanche, F.E. Steffens and L. Fletcher, 1997: Results of the South African cloud-seeding experiments using hygroscopic flares. *J. Appl. Meteor.*, **36**, 1433 –1447.
- Matthews, D.A., 1983: Analysis and classification of mesoscale cloud and precipitation systems. U.S. Dept. of Interior, Bureau of Reclamation Tech. Reprt., Denver, CO, 449pp.
- Meinzer, Oscar E. 1923. The occurrence of ground water in the United States. Water-Supply Paper 489, U.S. Geological Survey, 321 pp.
- Meyers, B.N. 1976. Compilations of results of aquifer tests in Texas. Report 98, Texas Water Development Board, 532 pp.
- Mielke, P.S., Jr., J. G. Medina and C. F. Chappel, 1970: Elevation and spatial variation effects of wintertime orographic cloud seeding. *J. Appl. Meteor.*, **9**, 476-488.
- Mielke, P.S., Jr., L. O. Grant, and C. F. chappell, 1971: An independent replication of the climax wintertime orographic cloud seeding experiment. *J. Appl. Meteor.*, **10**, 1198-1212.
- Muller, Daniel A., and Robert D. Price. 1979. Groundwater availability in Texas: estimates through 2030. Report 238, Texas Water Development Board, 77 pp.
- Mulligan, William F. III, and Rainer K. Senger. 1992. Hydrogeologic investigations of deep ground-water flow in the Chihuahuan Desert, Texas. Report of Investigations No. 205, Bureau of Economic Geology, The University of Texas at Austin, 60 pp.
- Nativ, Ronit. 1988. Hydrogeology and hydrochemistry of the Ogallala Aquifer, Southern High Plains, Texas Panhandle and eastern New Mexico. Report of Investigations No. 177, Bureau of Economic Geology, The University of Texas at Austin, 64 pp.
- Neumann, J. and E. Shimbursky, 1972: On the distribution of a ratio of interest in single- area cloud seeding experiments. *J. Appl. Meteor.*, **11**, 370-375.
- Nirel, R. and D. Rosenfeld, 1994: The third Israeli rain enhancement experiment – An intermediate analysis. *Proceedings of the Sixth WMO Sci. Conf. on Wea. Modif.*, Paestum, Italy, WMO, 569-572.

- Nordstrom, Phillip L. 1982. Occurrence, availability, and chemical quality of ground water in the Cretaceous aquifers of north-central Texas, volume 1. Report 269, Texas Water Development Board, 61 pp.
- Popkin, Barney P. 1971. Ground-water resources of Montgomery County, Texas. Report 136, Texas Water Development Board, 143 pp.
- Pruppacher, H.R., and J.D. Klett, 1978: *Microphysics of Clouds and Precipitation*. D. Reidel Publishing Company, Hingham, Massachusetts. 714 pp.
- Puente, Celso. 1975. Relationship of precipitation to annual ground-water recharge in the Edwards Aquifer, San Antonio area, Texas. Open-File Report 75-298, U.S. Geological Survey, 31 pp.
- Puente, Celso. 1978. Method of estimating natural recharge to the Edwards Aquifer in the San Antonio area, Texas. Water-Resources Investigations Report 78-10, U.S. Geological Survey, 34 pp.
- Rangno, A. L. and P. V. Hobbs, 1987: A re-evaluation of the climax cloud seeding experiment using NOAA published data. *J. Climate Appl. Meteor.*, **26**, 757-762.
- Rangno, A. L. and P. V. Hobbs, 1993: Further analyses of the climax cloud-seeding experiment. *J. Appl. Meteor.*, **32**, 1837-1847.
- Rangno, A.L. and P.V. Hobbs, 1995: A new look at the Israeli cloud seeding experiments. *J. Appl. Meteor.*, **34**, 1169-1193.
- Rangno, A.L. and P.V. Hobbs, 1997: Reply - Comments on A new look at the Israeli cloud seeding experiments. *J. Appl. Meteor.*, **36**, 272-276.
- Rees, Rhys, and A. Wayne Buckner. 1980. Occurrence and quality of ground water in the Edwards-Trinity (Plateau) Aquifer in the Trans-Pecos region of Texas. Report 255, Texas Water Development Board, 41 pp.
- Rogers, R.R., 1976: A Short Course in Cloud Physics. Pergamon Press, Toronto, Canada. 227 pp.
- Rosenfeld, D. and W.L. Woodley, 1989: Effects of cloud seeding in west Texas. *J. Appl. Meteor.*, **28**, 1050-1080.
- Rosenfeld, D., and A. Gagin, 1989: Factors governing the total rainfall yield of continental convective clouds. *Journal of Applied Meteorology*, **28**, 1015-1030.
- Rosenfeld, D. and H. Farbstein, 1992: Possible influence of desert dust on seedability of clouds in Israel. *J. Appl. Meteor.*, **31**, 722-731.

- Rosenfeld, D. and W.L. Woodley, 1993: Effects of cloud seeding in west Texas: Additional results and new insights. *J. Appl. Meteor.*, 32, 1848-1866.
- Rosenfeld, D. and R. Nirel, 1996: The interaction of the desert dust and the southern margins of rain cloud systems in Israel. *J. Appl. Meteor.*, 35, 1502-1510.
- Rosenfeld D. and I. M. Lensky, 1998: Spaceborne sensed insights into precipitation formation processes in continental and maritime clouds. *The Bulletin of American Meteorological Society*, 79, 2457-2476.
- Rosenfeld, D. and W.L. Woodley, 2000: Deep convective clouds with sustained highly supercooled liquid water up to -37.5°C . *Nature*, 405, 440-442.
- Ryder, P.D. 1988. Hydrogeology and predevelopment flow in the Texas Gulf Coast aquifer systems. Water Resources Investigations Report 87-4248, U.S. Geological Survey, 109 pp.
- Ryder, P.D., and A.F. Ardis. 1991. Hydrology of the Texas Gulf Coast aquifer systems. Open-file Report 91-64, U.S. Geological Survey, 147 pp.
- Sassen, K. and H. Zhao, 1993: Supercooled liquid water clouds in Utah winter mountain storms: Cloud-seeding in the Black Hills. Preprints, 6th WMO Scientific conf. On Wea Modif., Paestum, Italy, World Meteorological Organization, Geneva, Switzerland, 541-544.
- Schaefer, V.J., 1946: The production of ice crystals in a cloud of supercooled water droplets. *Science*, 104, 457-459.
- Senger, Rainer K., Edward W. Collins, and Charles W. Kreitler. 1990. Hydrogeology of the Northern Segment of the Edwards Aquifer, Austin region. Report of Investigations No. 192, Bureau of Economic Geology, The University of Texas at Austin, 58 pp.
- Seni, S.J. 1980. Sand-body geometry and depositional systems, Ogallala Formation, Texas. Report of Investigations No. 105, Bureau of Economic Geology, The University of Texas at Austin, 36 pp.
- Sharp, J.M., Jr., R.H. Raymond, S.J. Germait, and J.G. Paine. 1991. Re-evaluation of the causes of subsidence along the Texas Gulf of Mexico coast and some extrapolations of future trends. In *Land Subsidence*, Proceedings of the Fourth International Symposium on Land Subsidence, A.I. Johnson, ed., Publication No. 200, International Association of Hydrological Sciences, pp. 397-405.
- Silverman, B.A., 1986: A review of static-mode seeding of summer cumuli – A review. *Rainfall Enhancement - A Scientific Challenge, Meteor. Monogr.*, No. 43, Amer. Meteor. Soc., 7-24.
- Silverman, B.A., 2000: An independent statistical reevaluation of the South African hygroscopic flare seeding experiment. *J. Appl. Meteor.*, 39, 1373-1378.

- Silverman, B.A. and W. Sukarnjanaset, 2000: Results of the Thailand warm-cloud hygroscopic seeding experiment. *J. Appl. Meteor.*, **39**, 1160-1175.
- Silverman, B.A., 2001: A critical assessment of glaciogenic seeding of convective clouds for rainfall enhancement. *Bull. Amer. Meteor. Soc.*, **82**,
- Simpson, J., G.W. Brier and R.H. Simpson, 1967: Stormfury cumulus seeding experiment 1965: Statistical analysis and main results. *J. Atmos. Sci.*, **24**, 508-521.
- Simpson, J. and W.L. Woodley, 1971: Seeding cumulus in Florida: New 1970 results. *Science*, **173**, 117-126.
- Simpson, J., 1980: Downdraft as linkages in dynamic cumulus seeding effects. *J. Appl. Meteor.*, **19**, 477-487.
- Small, Ted A., John A. Hanson, and Nico M. Hauwert. 1996. Geologic framework and hydrogeologic characteristics of the Edwards Aquifer outcrop (Barton Springs Segment), northeastern Hays and southwestern Travis counties. Water-Resources Investigations Report 96-4306, U.S. Geological Survey, 15 pp. + 1 plate.
- Smith, Gary E., William E. Galloway, and Christopher D. Henry. 1982. Regional hydrodynamics and hydrochemistry of the uranium-bearing Oakville Aquifer (Miocene) of south Texas. Report of Investigations No. 124, Bureau of Economic Geology, The University of Texas at Austin, 31 pp.
- Smith, P., 1963: *J. Appl. Meteor.*, **2**, 324-332.
- Snyder, Fred. 1985. Springs in the Northern Segment of the Edwards Aquifer. In *Edwards Aquifer – Northern Segment, Travis, Williamson, and Bell counties, Texas*, C.M. Woodruff, Jr., Fred Snyder, Laura De La Garza, and Raymond M. Slade, Jr., eds., Guidebook 8, Austin Geological Society, pp. 53-63.
- Sudikoses, P.W., W. Sukarnjanaset, N. Tantipubthong, W.L. Woodley, and D. Rosenfeld, 1998: Cold-cloud microphysical observations in seeded and non-seeded Thai clouds. Preprints, AMS Conf. On Cloud Physics 17-21 August 1998, Seattle, Washington.
- Sundstrom, R.W., and J.W. Hood. 1952. Results of artificial recharge of the ground-water reservoir at El Paso Texas. Bulletin 5206, Texas Board of Water Engineers, 19 pp.
- Super, A. B. and J. A. Heimbach, Jr., 1983: Evaluation of the Bridger Range winter cloud seeding experiment using control gases. *J. Climate and Appl. Meteor.*, **22**, 1989-2011.
- Super, A. B. and J. A. Heimbach, Jr., 1988: Microphysical effects of wintertime cloud seeding with silver iodide over the Rocky Mountains. Part II. Observations over the Bridger Range, Montana. *J. Appl. Meteor.*, **27**, 1151-1165.

Super, A. B., E. W. Holroyd III, and J.T. McPartland, 1989: Winter cloud seeding potential on the Mogollon Rim. Final report, Arizona Department of Water Resources Intergovernmental Agreement No. IGA-88-6189-000-0051, Research and Laboratory Services Division, Bureau of Reclamation, Denver, CO, 173pp.

Texas A&M University. 2001. TexasET. <http://texaset.tamu.edu>, 1 May 2001.

Tzviaon, S., R. Resin, and Z. Levin, 1994: Numerical simulation of hygroscopic seeding in a convective cloud. *J. Appl. Meteor.*, **33**, 252-267.

Thorkildsen, David, and Paul D. McElhaney. 1992. Model refinement and applications for the Edwards (Balcones Fault Zone) aquifer in the San Antonio region, Texas. Report 340, Texas Water Development Board, 33 pp.

Thorkildsen, David, and Robert D. Price. 1991. Ground-water resources of the Carrizo-Wilcox Aquifer in the central Texas region. Report 332, Texas Water Development Board, 60 pp.

Thorkildsen, David, Roger Quincy, and Richard Preston. 1989. A digital model of the Carrizo-Wilcox Aquifer within the Colorado River Basin of Texas. LP-208, Texas Water Development Board, 67 pp.

Veni, George. 1995. Redefining the boundaries of the Edwards (Balcones Fault Zone) Aquifer recharge zone. Proceedings, Water for Texas Conference, Ric Jensen, ed., Texas Water Resources Institute, College Station, pp. 99-107.

Veni, George. 1997. Geomorphology, hydrogeology, geochemistry, and evolution of the karstic Lower Glen Rose Aquifer, south-central Texas. Ph.D. dissertation, Pennsylvania State University, published as Texas Speleological Survey Monographs, 1, Austin, Texas, xi + 409 pp.

Veni, George. 2000. Twenty years/twenty miles: a landmark anniversary at Honey Creek Cave. *The Texas Caver*, 45(5):125-126.

Veni, George. 2001. Hydrogeologic feasibility assessment of the proposed San Felipe Creek flood control dam, Val Verde County, Texas. Report for the U.S. Army Corps of Engineers, Fort Worth District, George Veni and Associates, San Antonio, Texas, 39pp.

Vonnegut, B., 1947: The nucleation of ice formation by silver iodide. *J. Appl. Phys.*, **18**, p. 593.

Walker, Loyd E. 1979. Occurrence, availability, and chemical quality of ground water in the Edwards Plateau region of Texas. Report 235, Texas Department of Water Resources, 336 pp.

Walthour, Steven D., John R. Waugh, Jim O'Connor. 1995. Edwards Aquifer hydrologic report for 1994. Report 95-07, Edwards Underground Water District, 126 pp. + 1 pl.

WMA, 1986: WMA Weather Modification Capability Statement. *J. Wea. Mod.*, **18**, 141-142.

- WMO, 1992: Statement on the Status of weather modification.
- Wood, Warren W., and Ward E. Sanford. 1995. Chemical and isotopic methods for quantifying ground-water recharge in a regional semiarid environment. *Ground Water*, 33(3):458-468.
- Woodley, W.L., 1970: Precipitation results from a pyrotechnic cumulus seeding experiment. *J. Appl. Meteor.*, **9**, 242-257.
- Woodley, W.L., J. Jordan, J. Simpson, R. Biondini, J.A. Flueck, and A. Barnston, 1982: Rainfall results of the Florida Area Cumulus Experiment. 1970-1976. *J. Appl. Meteor.*, **21**, 139-164.
- Woodley, W.L., A. Barnston, J.A. Flueck, and R. Biondini, 1983: The Florida Area Cumulus Experiment's second phase (FACE-2). Part II: Replicated and confirmatory analyses. *J. Climate Appl. Meteor.*, **22**, 1529-1540.
- Woodley, W.L. and M. Solak, 1990: Results of operational seeding over the watershed of San Angelo, Texas. *J. Wea. Mod.*, **22**, 30-42.
- Woodley, W.L. and D. Rosenfeld, 1996: Testing cold-cloud seeding concepts in Texas and Thailand. Part I: Results in Texas to date. In *Proceedings of 13th Conf. On Planned and Inadvertent Weather Modification*, Jan. 28 to Feb. 2, 1996, Atlanta, GA.
- Woodley, W.L., D. Rosenfeld, W. Sukarnjanaset, P. Sudhikoses, S. Ruangsuttinaruparp and W. Khantiganan, 1999a: The Thailand cold-cloud seeding experiment: 1. Physical-statistical design. *Proc. Of 7th WMO Conf. on Wea. Mod.*, 16-22 Feb., 1999, Chiang Mai, Thailand.
- Woodley, W.L., D. Rosenfeld, W. Sukarnjanaset, P. Sudhikoses, S. Ruangsuttinaruparp and W. Khantiganan, 1999b: The Thailand cold-cloud seeding experiment: 2. Results of the statistical evaluation. *Proc. of 7th WMO Conf. on Wea. Mod.*, 16-22 Feb. 1999, Chiang Mai, Thailand.
- Woodley, W.L. and D. Rosenfeld, 2000: Identification of a seeding signature in Texas using multi-spectral satellite imagery. *J. Wea. Mod.*, **32**, 37-52.
- Woodley, W.L. and D. Rosenfeld, 2001: Simpson Monograph (in preparation)
- Woodruff, C.M., Jr. 1984. Water budget analysis for the area contributing to the Edwards Aquifer, Barton Springs Segment. In *Hydrogeology of the Edwards Aquifer—Barton Springs Segment, Travis and Hays counties, Texas*, C.M. Woodruff, Jr., and Raymond M. Slade, Jr., eds., Guidebook 6, Austin Geological Society, pp. 36-42.
- Zipser J., E., and K. R. Lutz, 1994: The vertical profile of radar reflectivity of convective cells: a strong indicator of storm intensity and lightning probability?. *Monthly Weather Review*, **122**, 1751-1759.

Appendix A

Excerpts from Policy Statements Regarding Weather Modification from the American Society of Civil Engineers, the Weather Modification Association, the American Meteorological Society and the World Meteorological Organization

The American Society of Civil Engineers (ASCE, 2000)

The American Society of Civil Engineers (ASCE) supports and encourages the protection and prudent development of the Nation's atmospheric water resources for beneficial uses. Sustain support for atmospheric water resource data collection, research and operational programs, and the careful evaluations of such efforts, including the assessment of extra-area and long-term environmental effects, is essential for prudent development. ASCE recommends that the dissemination of results and findings of all atmospheric water management programs and projects be freely provided to the professional community, appropriate water managers, and to the public.

Atmospheric water resources management capabilities are still developing and represent an evolving technology. The perceptions of some atmospheric professionals, water managers, and most of the public are not based upon current technology. Most atmospheric water management programs and projects in the last 20 years reported significant positive results, but lacked the ability or commitment to fully assess all potential environment effects. Longer-term commitments to atmospheric water resource management research and operational programs are necessary to realize the full potential of this technology.

The Nation's water resources are being stressed by the increasing demands placed upon them by competing demands generated by population growth and environmental concerns. As a result, the Nation has become more sensitive to year-to-year variations in natural precipitation. The careful and self-designed management of atmospheric water resources offers the potential to significantly augment naturally occurring water resources, while minimizing capital expenditures for construction of new facilities. New tools such a polarimetric radar, atmospheric tracer techniques, and advanced numerical cloud modeling now offer means through which many critical questions might now be answered. Continue development of atmospheric water resource management technology is essential, so that it can be made more effective and acceptable, and added to the other management tools available to water resources managers.

Weather Modification Association (WMA, 1986)

Winter Precipitation Augmentation in Continental Areas

Evaluation of both research and operational winter orographic cloud seeding programs indicate that 5-20% seasonal increases in precipitation can be achieved. Detailed analysis of research programs demonstrate that both positive and negative effects of seeding can occur over

short time intervals such as individual storm events. Consequently, it is prudent to adopt seeding techniques and criteria, based upon meteorological conditions, designed to optimize the positive seeding effects during these shorter time intervals thereby maximizing the seasonal increases in precipitation.

Winter Precipitation Augmentation in Coastal Areas

Evaluations of both research and operational wintertime programs conducted in more coastal environments with more limited topographic relief indicate the potential of 5 to as much as 30% increases in seasonal precipitation. Meteorological situations that appear to offer the most potential in these areas are convective in nature. It again appears prudent to adopt meteorologically based seeding guidelines for real-time seeding decision-making in order to maximize the increases in seasonal precipitation.

Summer Precipitation Augmentation

The capability to augment summertime precipitation in an area-wide fashion is promising. Assessments from some operational and some research programs are encouraging especially when a seeding mode is employed which allows selective seeding of individual clouds.

Evaluations of operationally conducted summer precipitation augmentation programs present a difficult problem due to their non-randomized nature and the normally high variability (temporal and spatial) present in summertime rainfall. Recognizing these evaluation limitations, the results of many of these evaluations have indicated a positive area-wide seeding effect in precipitation.

Results are mixed from research programs conducted on summertime cumulus clouds. Part of the resulting uncertainty is due to the variety of climatological and microphysical settings in which experimentation has been conducted. Another important factor is seeding mode, those projects that employed a broadcast mode of dispersal of a glaciogenic seeding material have generally indicated no effect or even decreases in rainfall. Projects which relied upon injection of glaciogenic seeding material directly into clouds that met certain seeding criteria (based essentially upon the stage of development of the cloud) generally indicate positive seeding effects on at least the seeded cloud's rainfall and oftentimes in area-wide rainfall.

The American Meteorological Society (AMS, 1998)

There is growing evidence that glaciogenic seeding (the use of ice-forming materials) can, under certain weather conditions, successfully modify supercooled fog, some orographic stratus clouds, and some convective clouds. Recent research results utilizing both in situ and remote measurements in summer winter field programs provide dramatic though limited evidence of success in modifying shallow cold orographic clouds and single-cell convective clouds. Field studies are beginning to define the frequencies with which responsive clouds occur

within specific meteorological regimes.

Successful treatment of any suitable cloud requires that sufficient quantities of appropriate seeding materials must enter the cloud in a timely, well-targeted fashion. As the need for spatial and temporal targeting has been established, it has become apparent that problems with seeding plume delivery in many early experiments may in part account for the failure of such programs to produce significant results.

Precipitation Increase

There is considerable evidence that, under certain conditions, precipitation from supercooled orographic clouds can be increased with existing techniques. Statistical analyses of precipitation records from some long-term projects indicate that seasonal increases on the order to 10% have been realized. The cause and effect relationships have not been fully documented; however, the potential for increases of this magnitude is supported by field measurements and numerical model simulations. Both show that supercooled liquid water exists in amounts sufficient to produce the observed precipitation increases and could be tapped if proper seeding technologies were applied. The processes culminating in increased precipitation have recently been directly observed during seeding experiments conducted over limited spatial and temporal domains. While such observations further support statistical analyses, they have to date been of limited scope, and thus the economic impact of the increases cannot be assessed.

Recent experiments continue to suggest that precipitation from single-cell and multicell convective clouds may be increased, decreased, and/or redistributed. The response variability is not fully understood, but appears to be linked to variations in targeting, cloud selection criteria, and assessment methods.

Heavy glaciogenic seeding of some warm-based convective clouds (bases at +10°C or warmer) can stimulate updrafts through added latent heat release (a dynamic effect) and consequently increase precipitation. However, convincing evidence that such seeding can increase rainfall over economically significant areas is not yet available.

Seeding to enhance coalescence or affect other warm rain processes within clouds having summit temperatures warmer than about 0°C has produced statistically acceptable evidence of accelerated precipitation formation within clouds, but evidence of rainfall change at the ground has not been obtained.

Although some present precipitation augmentation efforts are reportedly successful, more consistent results would probably be obtained if some basic improvements in seeding methodology were made. Transport of seeding materials continues to be uncertain, both spatially and temporally. Improved delivery techniques and better understanding of the subsequent transport and dispersion of the seeding materials are needed. Current research using gaseous tracers such as sulfur hexafluoride is addressing these problems.

There are indications that precipitation changes, either increases or decreases, can also occur at some distance beyond intended target areas. Improved quantification of these extended

(extra-area) effects is needed to satisfy public concerns and assess hydrologic impacts.

Precipitation augmentation programs are unlikely to achieve higher scientific credibility until more complete understanding of the physical processes responsible for any modification effect is established and linked by direct observation to the specific methodology employed. Continued research emphasizing in situ measurements, atmospheric tracers, a variety of remote sensing techniques, and multidimensional numerical cloud models that employ sophisticated microphysics offer improved prospects that this can be accomplished.

World Meteorological Organization (1992)

Orographic Clouds

In our present state of knowledge, it is considered that the glaciogenic seeding of cloud or cloud systems either formed, or stimulated in development, by air flowing over mountains offers the best prospects for increasing precipitation in an economically viable manner. These types of clouds attract great interest in modifying them because of their potential in terms of water management, i.e., the possibility of storing water in reservoirs or in the snowpack of higher elevation. Numerous research and operational projects conducted since the beginning of weather modification as a science provide the evidence. Statistical analyses suggest seasonal increases (usually over the winter/spring period) on the order of 10 to 15% in certain project areas.

Physical studies using the new technology highlighted above give convincing evidence of the production of an effective seeding agent, the tracing of the agent to supercooled liquid water portions of the cloud, the initiation and development of ice crystals to precipitation size particles, and the fallout of additional precipitation on the mountain slopes in favorable situations over limited areas. Numerical simulation of the processes corroborate the physical studies.

This does not imply that the problem of precipitation enhancement in such situations is solved. Much work remains to be done in pursuit of the goals of strengthening the results and producing incontrovertible statistical and physical evidence that the increases occurred over a wide area, over a prolonged period of time, and with minimum, or positive, extra effects. Existing methods should be improved in the identification of seeding opportunities and the times and situations, in which it is not advisable to seed, thus optimizing the technique and quantifying the results.

Also, it should be recognized that the successful conduct of an experiment or operation is a difficult task that requires competent scientists and operational personnel. It is difficult and expensive to safely fly aircraft in supercooled regions of clouds. Such flying requires experienced crews and aircraft with deicing equipment and sufficient power to carry the heavy ice loads that are sometimes acquired. It is also difficult to target the seeding agent from ground generators or from broad-scale seeding by aircraft upwind of an orographic cloud system.

There is limited physical evidence that deliberate heavy seeding of clouds in certain mountainous situations can result in diversion of snowfall (up to 50 km). However, seeding trials

of this type have not been subjected to statistical or numerical modeling evaluation.

Stratiform Clouds

The seeding of cold stratiform clouds began the modern era of weather modification. Deep stratiform cloud systems (but still with cloud tops warmer than -20°C) associated with cyclones and fronts produce significant amounts of precipitation. A number of field experiments and numerical simulations have shown the presence of supercooled water in some regions of these clouds, and there is accumulating evidence that increased precipitation can be obtained by glaciogenic seeding of such volumes. Shallow stratiform clouds can be made to precipitate, often resulting in clearing skies in the region of seeding. One project using these techniques attempts to allow more sunshine to a city, thus reducing the energy requirements of the metropolitan area. The general applicability of these results --- when, where, and how extensive could the seeding be in various regions of the world --- has not been determined. A worldwide cloud climatology would be useful for this task as well as others list in this report.

Cumuliform Clouds

In many regions of the world, cumuliform clouds are the main precipitation producers. Cumuli (from small fair weather cumulus to giant thunderstorms) are characterized by vertical velocities often greater than 1.0 m s^{-1} and, consequently contain high condensation rates. They can contain the largest condensed water contents of all cloud types and can yield the highest precipitation rates. Their strong vertical currents can suspend particles for a long enough time for them to grow to large sizes (hail, large raindrops).

For these reasons, cumulus clouds appear to be candidates for modification according to both the static and the dynamic seeding hypotheses. Field experiments with in-cloud microphysical measurements experimental seeding trials in several regions have shown that isolated cold cumulus cloud which do not produce rain naturally can be stimulated to produce rain by ice-phase cloud seeding. However, the rainfall amounts from these isolated clouds are very small. Reports of limited success have been obtained from attempts to prove that statistically significant rainfall amounts can be produced on a seasonal basis from these cumuli and larger systems. Attempts to significantly enhance rainfall from cumuliform clouds have concentrated their efforts on systems, which produce rainfall naturally

A long-standing programme to augment rainfall from wintertime cumulus in the eastern Mediterranean is one of the most widely accepted examples of precipitation enhancement (13 to 15% increases) associated with a seeding experiment. Research and operations continue, with recent results indicating the presence of dust affecting the results in one region in a detrimental fashion. Randomized experiments in seeding of warm-based congestus associated with raining thunderstorms have demonstrated the possibility of enhancing rainfall from such clouds by intensive seeding. Extending this result to increasing the rain over an area met with difficulties. Other randomized experiments have reported enhancement of rainfall from warm-based multi-cell thunderstorms; those results are still unclear and under international review. New randomized experiments in rain enhancement are being prepared in several areas.

Enhancement of Rain from Warm Clouds

In most countries, the source of water is precipitation, and in tropical regions that precipitation is generally in the form of convective showers from clouds with tops often not exceeding the height of the freezing level of the so-called warm clouds. In these clouds, the physical processes involved in the initiation and development of rain are condensation, collision-coalescence, and breakup.

Depending on the environment in which these clouds are formed and developed, mainly the type of cloud condensation nuclei (CCN) distribution made available to the system, the growth of large drops can be sufficiently delayed in such a way that the cloud may dissipate before drops grow to precipitation sizes.

The possibility of affecting the condensation/collision-coalescence breakup growth processes by seeding the cloud with either a hygroscopic material (e.g., artificial CCN) or with small water drops, therefore tapping the potential precipitation efficiency of the cloud system, has led to the hypothesis of rain enhancement from warm clouds.

Most of the warm rain processes have been simulated both in laboratory as well as in modeling work. Although favorable from the theoretical point of view, the experiments for rain enhancement from warm clouds conducted up to the present time do not have the necessary physical observations for clear-cut evaluation and possible technology transfer.

APPENDIX B

Classification of the Operational Target Convective Regimes (See text for meaning of rankings) April 15 – September 30, 1999

		Convective Classification							
Date	Pass Times (GMT)	HP	CR	WT	TB	EA	SW	ST	
April									
15	2215	E	E	E	E	E	E	E	
16	2204	1.0	1.0	C	C	C	C	C	
17	2152	Smlc	Smlc	Smlc	Smlc	Smlc	Smlc	Smlc	
18	2142	Smlc	Smlc	Smlc	Smlc	Smlc	Smlc	Smlc	
19	2133	Smlc	Smlc	Smlc	Smlc	Smlc	Smlc	Smlc	
20	2118	1.0	1.0	C	C	C	C	C	
21	2107,2333	Lyrc	Lyrc	Lyrc	Lyrc	Lyrc	Lyrc	Lyrc	
22	2310	E	E	E	E	E	E	E	
23	2043	E	E	E	E	E	E	E	
24	2214	E	E	E	E	E	E	E	
25	2203,2344	1.0	1.0	2.0	1.5	-	-	-	
26	2321	-	C	C	C	C	C	C	
27	2142	Smlc	1.0	1.0	Smlc	Smlc	Smlc	Smlc	
28	2132	Ci	Ci	Ci	Ci	Ci	Ci	Ci	
29	2121	2.5	2.0	2.5	2.5	2.5	2.5	2.5	
30	2105,2333	1.5	1.5	1.0	1.0	-	2.5	-	
May									
1	2054	2.5	2.5	3.0	3.0	4.5	5.0	5.0	
2	2042	C	C	C	C	C	C	C	
3	2031, 2214	E	E	E	E	E	E	E	
4	2203, 2347	C	C	C	C	C	C	C	
5	2152, 2322	2.5	1.0	C	C	C	C	C	
6	2259	C,E	C,E	C,E	C,E	C,E	C,E	C,E	
7	2131	C	C	C	C	C	C	C	
Date	Pass Times (GMT)	HP	CR	WT	TB	EA	SW	ST	
8	2117	C	C	C	Smlc	Smlc	Smlc	Smlc	
9	2105, 2333	1.0	1.0	1.5	2.5	2.5	3.0E	3.0E	
10	2310	C	C	C	C	?	?	?	
11	2042	E	E	E	E	E	E	E	
12	2214	C,E	C,E	C,E	C,E	C,E	C,E	C,E	
13	2202	Ci	Ci	C	Ci	C	C	C	
14	2151, 2321	C	C	?	?	C	C	C	
15	2141	C	1.5	C	Smlc	Smlc	Smlc	Smlc	

16	2131		1.0	1.0	Smlc	Smlc	Smlc	Smlc	Smlc
17	2117		C	2.0	2.0	1.0	2.5	1.0	1.0
18	2104, 2334		Smlc	Smlc	Smlc	Smlc	Smlc	Smlc	Smlc
19	2053, 2311		Smlc	Smlc	Smlc	Smlc	Smlc	Smlc	Smlc
20	2213		Smlc	Smlc	Smlc	Smlc	Smlc	Smlc	Smlc
21	2213		Smlc	Smlc	Smlc	Smlc	Smlc	Smlc	Smlc
22	2202		1.5	C	C	C	C	C	C
23	2151, 2322		C	2.0	2.0	C	C	C	C
24	2138		C	3.0	3.0	2.0	2.0	2.0	2.0
25	2130		2.5	2.0	2.0	2.5	C	C	C
26	2115		2.5	2.5	3.0	1.5	?	?	?
27	2104, 2333		2.0	2.0	2.0	Ci	Smlc	Smlc	Smlc
28	2052, 2235,2311		Smlc	Smlc	Smlc	Smlc	?	Smlc	Smlc
29	2041		E	E	E	E	E	E	E
30	2212		1.5	1.0	1.0	1.0	E	E	E
31	2201		Ci	Ci	1.0	C	C	C	C
June									
1	2149, 2322		Ci	Ci	Ci	1.0	C	C	C
2	2139		1.0	1.0	1.0	1.0	C	C	C
3	2126		1.0	1.0	1.0	Smlc	Smlc	Smlc	Smlc
4	2116		1.5	1.5	1.5	Smlc	Smlc	Smlc	Smlc
5	2103, 2333		Ci	Ci	Ci	Ci	Smlc	Smlc	Smlc
6	2053, 2310		E	E	E	E	E	E	E
7	2223		E	E	E	E	E	E	E
8	2212		1.0	C	C	C	C	C	C
9	2200		1.0	1.5	1.5	C	C	C	C
10	2150, 2322		1.0	1.0	1.0	Smlc	Smlc	Smlc	Smlc
11	2137, 2300		1.0	1.0	2.0	Smlc	Smlc	Smlc	Smlc
12	2126		1.0	1.0	1.5	1.5	2.5	2.5	2.5
13	2114		2.0	2.0	3.0	3.5	2.5	2.5	2.5
14	2102, 2334		?	?	?	2.5	2.5	2.5	2.5
15	2050, 2233,2310		Smlc	Smlc	E	E	E	E	E
16	2222		E	E	E	E	E	E	E
17	2211		C	2.0	3.0	3.5	3.0	3.5	3.5
18	2200		?	1.0	1.5	3.0	2.0	4.0	4.0
Date	Pass Times		HP	CR	WT	TB	EA	SW	ST
19	2114, 2147,2322		2.0	2.5	3.0	3.0	3.0	4.0	4.0
20	2139, 2300		2.5	3.5	5.0	5.0	?	?	?
21	2125		4.5	5.0	5.0	4.5	2.5	2.5	2.5
22	2114		Smlc	Smlc	?	?	4.0	4.0	4.0
23	2101, 2334		Ci	Ci	Ci	Ci	Smlc	Smlc	Smlc
24	2050, 2233,2310		E	E	E	E	E	E	E
25	2039,2146, 2221		E	E	E	E	E	E	E
26	2210		1.5	C	C	C	Smlc	Smlc	Smlc
27	2159		1.5	Smlc	C	C	Smlc	Smlc	Smlc

28	2148		1.5	1.5	1.5	C	Smlc	Smlc	Smlc
29	2138		1.5	1.5	1.5	C	C	C	C
30	2125		C	C	C	C	C	C	C
July 1	2112		C	C	C	C	C	C	C
2	2100		C	C	C	C	C	C	C
3	2049, 2232		C	C	C	E	E	E	E
4	2220		C	C	C	E	E	E	E
5	2209		C	C	?	3.5	Smlc	4.0	4.0
6	2158		3.0	4.0	3.0	C	2.0	4.0	4.0
7	2147		2.5	3.0	3.5	2.5	2.5	?	?
8	2134		C	3.0	3.0	?	2.5	3.0	3.0
9	2123		?	2.5	2.5	C	C	3.0	3.0
10	2111		?	2.5	1.5	2.0	3.0	4.5	4.5
11	2059		C	C	?	?	4.5	5.0	5.0
12	2048		E	E	E	E	E	E	E
13	2219		C	C	?	C	C	C	C
14	2208		C	2.0	C	E	E	E	E
15	2157		2.0	2.0	1.5	C	2.0E	2.5	2.0
16	2145		2.0	2.0	C	C	2.0	C	2.0
17	2134		?	2.5	2.5	C	3.0	3.0	3.0
18	2122		C	4.0	4.0	4.0	3.5	3.5	3.5
19	2111		C	C	C	C	3.0	4.0E	3.0
20	2059		C	C	C	C	E	E	E
21	2047		E	E	E	E	E	E	E
22	2219		C	C	C	C	C	C	C
23	2208		C	C	C	C	C	C	C
24	2157		2.5	C	C	C	C	C	C
25	2146		2.0	C	C	C	C	3.5	4.0
26	2136		C	C	C	C	C	C	C
27	2121		Smlc	Smlc	Smlc	Smlc	Smlc	Smlc	Smlc
28	2109		C	C	C	C	C	C	C
29	2057		C	C	C	C	C	C	C
30	2046, 2229		C	C	C	C	C	C	C
31	2218		2.0	2.0	2.5	2.0	C	C	C
August									
Date	Pass Times		HP	CR	WT	TB	EA	SW	ST
1	2207		2.0	1.5	2.0	C	C	C	C
2	2156		2.5	2.0	2.0	C	C	C	3.0
3	2146		2.5	2.5	2.0	2.5	2.5	3.0	C
4	2135		1.5	3.0	2.5	2.0	2.5	3.0	C
5	2120		E	E	E	E	E	E	E
6	2108		E,C	E,C	E,C	E,C	E,C	E,C	E,C
7	2239		E	E	E,C	E,C	E,C	E,C	E,C
8	2228		2.0	C	C	C	C	C	C
9	2217		?	C	C	C	C	C	C

10	2206		C	C	C	C	C	C	C
11	2155		1.5	C	C	C	C	C	C
12	2145		1.5	1.5	C	C	C	C	C
13	2131		1.5	1.5	2.0	C	C	C	C
14	2119		C	C	2.5	C	C	C	C
15	2107		C	C	C	C	C	C	C
16	2055,2238		E,C	E,C	E,C	E,C	E,C	E,C	E,C
17	2043		E,C	E,C	E,C	E,C	E,?	E,?	E,?
18	2216		C	C	1.5	C	C	C	C
19	2206		1.5	1.5	1.5	2.0	2.0	2.0	2.0
20	2154		1.5	1.5	2.0	2.0	2.0	3.0	3.0
21	2145		BD	BD	1.0	?	?	?	?
22	2130		1.5	C	Ci	TS	TS	TS	TS
23	2118		3.0	Ci	Ci	TS	TS	TS	TS
24	2106		3.5	2.5	Ci	TS	E	E	E
25	2237		E	E	E	E	E	E	E
26	2226		E,C	E,C	E,C	E,C	E,?	E,?	E,?
27	2214		C	C	C	C	Smlc	C	C
28	2203		1.0	1.0	1.5	C	C	C	C
29	2154		2.0	1.5	2.0	1.5	2.0	C	C
30	2143		C	C	1.5	2.0	2.0	2.5	2.0
31	2129		1.5	2.0	2.0	2.0	2.0	2.0	2.0
Sept.									
1	2116		2.5	2.0	2.0	2.5	2.0	2.5	2.0
2	2104		3.0	3.0	3.0	C	2.5	C	3.0
3	2236		E	E	E	E,C	E,C	E,C	E,C
4	2225		2.0	2.0	3.5	2.5	2.5	C	C
5	2216		C	3.0	3.0	C	2.5	3.0	3.5
6	2203		3.0	3.5	3.0	4.0	4.0	4.0	4.0
7	2153		1.5	C	3.0	3.5	3.0	3.5	3.0
8	2142		Smlc	1.5	2.0	4.5	4.0	4.5	4.5
9	2127		C	2.0	2.0	2.0	2.0	3.0	3.5
10	----		BD	BD	BD	BD	BD	BD	BD
11	2103		E,C	E,C	E,C	E,C	E,C	E,C	E,C
12	2235		E	E	E	E	E	E	E
Date	Pass Times		HP	CR	WT	TB	EA	SW	ST
13	2223		C	C	C	3.0	1.5	2.0	2.0
14	2212		2.0	3.5	2.0	3.5	3.5	3.0	3.0
15	2201		BD	BD	BD	BD	BD	BD	BD
16	2150		2.5	2.0	2.5	C	C	C	C
17	2141		1.5	C	C	C	C	C	C
18	2126		2.0	2.0	C	C	C	C	C
19	2113		3.0	2.5	3.0	C	C	C	C
20	2102		E	E	C	E,?	E,C	E,C	E,C
21	2233		E,C	E,C	E,C	E,C	E,C	E,C	E,C

22	2223		C	C	C	C	C	C	C
23	2211		1.0	C	C	C	C	C	C
24	2200		1.0	1.5	1.5	C	C	C	C
25	2150		C	C	1.5	1.5	1.5	C	C
26	2136		C	C	C	C	C	C	C
27	2124		Lyrc	C	C	C	C	C	C
28	2112		Lyrc	Lyrc	Lyrc	C	4.5	5.0	5.0
29	2224		E,C	E,C	E,C	E,C	E,?	E,?	E,?
30	2232		E,C	E,C	E,C	E,C	E,C	E,C	E,C

**Classification of the Operational Target Convective Regimes
April 1 – September 30, 2000**

Convective Classification

Date	Pass Times (GMT)	NP	PG	HP	CR	WT	TB	EA	SW	ST
April 1	2244	1.5	2.0	2.0	2.0	Ci	2.0	Ci	Ci	Ci
2	2233	C	C	C	Ac	Ac	Lyrc	Lyrc	Lyrc	Lyrc
3	2222	Smlc	Smlc	Smlc	Smlc	Smlc	Smlc	Smlc	Smlc	Smlc
4	No Image									
5	2158	C	C	C	C	C	C	C	C	C
6	2145	C	C	C	C	C	C	C	C	C
7	2133	C	C	C	C	C	C	C	C	C
8	2121	C,E	C,E	C,E	C,E	C,E	C,E	C,E	C,E	C,E
9	2252	Ci	Ci	Ci	Ci	Ci	C	C	C	C
10	2241	Ci	Ci	Ci	Ci	Ci	Ci	Ci	Ci	Ci
11	2230	1.0	1.0	1.0	1.0	1.5	1.5	3.0	Smlc	Smlc
12	2219	C	Smlc	Smlc	Smlc	Smlc	2.5	2.5	Smlc	Smlc
13	2209	C	C	C	C	C	C	Smlc	Smlc	Smlc
14	2154	E	E	E	E	E	E	E	E	E
15	2142	1.0	1.5	1.5	Smlc	Smlc	Smlc	Smlc	Smlc	Smlc
16	2129	E	E	E	E	E	E	E	E	E
17	2122	E	E	E	E	E	E	E	E	E
18	2249	C	C	Ci	Ci	1.0	1.0	C	C	C
19	2238	C	C	C	C	1.0	1.0	1.0	1.0	1.0
20	2226	C	C	C	C	C	C	C	C	C
21	2217	Ci	Ci	Ci	Smlc	Smlc	Smlc	Smlc	Smlc	Smlc
22	2203	1.0	1.5	1.0	1.0	1.0	Ci	Smlc	Smlc	Smlc
23	2150	1.5	1.5	1.5	Smlc	Smlc	Smlc	C	C	C
24	2138	C	C	C	C	C	C	C	C	C
25	2126	E	E	E	Smlc	C	C	C	C	C
26	2257	1.0	1.0	1.0	C	C	1.0	C	C	C
27	2246	C	C	C	C	1.0	1.0	C	C	C
28	2234	C	1.0	1.0	C	C	C	C	C	C

29	2223	Smlc	Smlc	1.0	1.0	1.0	Smlc	Smlc	Smlc	Smlc
30	2214	2.0	1.5	1.5	1.0	1.0	Smlc	Smlc	Smlc	Smlc
May										
1	2158	2.5	2.5	2.5	Smlc	C	Smlc	Smlc	Smlc	Smlc
2	2146	Lyrc	Lyrc	1.0	1.0	1.0	Lyrc	Lyrc	Lyrc	Lyrc
3	2134	C	C	C	C	C	C	Smlc	Smlc	Smlc
4	2123	C	C	C	C	C	Smlc	Smlc	Smlc	Smlc
5	2254	E	E	E	E	E	E	E	E	E
6	2242	C	C	1.0	1.0	1.0	1.0	C	C	C
7	2231	Ci	Ci	1.0	1.0	1.0	C	C	C	C
8	2220	Smlc	C	C	C	C	Ci	Ci	Smlc	Smlc
9	2210	C	C	C	C	C	Smlc	Smlc	Smlc	Smlc
10	No Image									
11	2142	C	C	C	C	C	C	Smlc	Smlc	Smlc
12	2130	Ci,E	Ci,E	Ci,E	Ci,E	Smlc	Smlc	Smlc	Smlc	Smlc
13	2118	E	E	E	E	E	E	E	E	E
14	2250	1.0	1.0	1.0	C	C	C	C	C	C
15	No Image									
16	2227	?	?	1.0	1.0	Ci	Ci	Ci	C	C
17	2218	C	C	C	C	Ci	Ci	Ci	Ci	Ci
18	No Image									
19	2150	Smlc	Ci	2.5	2.5	2.5	2.5	3.5	Smlc	3.5
20	2138	1.0	1.5	1.5	Smlc	Smlc	Smlc	Smlc	Smlc	Smlc
21	2309	Smlc	Smlc	1.0	C	1.5	C	C	C	C
22	No Image									
23	2246	C	C	C	C	C	C	C	C	C
24	2235	1.0	1.0	1.0	C	C	C	C	C	C
25	2224	1.0	1.0	1.0	1.0	1.0	1.0	C	C	C
26	2214	1.0	1.0	Smlc	Smlc	Smlc	1.5	1.5	1.5	1.5
27	2158	C	C	C	C	1.0	1.0	Smlc	Smlc	Smlc
28	2146	C	C	C	C	Smlc	Smlc	Smlc	Smlc	4.0
29	2134	C	C	C	C	C	Smlc	Smlc	Smlc	Smlc
30	2305	C	C	C	C	Ci	Ci	C	C	C
31	2254	Ci	Ci	?	Smlc	?	?	Smlc	Smlc	Smlc
June										
1	2243	2.5	2.5	2.5	3.0	3.0	2.5	2.5	2.5	2.5
2	2232	2.5	2.5	3.0	2.5	2.5	Smlc	Smlc	Smlc	Smlc
3	2222	Smlc	Smlc	Ci	3.0	2.0	Smlc	3.5	Smlc	Smlc
4	2206	Smlc	Smlc	Smlc	Smlc	2.5	3.5	3.0	3.5	3.0
5	2154	Smlc	Smlc	Smlc	Smlc	Smlc	Smlc	Smlc	Smlc	2.5
6	2142	Smlc	Smlc	Smlc	C	C	C	C	Smlc	Smlc
7	2313	C,E	C,E	C,E	C,E	C,E	C,E	C,E	C,E	C,E
8	2118, 2301	C,E	C,E	E	C,E	E	E	E	E	E
9	2250	2.0	2.0	2.0	2.0	2.0	4.0	4.0	4.0	4.0
10	2239	3.0	2.5	2.5	C	2.0	4.0	4.0	3.0	3.0

11	2227	1.0	3.0	3.0	3.0	3.5	4.0	4.0	3.5	3.5
12	2218	Ci	Smlc	Ci	Smlc	?	?	?	?	?
13	2202	Smlc	C	C	C	2.0	2.0	2.0	Smlc	Smlc
14	2150	C	C	C	2.5	4.0	5.0	Smlc	Smlc	Smlc
15	2138	C	C	C	C	C	Ci	Ci	Smlc	Smlc
16	2126, 2309	Lyrc	Lyrc	Lyrc	Lyrc	Lyrc	Smlc	Smlc	Smlc	Smlc
17	2258	Ci	Ci	Ci	Ci	Ci	3.0	3.0	2.5	2.5
18	2246	1.5	1.5	3.0	Lyrc	Lyrc	3.5	4.0	4.0	4.0
19	2236	1.0	1.5	1.5	Smlc	Smlc	Smlc	Smlc	Smlc	Smlc
20	2225	1.0	2.5	2.5	C	C	Smlc	Smlc	Smlc	Smlc
21	2210	Smlc	Smlc	Smlc	Smlc	Smlc	C	Smlc	Smlc	Smlc
22	2158	2.0	2.0	2.0	Smlc	Smlc	Smlc	Smlc	Smlc	Smlc
23	2146	2.5	3.0	3.0	3.0	3.0	Ci	Smlc	Smlc	Smlc
24	2134, 2317	Smlc	Smlc	Smlc	Smlc	Smlc	Smlc	Smlc	Smlc	Smlc
25	2122, 2305	1.5	1.5	2.5	2.5	C	C	Smlc	Smlc	Smlc
26	2253	Lyrc	Lyrc	2.0	2.0	Ci	Ci	3.5	4.5	4.5
27	2242	1.5	2.0	3.0	3.0	Smlc	Smlc	Smlc	3.5	3.5
28	2231	2.0	2.0	3.0	3.5	Smlc	Smlc	Smlc	Smlc	Smlc
29	2221	4.0	4.0	4.0	4.0	4.0	Smlc	Smlc	Smlc	Smlc
30	2206	2.0	2.0	2.0	2.5	3.0	Smlc	Smlc	Smlc	Smlc
July										
1	2153	2.5	2.5	2.5	4.5	4.5	C	C	C	C
2	2141	Smlc	C	Smlc	Smlc	Smlc	Smlc	C	C	C
3	2130	C	C	3.0	C	C	C	C	C	C
4	2301	Smlc	C	2.0	C	C	C	C	C	C
5	2250	C	C	C	C	C	C	Smlc	Smlc	Smlc
6	2239	C	C	C	C	Smlc	Smlc	Smlc	Smlc	Smlc
7	2228	Smlc	Smlc	Smlc	Smlc	Smlc	Smlc	Smlc	Smlc	Smlc
8	No Image	-	-	-	-	-	-	-	-	-
9	2201	Smlc	Smlc	Smlc	Smlc	Smlc	Smlc	Smlc	Smlc	Smlc
10	2149	C	C	C	C	C	C	C	C	C
11	2137	Smlc	Smlc	Smlc	C	C	C	C	C	C
12	2125	Smlc	C	1.5	1.5	C	C	C	C	C
13	2257	2.0	2.0	2.0	2.5	2.5	C	C	C	C
14	2246	2.5	2.0	2.0	2.5	2.0	2.0	2.0	C	C
15	2234	Smlc	Smlc	Smlc	2.0	2.0	Smlc	C	C	C
16	2225	Smlc	Smlc	Smlc	Smlc	Smlc	Smlc	Smlc	Smlc	Smlc
17	2209	Smlc	Smlc	Smlc	Smlc	C	C	Smlc	Smlc	Smlc
18	2157	C	C	Ci	C	C	C	Smlc	Smlc	Smlc
19	2328	E	E	E	E	E	E	E	E	E
20	2132	Smlc	Smlc	C	1.5	Smlc	Smlc	Smlc	Smlc	Smlc
21	2304	C	C	C	C	C	C	C	C	C
22	2253	Smlc	Smlc	Smlc	C	C	C	Smlc	Smlc	Smlc
23	2242	Smlc	Smlc	Smlc	Smlc	2.5	1.5	1.5	C	3.0
24	2232	C	C	C	C	Smlc	Smlc	Smlc	Smlc	Smlc

25	No Image	---	---	---	---	---	---	---	---	---
26	2204	C	C	Smle	Smle	Smle	Smle	Smle	Smle	Smle
27	2152	2.0	2.0	2.0	2.0	2.0	C	3.0	Smle	4.0
28	2140	2.0	2.0	2.0	2.0	2.0	Smle	Smle	Smle	Smle
29	2310	Smle	Smle	Smle	Smle	Smle	Smle	Smle	Smle	Smle
30	2300	Smle	Smle	2.5	2.5	2.0	2.0	2.5	2.5	2.5
31	2248	Smle	Smle	Smle	Ci	2.0	3.0	3.0	3.0	3.0
August										
1	2231	Smle	Smle	Smle	Smle	Smle	Smle	3.0	3.0	3.5
2	2227	Smle	Smle	Smle	Smle	Smle	Smle	Smle	Smle	Smle
3	2212	Smle	Smle	Smle	Smle	Smle	Smle	Smle	Smle	Smle
4	2200	Smle	Smle	Smle	Smle	Smle	Smle	Smle	Smle	Smle
5	2147	C	Smle	Smle	Smle	Smle	Smle	Smle	Smle	Smle
6	2135	Smle	Smle	Smle	Smle	Smle	Smle	C	C	C
7	2307	1.5	1.5	2.0	2.0	C	C	C	C	C
8	2255	2.5	2.5	2.5	2.5	2.0	2.0	2.0	2.0	2.0
9	2244	Smle	Smle	Smle	Smle	Smle	Smle	Smle	Smle	Smle
10	2234	Smle	Smle	Smle	Smle	Smle	Smle	Smle	Smle	Smle
11	2223	Smle	Smle	Smle	C	C	C	C	C	C
12	2207	C	C	C	Smle	Smle	C	C	C	C
13	2155	Smle	Smle	Smle	Smle	Smle	Smle	Smle	Smle	Smle
14	2143	C	C	C	C	C	C	C	C	C
15	2314	Smle	Smle	Smle	Smle	Smle	Smle	Smle	Smle	Smle
16	2302	C	C	C	C	C	C	C	C	C
17	2251	Smle	Smle	Smle	Smle	Smle	C	C	C	C
18	2240	Smle	Smle	Smle	Smle	Smle	Smle	Smle	Smle	Smle
19	2229	Smle	Smle	Smle	C	C	C	Smle	Smle	Smle
20	2214	Smle	Smle	Smle	C	C	C	Smle	Smle	Smle
21	2202	Smle	C	C	C	C	Smle	3.5	3.5	3.5
22	2150	Smle	Smle	Smle	Smle	Smle	Smle	Smle	Smle	Smle
23	2138	Smle	Smle	Smle	Smle	Smle	Smle	Smle	Smle	Smle
24	2309	Smle	Smle	Smle	Smle	Smle	Smle	Smle	Smle	Smle
25	2258	Smle	Smle	Smle	Smle	Smle	3.0	3.5	3.5	Smle
26	2247	Smle	Smle	Smle	Smle	Smle	Smle	Smle	Smle	Smle
27	2235	Smle	Smle	Smle	Smle	Smle	Smle	Smle	Smle	Smle
28	2225	Smle	Smle	Smle	Smle	Smle	Smle	Smle	Smle	Smle
29	2209	Smle	Smle	Ci	Smle	Smle	Smle	Smle	Smle	Smle
30	2157	E	E	E	E	Smle	C	C	C	C
31	2146	E,Ci	E,Ci	E,Ci	E,Ci	E,Ci	C	C	C	C
Sept										
1	2134, 2317	Smle	Smle	Smle	Smle	Smle	Smle	Smle	Smle	Smle
2	2122, 2305	1.5	1.5	1.5	E	E	E	E	E	E
3	2253	Smle	Smle	Smle	Smle	Smle	Smle	Smle	Smle	Smle
4	2242	Smle	Smle	Smle	Smle	Smle	Smle	Smle	Smle	Smle
5	2231	Smle	Smle	Smle	Smle	Smle	Smle	Smle	Smle	Smle

6	No Image										
7	2204	Smlc	Smlc	Smlc	Smlc	Smlc	Smlc	Smlc	Smlc	Smlc	Smlc
8	2152, 2335	Smlc	Smlc	Smlc	Smlc	Smlc	Smlc	Smlc	Smlc	Smlc	Smlc
9	2140, 2323	E	E	E	E	E	E	E	E	E	E
10	2129, 2312	Smlc	Smlc	Smlc	Smlc	Smlc	Smlc	Smlc	Smlc	Smlc	Smlc
11	2300	Smlc	Smlc	Smlc	1.5	1.5	Smlc	Smlc	Smlc	Smlc	Smlc
12	2249	Smlc	Smlc	Smlc	1.5	1.5	1.5	1.5	Smlc	Smlc	Smlc
13	2238	Smlc	Smlc	Smlc	Smlc	Smlc	1.5	2.5	2.0	2.5	2.5
14	2227	C	C	Smlc	Smlc	1.5	1.5	1.5	1.5	1.5	1.5
15	No Image										
16	2159	Smlc	Smlc	Smlc	Smlc	Smlc	Smlc	Smlc	Smlc	Smlc	Smlc
17	2147, 2330	Smlc	Smlc	Smlc	Smlc	Smlc	Smlc	Smlc	Smlc	Smlc	Smlc
18	2319	1.0	1.0	1.0	C	C	C	C	C	C	C
19	2307	C	C	C	1.0	1.0	1.0	Smlc	Smlc	Smlc	Smlc
20	2256	Smlc	Smlc	Smlc	Smlc	Smlc	Smlc	Smlc	Smlc	Smlc	Smlc
21	2244	Smlc	Smlc	Smlc	Smlc	Smlc	Smlc	4.0	4.0	4.0	4.0
22	2234	1.5	1.5	1.5	Smlc	Smlc	Smlc	Smlc	Smlc	Smlc	Smlc
23	2219	1.5	1.5	1.5	2.5	3.0	Smlc	Smlc	Smlc	Smlc	Smlc
24	2349	E	E	E	E	E	E	E	E	E	E
25	2154	C	C	C	C	C	C	C	C	C	C
26	2142, 2325	C	C	C	C	C	C	C	C	C	C
27	2314	Smlc	Smlc	Smlc	Smlc	Smlc	Smlc	Smlc	Smlc	Smlc	Smlc
28	2302	C	C	Smlc	C	C	C	C	C	C	C
29	2251	Smlc	Smlc	Smlc	Smlc	Smlc	Smlc	Smlc	Smlc	Smlc	Smlc
30	2241	Smlc	Smlc	Smlc	Smlc	Smlc	Smlc	Smlc	Smlc	Smlc	Smlc

APPENDIX C

Results of Monthly and Seasonal Gauge vs. Radar Rainfall Comparisons in the Texas Panhandle

William L. Woodley
Woodley Weather Consultants
Littleton, Colorado

Roni Drori and Daniel Rosenfeld
Hebrew University of Jerusalem
Jerusalem, Israel

Scott Orr
High Plains Underground Water Conservation District
Lubbock, Texas

George Bomar
Texas Natural Resource Conservation Commission
Austin, Texas

Abstract. Gauge and radar estimates of monthly and seasonal (April-September in 1999 and 2000) convective rainfall were compared for a large network in the Texas Panhandle. In 2000, the network, covering approximately $3.6 \times 10^4 \text{ km}^2$ ($1.4 \times 10^4 \text{ mi}^2$), contained 505 fence-post rain gauges with individual, subterranean, collector reservoirs at a density of one gage per 72 km^2 (29 mi^2). These were read monthly to produce area-averaged rain totals, obtained by dividing the gauge sums by the number of gauges in the network. The gauges were not read in September 2000 because of negligible rainfall. Comparable radar-estimated rainfalls for the same time periods were generated using merged, base-scan, 15-min, NEXRAD radar reflectivity data supplied by the National Weather Service through WSI, Inc. and the Global Hydrology Resource Center.

The gauges vs. radar comparisons were made on the basis of rain patterning and area averages. The Z-R relationship used to relate radar reflectivity (Z) to rainfall rate (R) was $Z = 300R^{1.4}$, which is the equation used in standard NEXRAD practice. Because all of the rain gauges could not be read on a single day, the gauges do not provide an absolute basis of reference for comparison with the radar estimates, which were made in time periods that matched the average date of the gauge readings. The gauge and radar monthly rain patterns agreed in most instances, although the agreement in August 2000 was poor. The monthly correlations of gauge and radar rain amounts were 0.86 in 1999, 0.96 in 2000 and 0.93 for the two years combined. The radar tended to underestimate heavy rain months and overestimate those with light rain. The radar overestimate for months with light

rain may be due to evaporative losses beneath the level of the radar scan as the drops fell through dry air to the ground.

The period of comparison affected the results. The area-average gauge vs. radar comparisons made on a monthly basis agreed to within 20% on 5 of the 11 months compared. Upon comparison of the gauge and radar rainfalls on a two-month basis to diminish the impact of variations in the date of the gauge readings, it was found that all but one of the five comparisons was within 5%. The exception (April/May 1999) differed by 16%. The seasonal gauge and radar estimates in 1999 and 2000 agreed to within 4% and 8%, respectively, which is extraordinary considering the uncertainties involved. Thus, the longer the period of comparison the better the agreement appeared to be. It is concluded that the use of radar in Texas can provide an accurate representation of rain reaching the ground on a monthly and seasonal basis.

1. DEDICATION

This paper is dedicated to the memory of Mr. A. Wayne Wyatt (Figure 1), past Manager of the High Plains Underground Water Conservation District (HPUWCD), who died suddenly on December 5, 2000. Mr. Wyatt assumed his duties as general



Figure 1. Photograph of A. Wayne Wyatt, manager of the High Plains Underground Water Conservation District No.1 since 1978 until his death. During the latter portion of his tenure, Wayne promoted the investigation of cloud seeding for enhancing the water resources of the Texas Panhandle. He is also responsible for the

implementation of the rain gauge network used in this study.

manager of the High Plains Water District on February 1, 1978 and remained in this position until his death. Besides overseeing the Water District's many programs and activities, including the installation of the gauge network used in this study, he was serving as chairman of the Llano Estacado Regional Water Planning Group at the time of his death. The regional water-planning group is charged with developing a 50-year water plan for a 21-county area in the southern high plains of Texas. Wayne was a prime mover for the investigation of the potential of cloud seeding for enhancing the water resources for the area, and oversaw the operational cloud seeding effort under the sponsorship of the HPUWCD since its inception in 1997. In addition, he also kept a close watch on state and federal legislative issues that could affect ground water use within the region. During his 43-year career in ground water management, many peer groups and professional organizations honored him.

2. INTRODUCTION

The measurement of precipitation is of concern to many interests and disciplines. Although simple conceptually, accurate measurement of precipitation is a difficult undertaking, especially if the precipitation takes the form of convective showers having high rain intensities, strong gradients and small scale. Rain gauges are the accepted standard for point rainfall measurement, although individual gauge readings are subject to errors in high winds and in turbulent flow around nearby obstacles. Rain gauges do not, however, provide accurate measurements of convective rainfall over large areas unless they are distributed in sufficient density to resolve the salient convective features. In some circumstances this might require hundreds, if not thousands, of rain gauges (Woodley et al., 1975).

Radar is an attractive alternative for the estimation of convective rainfall, because it provides the equivalent of a very dense gauge network. Radar estimation of rainfall is, however, a complex undertaking involving determination of the radar parameters, calibration of the system, anomalous propagation of the radar beam, ground clutter and "false rainfall", concerns about beam filling and attenuation, and the development of equations relating radar reflectivity (Z) to rainfall rate (R), where radar reflectivity is proportional to the sixth power of the droplet diameters in the radar beam. A good source for discussion of these matters is Radar in Meteorology (Atlas, 1990)

Some scientists have spent virtually their entire careers perfecting radar rainfall estimates, but even then the results are not always to their liking. Variability due to calibration uncertainties and changes of rain regimes must be accounted for by comparisons with rain gauges, especially for

rainfall measurements that are based on reflectivity-only radar data.

Woodley et al. (1975) provide an extensive discussion of the trade-offs in the gauge and radar estimation of convective rainfall and discuss the combined use of both to increase the accuracy of the rain measurements. Radar provides a first estimate of the rainfall and rain gauges, distributed in small but dense arrays, are used to adjust the radar-rainfall estimates.

Accurate representation of the rainfall is crucial to the evaluation of cloud seeding programs for the enhancement of convective rainfall. Some have used rain gauges over fixed targets; others have used radar for the estimation of rainfall from floating targets (e.g., Dennis et al., 1975; Rosenfeld and Woodley, 1993; Woodley et al., 1999), while still others have made use of radar and gauges in combination (e.g., Woodley et al., 1982, 1983). The operational cloud seeding programs of Texas (Bomar et al., 1999), which numbered nine as of the summer 2000 season (Figure 2), make extensive use of TITAN-equipped C-band radars to conduct project operations and for subsequent evaluation. For those using radar there is the nagging uncertainty about the accuracy of their radar-rainfall estimates. This is addressed in this paper.

The initial intention was to use the C-band project radars to generate rain estimates for comparison with rain gauges that provide readings on a daily basis, but this proved to be unfeasible. None of the projects operate their radars round-the-clock, meaning that some rainfalls are not measured, thereby making it impossible to make daily comparisons. Further, the project radars may suffer from other problems, including attenuation of the beam in heavy rain and ground clutter, which is sometimes

interspersed with rain events, especially during their later stages. Because this “false rainfall” cannot not be removed objectively without a removal algorithm, it is a potential source of error in estimating the rainfall to be compared with the rain gauges. In addition, non-standard calibration procedure between the different radars can result in systematic differences in the Z-R relations that needed to be applied for unbiased rainfall measurements.

At this point it was obvious that a change in plan had to be made. If rainfall were to be estimated around-the-clock in Texas and spot-checked by comparison with rain gauges, it would have to be done with a different radar system. An obvious possibility was the NEXRAD radar systems that are distributed about the state. These are S-band radars, which do not attenuate appreciably in heavy rain, and they are operated continuously in a volume-scan mode unless they are down for maintenance. In addition, the NEXRAD radars have a clutter-removal algorithm that eliminates most of the false rainfall produced during periods of anomalous propagation.

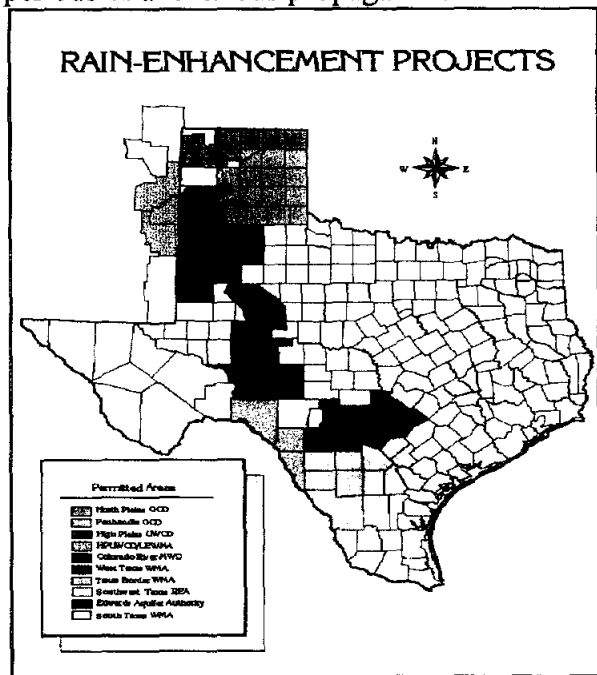

Figure 2. Map showing the nine operational cloud-seeding targets in existence in Texas as of the summer of 2000.

The availability of gauge data for this effort also posed a serious challenge. Upon looking for rain-gauge data from dense arrays big enough to resolve large convective systems on a daily basis, nothing suitable was found. It was obvious immediately, however, that it would be possible to make gauge vs. radar rainfall comparisons on a monthly and seasonal basis, using a unique network installed in the High Plains target (brown area in the Texas Panhandle shown in Figure 2). It would at least be possible, therefore, to assess the accuracy of long-term radar-rainfall estimates. These results could then be used for the benefit of the seeding projects and for others interested in the accuracy of the NEXRAD rainfall estimates.

3. GAUGE NETWORK AND DATA

Over the course of several years the High Plains Underground Water Conservation District (HPUWCD) has been instrumenting its District with fence-post rain gauges having tubing to individual, sealed, subterranean, collector reservoirs as shown in Figure 3. Evaporation is negligible under such circumstances. The network had 458 gauges in 1999 and 505 gauges in 2000 as shown in Figure 4. The gauge density in 2000 was one gauge every 72 km² (i.e., 1 per 29 mi²), which would have been sufficient to resolve most individual convective systems if the gauges had had recording capability.

District personnel read and emptied the gauge reservoirs once per month, but they could not be read on one day. Typically, it took two to three days to read all of the gauges. This injected some uncertainty and noise into the gauge measurements of

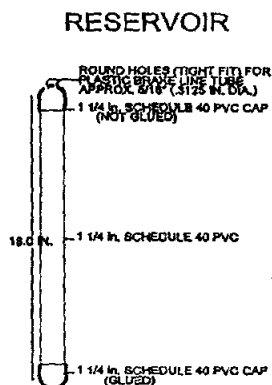
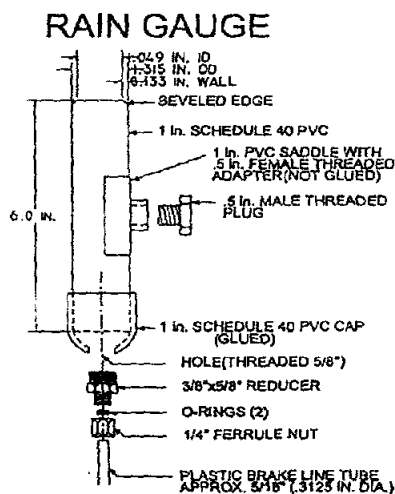
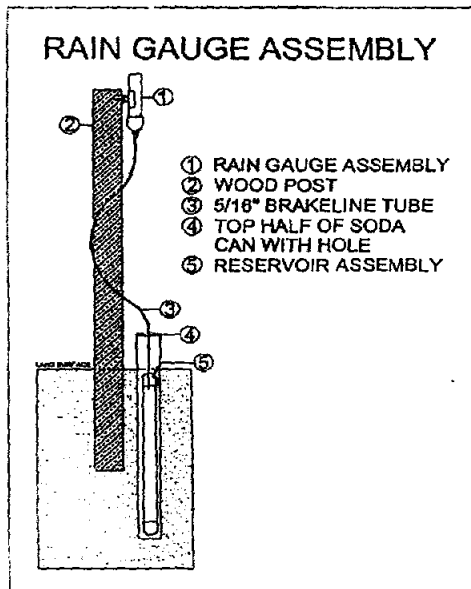

Figure 3. Design of the rain gauge system developed at the HPUWCD. a) the rain gauge assembly, b) the rain gauge, and c) the reservoir.

monthly rainfall, since the rain falling into gauges after they had been read would be ascribed to the following month whereas same rain falling into gauges that had not yet been read would be ascribed to the current month. Thus, the gauge measurements cannot be considered an absolute basis of reference for comparison with the radar rainfall inferences.

The monthly gauge readings were made in the period April through September 1999 and April through August 2000. The gauges were not read in September 2000 because of miniscule rainfall --- 1.52 mm (0.06 in) area-average as measured by the radar --- and this month is not included in the gauge vs. radar comparisons. The gauge area means were computed by two methods. In the first method all gauge values were summed and divided by the total number of gauges in the network. The second method involved performing an isohyetal analysis, planimetrying the areas between the rain contours, the calculation of summed rain volumes, and the calculation of the area average by dividing the rain volume by the network area. Although the results for both methods are presented, the first method is preferred because of its objectivity. The gauge products and results are presented in Section 5.0, dealing with the gauge vs. radar comparisons.

4. THE NEXRAD RADAR, DATA AND PRODUCTS

Investigation of the availability of NEXRAD data revealed a source at WSI, Inc., which was made available through NASA's Global Hydrology Resource Center (GHRC). WSI Inc., receives instantaneous reflectivity data from the operational National Weather Service (NWS) radar sites located in the United States. These sites

include S-band (10 cm) WSR-88D radars. The national and regional radar images are created from a mosaic of radar data from more than 130 radar sites around the United States, including new NEXRAD Doppler radar sites as they become available. A merged data set for the continental United States (CONUS) is produced by WSI, Inc., every 15 minutes, which is subsequently broadcast to the GHRC. The broadcast is

These base-scan 5-dBZ thresholds reflectivity data were secured for this study for the 1999 and 2000 April-September convective seasons and daily rainfall (0700 CDT on the day in question to 0659 CDT the next day) was obtained by converting the reflectivity data into rainfall rates using the Z-R relation ($Z = 300R^{1.4}$) proposed by Woodley et al. (1975) and now used as standard NEXRAD practice. Rain rates greater than 120 mm/hr were truncated to that value. The application of the Z-R relation to the threshold reflectivity values every 5 dBZ is not expected to compromise appreciably the accuracy over large space-time domains, given the fact that even a single threshold was shown to provide a remarkable agreement with the exact integration of the full dynamic range of intensities (Doneaud et al., 1984; Atlas et al., 1990; Rosenfeld et al., 1990). The rain totals were obtained for all of Texas and for various subareas, including the gauged High Plains network.

RAIN GAUGE LOCATIONS FOR 2000

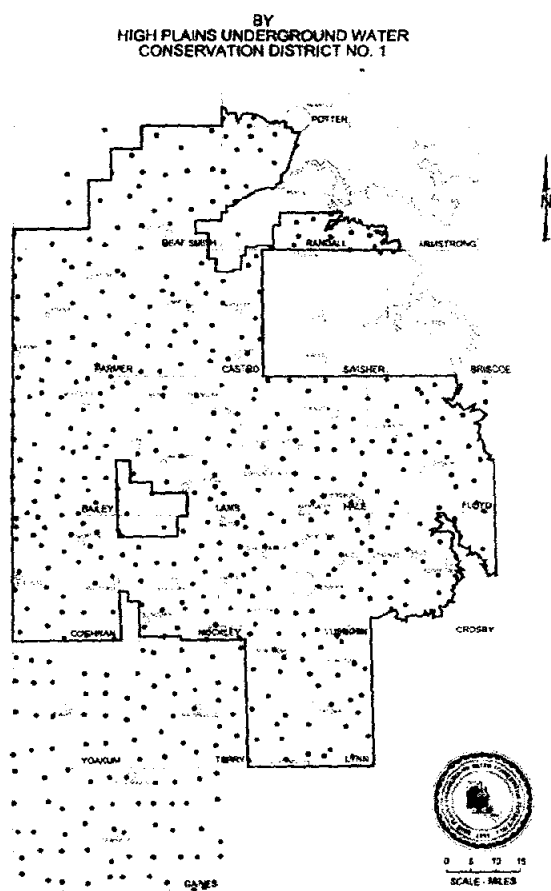

Figure 4. Map of the HPUWCD rain gauge network showing the location of its 505 gauges for the 2000 season

ingested at the GHRC and stored therein at 16 reflectivity levels from 0 to 75 dBZ, every round 5 dBZ. This product has the designation of NOWrad (TM), a registered trademark of the WSI Corporation.

The GHRC also generates its own rainfall product for the United States. For reasons unknown at this writing the GHRC rainfalls were found to be too high relative to the High Plains rain gauges by factors of 4 to 5, and with poor spatial matching, prompting us to do the integration of the 15-minute reflectivity maps, which is the basis for the analyses in this study.

5. RESULTS

The gauges vs. radar comparisons were made on the basis of rain patterning and area averages. Because of a day or two variations when the gauges were read (discussed earlier), the gauges do not provide an absolute basis of reference for comparison with the radar estimates. The gauge and radar maps for the seasonal rainfalls in 1999 and 2000 are presented in Figures 5-8.

Comparable products were produced for each month, but they are not shown here because of space and cost considerations. The gauge maps are isohyetal analyses of

the plotted gauge data (not shown), which were provided by the HPUWCD. The units are in inches.

RAINFALL FOR APRIL - SEPTEMBER 1999
(CONTOURED IN INCHES)
BY
HIGH PLAINS UNDERGROUND WATER
CONSERVATION DISTRICT NO. 1

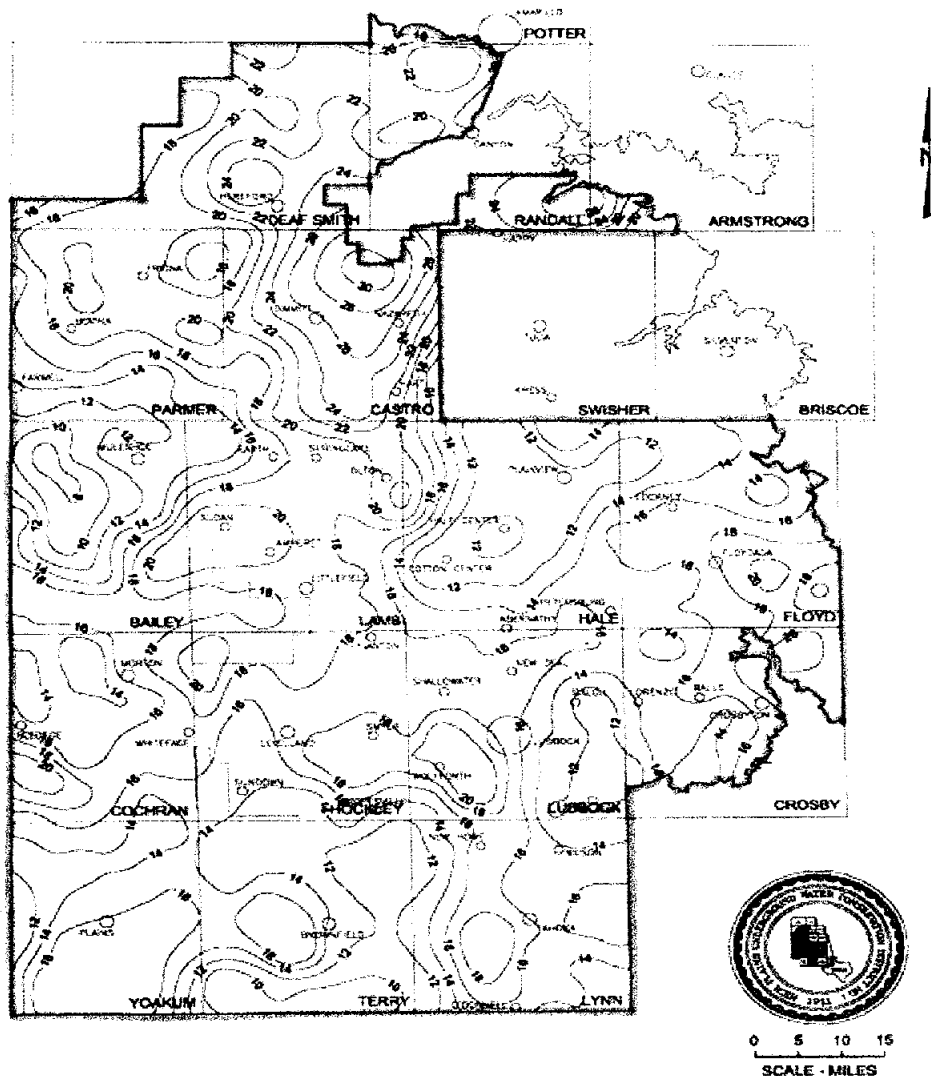
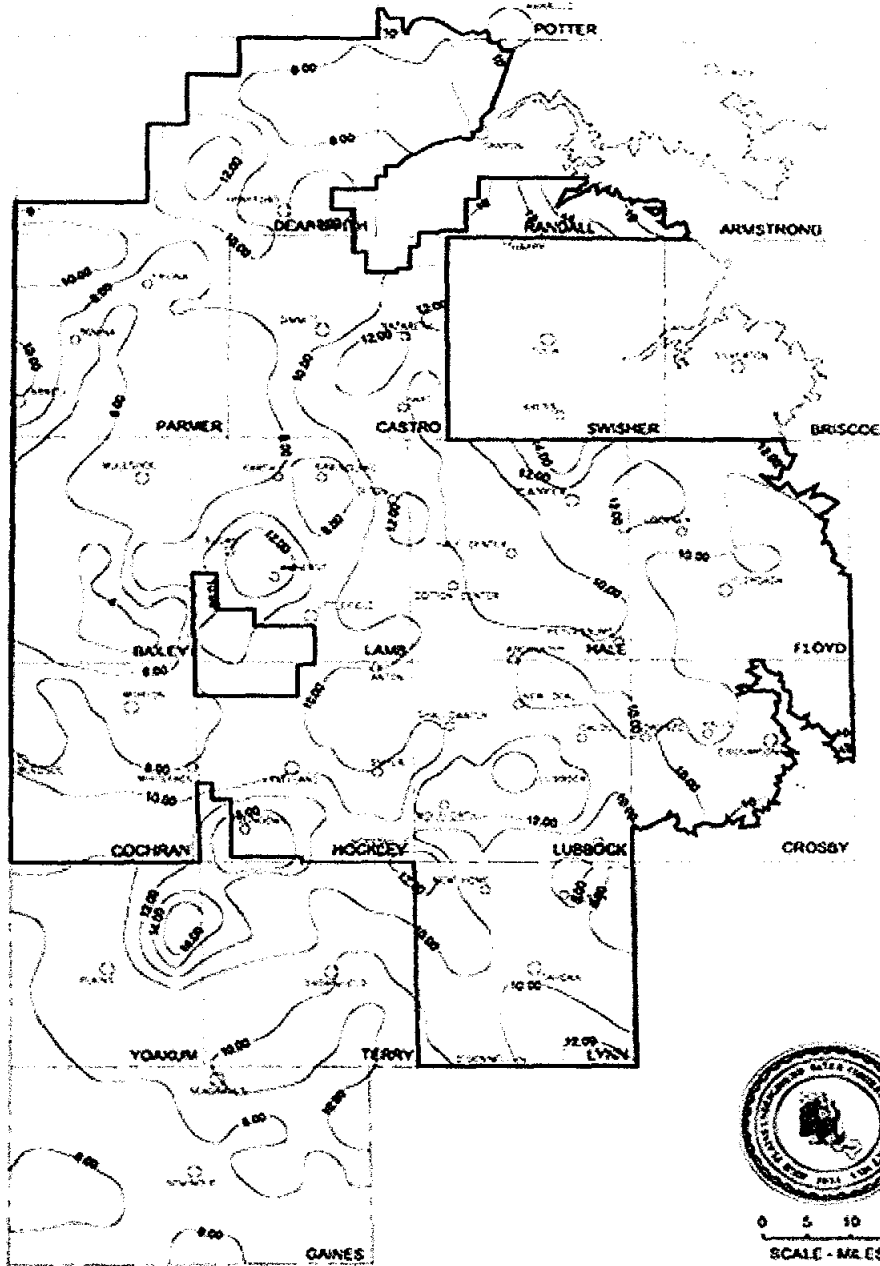

Figure 5. Isohyetal analysis (inches) in the seasonal (April through September) rainfall in 1999. The gauge maps were produced six months to a year prior to this study by personnel at the High Plains Underground Water Conservation District.



Figure 6. Map of the radar-estimated rainfalls (mm) for the 1999 season (April through September). The colorized pixels in the radar maps can be converted to rainfall in mm by using the legend at the bottom of the figure.

RAINFALL FOR APRIL - AUGUST 2000
 (CONTOURED IN INCHES)
 BY
 HIGH PLAINS UNDERGROUND WATER
 CONSERVATION DISTRICT NO. 1



Figures 7. Isohyetal analysis (inches) in the seasonal (April through August) rainfall in 2000. Because of negligible rainfall, the rain gauges were not read in September 2000.

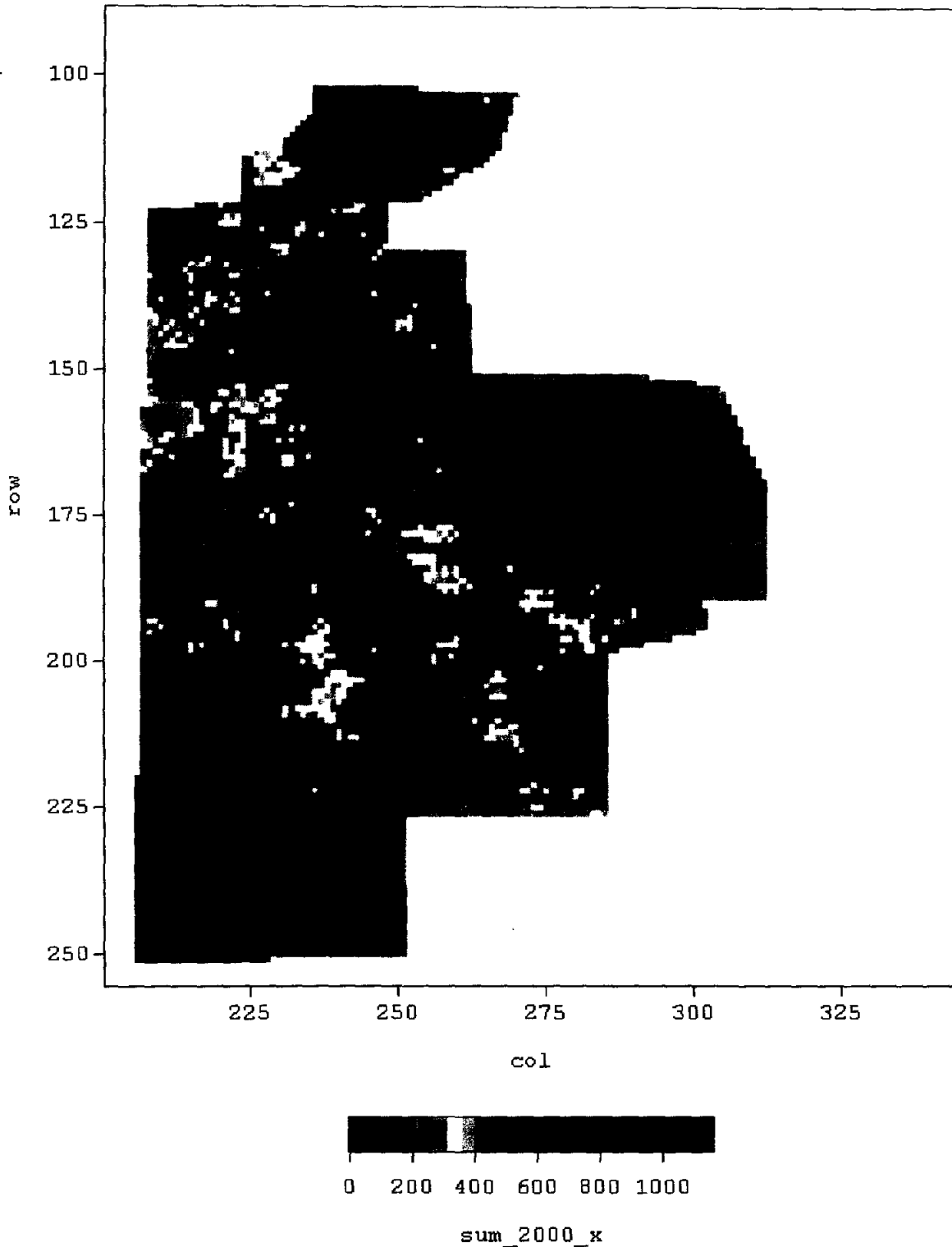

Figure 8. Map of the radar-estimated rainfalls (mm) for the 2000 season (April through August). The rainfall was negligible in September 2000). The colorized pixels in the radar maps can be converted to rainfall in mm by using the legend at the bottom of the figure.

The radar maps are colorized pixels, which can be related to rain depths in mm using the scale at the bottom of the figure. The first three authors generated these radar products. The independent production of the gauge and radar maps accounts for the differing rainfall units, where 1 inch is 25.4 mm.

The first step in the assessment was comparison of the rain patterning and maxima. This was a subjective process by which the agreement in each month was rated on a scale from 0 to 10, where 0 means that there was no agreement and 10 indicates perfect agreement. The results are presented in Table 1. Although the results are good to excellent in most months, there were a few serious mismatches of maxima, especially in June 2000 (not shown) along the central portion of the Texas-New Mexico border. At first it was thought that this might be the result of heavy rain during the period the gauges were read, resulting in the errors discussed earlier. Only after all of the analyses had been completed was it determined that a gauge reading of 6 inches in the area of radar maximum had been thrown out as unreasonable prior to the isohyetal analysis, because it was much higher than the surrounding gauge readings. Upon adding this 6-inch maximum to the pattern, the gauge vs. radar disparity is reduced, but not eliminated entirely.

Quantification of the gauge vs. radar comparisons is presented in Table 2. Before making the comparisons the rainfall that appears in the eastern finger (covering 585 km²) of the network on the gauge maps was subtracted from the overall gauge totals. This was necessary because the radar did not estimate rainfall for this small area.

The gauge sums divided by the number of network gauges served as the standard for the gauge vs. radar comparisons. The

correlation of the monthly gauge and radar rain estimates was 0.86 in 1999, 0.96 in 2000 and 0.93 for the two years combined. The radar tended to underestimate heavy rain months and overestimate those with light rain with the crossover point at 50mm. The radar overestimate for months with light rain may be due to evaporative losses beneath the level of the radar scan as the drops fell through dry air to the ground.

The area-average gauge vs. radar comparisons agreed to within 20% on 5 of the 11 months compared (Table 2). The gauges were not read in September 2000 because of negligible rainfall. Agreement was appreciably better in months with heavy rain. The longer the period of comparison the better is the agreement. The seasonal gauge and radar estimates in 1999 and 2000 agreed to within 4% (i.e., G/R = 1.04) and 8% (i.e., G/R = 0.92), respectively.

Note that the G/R values oscillate around 1.0 from one month to the next and that the "all months" G/R values are nearly 1.0. This suggests that a portion of the monthly differences can be explained by the gauges measuring some rains not observed by the radar and vice versa. As discussed earlier, this can occur when it rains heavily during the two to three days that it takes to read all of the rain gauges. If this is true, the oscillating errors should diminish when the comparisons are done for periods of two months or longer.

This hypothesis is tested in Table 3 and the results are dramatic. Using method 1 as the standard, note that four of the five two-month comparisons agree to within 5%, and that in the lone exception the gauges and radar differ by only 16%.

Table 1

Subjective Comparison of the Gauge and Radar Rainfall Patterning
(Scale of 0 to 10 where 0 = no agreement and 10 = perfect agreement)

Month(s)	Pattern	Maxs/Mins	Comments
April 1999	8	6	Good correspondence
May 1999	7	6	Good overall agreement, few maxima do not match
June 1999	8	8	Very good agreement everywhere in a heavy rain month
July 1999	9	9	Excellent overall agreement
August 1999	8	7	Very good overall agreement except for radar maximum not on gauge map
September 1999	9	9	Excellent overall agreement
April-Sept 1999	9	9	Excellent overall agreement
April 2000	8	8	Very good agreement except for a few mismatches
May 2000	9	6	Excellent pattern match but radar maxima greater than gauge maxima
June 2000	6	5	General agreement but poor match of rain maximum, especially along New Mexico border
July 2000	6	5	General pattern match, but some serious mismatches
August 2000	5	4	Poor match of pattern and maxima
April-Sept 2000	8	8	Very good overall agreement except for poor match of maximum along central Texas-New Mexico border

Table 2
Comparison of Gauge and Radar-Estimated Rainfalls (in mm) for the
High Plains Rain Gauge Network

Month	Gauge Mean (1)	Gauge Mean (2)	Radar Mean	(G/R) ¹	(G/R) ²
		1999	Season		
April	97.14	97.06	68.26	1.42	1.42
May	69.58	70.41	75.60	0.92	0.93
June	114.63	117.78	101.92	1.12	1.16
July	44.79	34.02	59.81	0.75	0.57
August	34.44	35.82	46.95	0.73	0.76
September	60.17	56.38	50.42	1.19	1.12
April-Sept	420.75	411.47	402.96	1.04	1.02
		2000	Season		
April	25.85	24.14	14.59	1.77	1.65
May	9.62	7.16	21.92	0.44	0.33
June	103.52	95.30	92.57	1.12	1.03
July	56.13	49.37	64.31	0.87	0.77
August	2.01	1.42	18.57	0.11	0.08
September	NA	NA	1.53	---	---
April-Aug	197.13	177.39	213.49	0.92	0.83
1999 & 2000	617.88	588.86	616.45	1.002	0.96

Table 3
Two-Month Comparisons of Gauge and Radar-Estimated Rainfalls (in mm) for the
High Plains Rain Gauge Network in 1999 and 2000

Months	Gauge Mean (1)	Gauge Mean (2)	Radar Mean	(G/R) ¹	(G/R) ²
April/May 99	166.72	167.47	143.86	1.16	1.16
June/July 99	159.42	151.80	161.73	0.99	0.94
Aug/Sept 99	94.61	92.20	97.37	0.97	0.95
April/May 2000	35.47	31.30	36.51	0.97	0.86
June/July 2000	159.65	144.67	156.88	1.02	0.92

6. CONCLUSIONS

The results of this study suggest that NEXRAD data can be used to provide accurate measurements of monthly and seasonal convective rainfall in Texas. Contrary to our expectations, no changes in the Z-R equation appear warranted. The accuracy of the radar-rainfall inferences is certain to decrease as the period of comparison is decreased to individual days or even shorter time frames. This can be readily documented using the NEXRAD data, provided suitable rain gauges in dense arrays can be found to serve as a basis for reference.

As mentioned before, the project radars are poorly equipped for area rainfall measurements. Their best use would appear to be in the conduct of seeding operations, particularly in the real-time assessment of the properties of the convective cells and in the tracking of the aircraft, and in the post-evaluation of the properties of individual storms. Such analyses are possible now thanks to the TITAN systems that are installed on the radars. These are not readily feasible using the NEXRAD radars in their present configuration.

The radar-based evaluation of seeded storms, regardless of the radar system, is still a problem in the minds of some, because it is presumed that seeding somehow alters the cloud-base (i.e., base-scan) drop-size distribution and, therefore the radar-measured reflectivity and inferred rainfall. This would indeed be a problem compromising the use of radar for the evaluation of seeding experiments, if it were true, but the available evidence suggests that it is not for glaciogenic seeding, such as done in Texas. Cuning (1976) made measurements of raindrops from the bases of AgI-seeded and non-seeded storms in Florida and found that the intra-day and

inter-day natural drop-size variability was as large as that measured in rainfall from seeded storms.

It is recommended that these studies be continued in order to evaluate the accuracy of daily radar-rainfall estimates using the NEXRAD radar products. This is possible now, provided a suitable recording rain gauge standard can be found.

7. ACKNOWLEDGMENTS

The research of the first three authors was supported by the Texas Natural Resource Conservation Commission (TNRCC) under Agency Order No. 582-0-34048 and the first author had additional support from the Texas Water Development Board under Contract No. 2000-483-343. We thank the following individuals at the High Plains Underground Water Conservation District: Gerald Crenwelge the database engineer for his technical assistance, Dewayne Hovey for gauge plotting and mapping assistance and Keith Whitworth for drafting the isohyetal analyses. Finally, the High Plains Precipitation Enhancement Program acknowledges the participation and contributions from the following entities: South Plains Underground Water Conservation District, Sandy Land Underground Water Conservation District and the Llano Estacado Underground Water Conservation District.

8. REFERENCES

- Atlas, D., D. Rosenfeld, and D. B. Wolff, 1990: Climatologically tuned reflectivity-rain rate relations and their links to area time integrals. *Journal of Applied Meteorology*, 29, 1120-1139.

- Atlas, D., Editor, 1990: Radar in Meteorology, Boston, Amer. Meteor. Soc., 806pp.
- Bomar, G. A., W.L.Woodley and D. Bates (1999): The Texas weather modification program, objectives, approach and progress. *J. Wea. Mod.*, 31, 9-22.
- Cunning, J.B., Jr., 1976: Comparison of the Z-R relationship for seeded and non-seeded Florida cumuli. *J. Appl. Meteor.*, 15, 1121-1125.
- Dennis, A.S., A. Koscielski, D.E. Cain, J.H. Hirsch and P.L. Smith, Jr., 1975: Analysis of radar observations of a randomized cloud seeding experiment. *J. Appl. Meteor.*, 14, 897-908.
- Doneaud, A.A., S.I. Niscov, D.L. Priegnitz and P.L. Smith, 1984: The area-time integral as an indicator for convective rain volumes. *J. Climate Appl. Meteor.*, 23, 555-561.
- Rosenfeld, D., D. Atlas, and D. A. Short, 1990: The estimation of rainfall by area integrals. Part 2. The Height-Area Rain Threshold (HART) method. *Journal of Geophysical Research*, 95, 2161-2176.
- Rosenfeld, D. and W.L. Woodley, 1993: Effects of cloud seeding in west Texas: Additional results and new insights. *J. Appl. Meteor.*, 32, 1848-1866.
- Woodley, W.L., A.R. Olsen, A. Herndon, and V. Wiggert, 1975: Comparison and gage and radar methods of convective rain measurement. *J. Appl. Meteor.*, 14, 909-928.
- Woodley, W.L., J. Jordan, J. Simpson, R. Biondini, J.A. Flueck, and A. Barnston, 1982: Rainfall results of the Florida Area Cumulus Experiment. 1970-1976. *J. Appl. Meteor.*, 21, 139-164.
- Woodley, W.L., A. Barnston, J.A. Flueck, and R. Biondini, 1983: The Florida Area Cumulus Experiment's second phase (FACE-2). Part II: Replicated and confirmatory analyses. *J. Climate Appl. Meteor.*, 22, 1529-1540.
- Woodley, W.L., D. Rosenfeld, W. Sukarnjanaset, P. Sudhikoses, S. Ruangstittinaruparp and W. Khantiganan, 1999b: The Thailand cold-cloud seeding experiment: 2. Results of the statistical evaluation. Proc. of 7th WMO Conf. on Wea. Mod., 16-22 Feb. 1999, Chiang Mai, Thailand.

APPENDIX D

Glossary of Geologic and Hydrologic Terminology

This glossary is broad in scope to assist nonspecialists reviewing this report, but is not meant to cover all possible terms. Additional karst definitions and geologic terms can be found in the geologic dictionary of Jackson (1997).

Alluvium: Stream-deposited sediments, usually restricted to channels, floodplains, and alluvial fans.

Aquiclude: Rocks or sediments, such as shale or clay, which do not conduct water in significant quantities.

Aquifer: Rocks or sediments, such as cavernous limestone and unconsolidated sand, which store, conduct, and yield water in significant quantities for human use.

Aquitard: Rocks or sediments, such as cemented sandstone or marly limestone, that transmit water significantly more slowly than adjacent aquifers and that yield at low rates.

Artesian: Describes water that would rise above the top of an aquifer if intersected by a well; sometimes flows at the surface through natural openings such as fractures.

Base level: The level to which drainage gradients (surface and subsurface) are adjusted, usually a surface stream, relatively impermeable bedrock, or water table. Sea level is the ultimate base level.

Baseflow: The “normal” discharge of stream when unaffected by surface runoff; derived from groundwater flowing into the stream channel.

Beds: See strata.

Bedding plane: A plane that divides two distinct bedrock layers.

Cave: A naturally occurring, humanly enterable cavity in the earth, at least 5 m in length and/or depth, in which no dimension of the entrance exceeds the length or depth of the cavity (definition of the Texas Speleological Survey).

Chert: A microcrystalline silica rock, often found as nodules or small lens in limestone and dolomite; it is essentially the same as “flint.”

Colluvium: Loose, poorly sorted deposits of sediment moved down-slope by gravity and sheetwash; includes talus and cliff-fall deposits.

Conduit: A subsurface bedrock channel formed by groundwater solution to transmit groundwater; often synonymous with cave and passage, but generally refers to channels either too small for human entry, or of explorable size but inaccessible. When used to describe a type of cave, it refers to base level passages that were formed to transmit groundwater from the influent, upgradient end of the aquifer to the effluent, downgradient end.

Conduit flow: Groundwater movement along conduits; usually rapid and turbulent.

Cone of depression: A sunken or funnel-shaped area of the potentiometric surface; usually associated with groundwater withdrawal through wells.

Confined: Pertaining to aquifers with groundwater restricted to permeable strata that are situated between impermeable strata.

Cretaceous: A period of the geologic time scale that began 135 million years ago and ended 65 million years ago.

Discharge: The water exiting an aquifer, usually through springs or wells; also the amount of water flowing in a stream.

Drainage basin: A watershed; the area from which a stream, spring, or conduit derives its water.

Drainage divide: Location where water diverges into different streams or watersheds. On the surface they usually occur along ridges or elevated areas. In aquifers, they occur along highs in the potentiometric surface between groundwater basins.

En echelon: Typically refers to faults or other structures that occur in an overlapping but collectively linear arrangement, such as to form a fault zone.

Facies: The characteristic appearance or aspect of a rock unit; often subclassified or described based on stratigraphy, fossils, mineralogy, lithology, and other similar factors.

Fault: Fracture in bedrock along which one side has moved with respect to the other.

Floodplain: The flat surface that is adjacent and slightly higher in elevation to a stream channel, and which floods periodically when the stream overflows its banks.

Fracture: A break in bedrock that is not distinguished as to the type of break (usually a fault or joint).

Geomorphology: The branch of geology that studies the shape and origin of landforms.

Grade: The continuous descending profile of a stream; graded streams are stable and at equilibrium, allowing transport of sediments while providing relatively equal erosion and sedimentation. A graded profile generally has a steep slope in its upper reaches and a low slope in its lower reaches.

Head: The difference in water level elevations that creates the pressure for water movement down a gradient.

Headward: In the direction of greater elevation; typically refers to upstream or up a hydraulic gradient.

Homogeneous: Condition where an aquifer's hydraulic properties are the same in all locations.

Hydrogeology: The study of water movement through the earth, and the geologic factors that affect it.

Hydrograph: A graph illustrating changes in water level or discharge over time.

Hydrograph separation: The division of a hydrograph into component sections, usually to show the behavior of baseflow versus quickflow; often used in karst to identify conduit flow versus diffuse flow.

Hydrology: The study of water and its origin and movement in atmosphere, surface, and subsurface.

Impermeable: Does not allow the significant transmission of fluids.

Joint: Fracture in bedrock exhibiting little or no relative movement of the two sides.

Karst: A terrain characterized by landforms and subsurface features, such as sinkholes and caves, which are produced by solution of bedrock. Karst areas commonly have few surface streams; most water moves through cavities underground.

Karst feature: Generally, a geologic feature formed directly or indirectly by solution, including caves; often used to describe features that are not large enough to be considered caves, but have some probable relation to subsurface drainage or groundwater movement. These features typically include but are not limited to sinkholes, enlarged fractures, noncavernous springs and seeps, soil pipes, and epikarstic solution cavities.

Lithology: The description or physical characteristics of a rock.

Marl: Rock composed of a predominant mixture of clay and limestone.

Miocene: An epoch of the Tertiary Period of the geologic time scale that occurred between 5 and 23 million years ago.

Nodular: Composed of nodules (rounded mineral aggregates).

Normal fault: A fault where strata underlying the fault plane are higher in elevation than the same strata on the other side of the fault plane.

Playa lake: A shallow, nearly flat-floored ephemeral lake formed in semi-arid to arid climates; waterless most of the time due evaporation and groundwater recharge.

Perched groundwater: Relatively small body of groundwater at a level above the water table; downward flow is impeded within the area, usually by impermeable strata.

Permeable: Allows the significant transmission of fluids.

Permeability: Measure of the ability of rocks or sediments to transmit fluids.

Pleistocene: An epoch of the Quaternary Period of the geologic time scale that began 2 million years ago and ended about 10,000 years ago. Colloquially called the "Ice Age" due to its episodes of continental glaciation.

Porosity: Measure of the volume of pore space in rocks or sediments as a percentage of the total rock or sediment volume.

Potentiometric surface: A surface representing the level to which underground water confined in pores and conduits would rise if intersected by a borehole. See water table.

Quaternary: A period of the geologic time scale that began 2 million years ago and continues to the present.

Rating curve: A curve on a graph based on measurements and extrapolated data, which correlates stage height to stream discharge.

Reach: The length of a stream or stream segment; often used to denote similar physical characteristics.

Recharge: Natural or artificially induced flow of surface water to an aquifer.

Seep: A spring that discharges a relatively minute amount of groundwater to the surface at a relatively slow rate; typically a "trickle."

Sheetwash: Surface water runoff that is not confined to channels but moves across broad, relatively smooth surfaces as thin sheets of water.

Sink: See sinkhole.

Sinkhole: A natural indentation in the earth's surface related to solutional processes, including features formed by concave solution of the bedrock, and/or by collapse or subsidence of bedrock or soil into underlying solutionally formed cavities.

Sinking stream: A stream that losses all or part of its flow into aquifer.

Slickensides: Grooves along fault planes formed by the movement of one rock surface against the other; the groves record the direction of relative movement.

Soil horizons: Layers of soil, each of certain characteristics. The A and B horizons are nearest the surface, have the greatest amount of plant activity, are composed of decomposed organic material and inorganic sediment, and correlate to the cutaneous zone; the C horizon is the deepest, has

minimal plant activity, is composed predominantly of weathered bedrock, and correlates to the subcutaneous zone.

Solution: The process of dissolving; dissolution.

sp.: Taxonomic abbreviation for “species;” when following a genus name, it indicates lack of identification to species level. Plural is spp.

?species: Taxonomic abbreviation for when genus identification is certain, but species identification is uncertain.

Specific capacity: The productivity of a well, expressed as the rate of discharge divided by the drawdown of the water level.

Spring: Discrete point or opening from which groundwater flows to the surface; strictly speaking, a return to the surface of water that had gone underground.

Stage: The water level elevation or height measured in a stream or a well.

Storativity: The volume of water released from or taken into an aquifer for each unit of aquifer surface area per unit of change in head; usually refers to storage within confined aquifers. See specific yield.

Strata: Layers of sedimentary rocks; usually visually distinguishable. Often called beds. The plural of stratum.

Stratigraphic: Pertaining to the characteristics of a unit of rock or sediment.

Stratigraphy: Pertaining to or the study of rock and sediment strata, their composition and sequence of deposition.

Structure: The study of and pertaining to the attitude and deformation of rock masses. Attitude is commonly measured by strike and dip; deformational features commonly include folds, joints, and faults.

Unconfined: Pertaining to aquifers having no significant impermeable strata between the water table and the land surface.

Water table: The boundary of the phreatic and vadose zones. A potentiometric surface but the term is used only in unconfined aquifers.

APPENDIX E

Conversions: International System of Units to English Units

MULTIPLY	BY	TO GET
<i>Length</i>		
centimeters (cm)	0.3937	inches (in)
meters (m)	3.281	feet (ft)
kilometers (km)	0.621	miles (mi)
<i>Area</i>		
square meters (m ²)	10.76	square feet (ft ²)
square kilometers (km ²)	0.3861	square miles (mi ²)
square kilometers (km ²)	247.1	acres (ac)
<i>Volume</i>		
liters (L)	0.264	gallons (gal)
cubic meters (m ³)	264.17	gallons (gal)
cubic meters (m ³)	0.00081	acre-feet (a-f)
<i>Flow</i>		
liters per second (L/s)	0.0353	cubic feet per second (cfs)
liters per second (L/s)	15.85	gallons per minute (gpm)
cubic meters per second (m ³ /s)	35.31	cubic feet per second (cfs)
cubic meters per second (m ³ /s)	1,585	gallons per minute (gpm)
cubic meters per second (m ³ /s)	70.05	acre-feet per day (a-f/d)
<i>Temperature</i>		
degrees Celsius	multiply by 1.8 then add 32	degrees Fahrenheit

Appendix F

Determinations of Mean Aquifer Recharge

The manner of determining the mean annual recharge for the aquifer segments, as presented in Table 24, is given in this appendix. A brief overview of each aquifer and its segments is included.

Alluvium and Bolson Aquifers

This group of aquifers is comprised of small to large areas of water-bearing alluvium throughout west and northwest Texas and along the Brazos River valley. Several of the aquifers have little detailed published information on their hydrogeologic characteristics. This study only considers the Hueco-Mesilla Bolson Aquifer, located along the Rio Grande valley in El Paso and Hudspeth counties. Since the Hueco portion of the aquifer is far larger in Texas than the Mesilla portion, only the Hueco portion is described and used to estimate mean recharge for the aquifer.

The Hueco-Mesilla Bolson Aquifer is comprised of unconsolidated sediments, primarily silts and clays that range in size up to gravels. The deposits include minor amounts of caliche and volcanic ash and reach a maximum thickness of 2,728 m (Gustavson, 1990). The Texas portion of the aquifer extends from the New Mexico border just west of El Paso 135 km southeast along the Rio Grande with a mean width of 15 km. The aquifer extends northward well into New Mexico as part of the Tularosa Bolson.

Meyer (1976) and Ashworth (1990) reported an average annual recharge rate of 6,000 acre-feet (7.4 million m³) for the Hueco Bolson from precipitation. No published source was found to provide the size of the aquifer's recharge zone, which is approximately calculated in this report from published maps as 1,745 km². Mean annual precipitation for this area, based on data from Larkin and Bomar (1983) is about 287,460 acre-feet/year (354.6 million m³/year). Based on these estimates, 2.1% of mean annual precipitation recharges the aquifer. This figure is used in Table 4.

Studies of the aquifer show a capacity for greater recharge. Experiments and calculations for artificial recharge of the aquifer suggest possible rates from about 19,000 m³/day (Sundstrom and Hood, 1952), which is slightly less than the mean annual recharge at 5,617 acre-feet (6.94 million m³), to 38,000 m³/day (Meyer, 1976), nearly twice the mean annual recharge at 11,235 acre-feet (13.87 million m³). The latter figure is probably far more accurate since it is based on more data and a longer period of record. It suggests that the recharge capacity of the aquifer is not met by current precipitation, and the aquifer should be able to recharge at higher rates if the rainfall becomes available.

Carrizo-Wilcox Aquifer

The recharge zone for the Carrizo-Wilcox Aquifer extends as a narrow belt, averaging 6 km wide, from the Rio Grande in northwest Webb County gradually widening to a mean width of 16 km after 475 km in Texas' northeast corner in Bowie County. Major rivers are used to divide this portion of the aquifer into six narrow segments for this report. A seventh, eastern

segment of the aquifer extends south from Marion County 155 km to northern Sabine County, and as far as 80 km west from the east Texas border. The aquifer is comprised of the Carrizo Sand Formation, a course to fine-grain sandstone that ranges from 45-365 m thick, and the Wilcox Formation, a sequence of interbedded sand, silt, clay, with some lignite, shale, and gypsum, that ranges from 0-853 m thick.

Rio Grande to Nueces River Segment and Nueces River to Guadalupe River Segment

These combined segments of the Carrizo-Wilcox Aquifer are known as the Winter Garden Area and are the primary groundwater supply for the agriculture industry south and southwest of San Antonio. Klemt, Duffin, and Elder's (1976) conducted the first significant study of the Winter Garden Area, which was in part based on the substantial data subsequently published by Marquardt and Rodriguez (1977). Muller and Price (1979) identified total recharge for these segments of the aquifer as 174,400 acre-feet/year (215.1 million m³/year).

Getzendaner (1953) injected water via a well into the Carrizo Sand near Crystal City near the recharge zone of the Rio Grande to Nueces River Segment of the aquifer. After nearly 5 hours, the well continued to accept the water at a rate of about 4,900 m³/day. There is no additional record of the well's response to the injection. Barnes (1956) estimated that water could be injected into the Carrizo Sand in Wilson County at a rate of 112,000 acre-feet/year (138.3 million m³/year) which suggests that the recharge rate based on Getzendaner's (1953) injection test was not anomalous. Klemt, Duffin, and Elder (1976) determined by computer modeling that 330,000 acre-feet/year (407.4 million m³/year) could be withdrawn from the Winter Garden area of the Carrizo-Wilcox Aquifer until 2020 without lowering the water table more than 122 m below the land surface. This discharge rate and the injection studies, along with published aquifer permeability and transmissivity values, represent the aquifer's ability to efficiently transmit groundwater and suggest conditions favorable to accepting greater volumes of recharge during periods of higher rainfall.

Hamblin (1988) subdivided the Winter Garden Area of the Carrizo-Wilcox Aquifer into three zones and assessed their total average recharge at 100,000 acre-feet/year (123.4 million m³/year). The Southwestern Zone correlates almost exactly to this study's Rio Grande to Nueces River Segment, and the combined Central Zone and Northeastern Zone are essentially equal to the Nueces to Guadalupe River Segment. Based on Hamblin's findings, the Rio Grande to Nueces River Segment has a mean recharge rate of 16,000 acre-feet/year (19.7 million m³/year) and the Nueces River to Guadalupe River Segment has a mean recharge rate of 84,000 acre-feet/year (103.6 million m³/year). Hamblin's total recharge is less than that calculated by Muller and Price (1979) because it only considers the outcrops of the Carrizo Sand and the upper Wilcox Formation. However, that area and Hamblin's recharge figures are used in this report because they more are current and presumably more accurate, but primarily because they correlate almost precisely to this report's aquifer segments and reduce potential interpolative error.

No published source was found to provide the size of the aquifer's recharge zone, which is approximately calculated in this report from Hamblin's (1988) maps as 681 km² for the Rio Grande to Nueces River Segment and 1,965 km² for the Nueces River to Guadalupe River Segment. The mean annual volume of precipitation for the respective segments, based on data

from Larkin and Bomar (1983) is about 301,500 acre-feet/year (371.9 million m³/year) and 1.05 million acre-feet/year (1.30 billion m³/year). Based on these estimates and Hamblin's (1988) recharge rates, 5.3% of mean annual precipitation recharges the Rio Grande to Nueces River Segment of the aquifer and 8% of mean annual precipitation recharges the aquifer's Nueces River to Guadalupe River Segment. These percentages are used in Table 4.

Guadalupe River to Colorado River Segment, Colorado River to Brazos River Segment, and Brazos River to Trinity River Segment

Muller and Price (1979) estimated that only about 10% of precipitation in this portion of the Carrizo-Wilcox Aquifer would enter as recharge. Further work by Thorkildsen and Price (1991) found that the aquifer between the Guadalupe River and the Trinity River "is nearly full and receives very little recharge." They estimated by computer modeling that only slightly more than 2.5 cm, or 2.69%, of mean annual precipitation entered the aquifer as recharge. This suggests that HSIR would only negligibly increase recharge since most current precipitation is lost to ET or runoff that can't enter the aquifer. Further modeling discussed by Thorkildsen and Price (1991) indicated that recharge could be increased to 5% of mean annual precipitation from increased pumping of the aquifer that would lower the water table, but they did not specify the amount of pumping needed. Although no source is cited for the modeling results, it is likely based on the work of Thorkildsen, Quincy, and Preston (1989), who ran pumping scenarios of up to 208,000 acre-feet (256.8 million m³) which exceed the 100,000 acre-feet (123.5 million m³) pumping scenario examined by Dutton (1999) for recent proposed withdrawals from the aquifer. However, Thorkildsen, Quincy, and Preston (1989) focused on the portion of the aquifer within about 37 km of the Colorado River, and no evidence is given to suggest that it is actually representative of the entire Guadalupe to Trinity River area. Dutton (1999) modeled the Colorado River to Brazos River Segment but did not evaluate the impacts of pumping on recharge.

In contrast to Thorkildsen and Price (1991), Ryder (1988) and Ryder and Ardis (1991) estimated recharge rates 2-4 times higher. The lower end of this estimate is approximately the same rate as the 5% high end of Thorkildsen and Price's (1991) estimate of recharge following increased pumping, and therefore 5% of rainfall is used in place of a recharge volume in Table 4 as the approximate recharge rate for the Guadalupe to Colorado, Colorado to Brazos, and Brazos to Trinity segments of the Carrizo-Wilcox Aquifer.

Trinity River to Sulfur River Segment and Eastern Segment

Fogg and Kreitler (1982) provided hydrogeologic data for the Trinity River to Sulfur River Segment and Eastern Segment of the Carrizo-Wilcox Aquifer. They did not provide mean values for these specific segments but listed means for counties throughout the region, and they did not provide aquifer recharge data. Muller and Price (1979) estimated that 213,000 acre-feet (262.7 million m³) of water recharges the aquifer in this region but also pointed out that "less than 5 percent" of annual rainfall becomes recharge. The low topography of the region, the aquifer-fed streams, and the frequent flooding of the streams demonstrate that the water table is close to the land surface. Like the aquifer segments between the Guadalupe and Trinity rivers, only little additional recharge can be absorbed. For lack of additional information it is probably

best to calculate HSIR enhanced recharge based on 4% of rainfall in place of a recharge volume in Table 4 for the Trinity to Sulfur River and Eastern segments of the Carrizo-Wilcox Aquifer.

Edwards (Balcones Fault Zone) Aquifer

The Edwards (Balcones Fault Zone) Aquifer is a complex hydrologic system within the Edwards Limestone in the Balcones Fault Zone. It is divided into four segments: San Antonio, Barton Springs, Northern Balcones, and Washita Prairie (Yelderman, 1987). A drainage divide, an incised valley, and a gap of Edwards Limestone outcrop within the fault zone respectively separate the segments. Except for the Washita Prairie Segment, which is not as major a water supply as the others and is not evaluated in this report, the Edwards segments are divided into four zones: drainage or contributing zone, recharge zone, artesian or confined zone, and saline zone. The drainage zone is the upgradient non-Edwards Limestone area where streamflow reaches or crosses the recharge zone, the exposure of Edwards Limestone within the fault zone where water enters the aquifer. The artesian zone is that area where the Edwards Limestone is down-faulted into the subsurface, and its groundwater is confined between upper and lower less permeable formations. The aquifer's largest springs occur where groundwater rises up fractures to discharge in stream valleys that intersect the potentiometric surface. The "bad water line" is the downgradient boundary of the artesian zone with the saline zone, where total dissolved solids in the groundwater exceed 1,000 mg/l.

The Edwards is the most productive aquifer in Texas and its most complex. In the San Antonio area it is divided into eight hydrostratigraphic units with varying hydrologic behaviors that grade with distance into other units with different hydrologic characteristics. These units are jumbled and juxtaposed across the recharge zone by Balcones faulting and interlaced by flowpaths varying in permeability by many orders of magnitude due to karstic dissolution. The abundance of caves, sinkholes, solutionally enlarged fractures, and other karst features, make extremely high rates of recharge possible (Maclay, 1995). The high percentages of recharge in Table 4 that are calculated below are in large part the result these highly permeable karst features. Although much remains to be learned about the Edwards, it is probably the most intensively studied aquifer in Texas since it is the sole water supply for over 1.5 million people.

San Antonio Segment

The most studied portion of the Edwards Aquifer is the San Antonio Segment. Its recharge zone extends from near the town of Brackettville, 160 km east to San Antonio, then northeast about 80 km to near the town of Kyle, and varies in width from 1-24 km. Permeability in the aquifer has been measured as high as 1,300 m/day (Maclay and Small, 1986). The mean recharge into the aquifer for the 1934-1999 period of record was 680,000 acre-feet/year (839.5 million m³/year), although mean recharge from 1990-1999 was 970,900 acre-feet/year (1.199 billion m³/year) (Esquilin, 2000). The construction of several recharge dams has contributed to increasing recharge into the aquifer since the 1970s. However, an examination of the recharge data for those structures suggests that the significant recharge since 1990 is mainly due to three years of high rainfall, including the record recharge year. Therefore, the mean recharge for the entire period of record, while possibly a little conservative, is used for this report.

The recharge zone of the San Antonio Segment covers about 3,900 km² (Edwards Underground Water District, 1992). The mean annual volume of precipitation over the aquifer, based on data from Larkin and Bomar (1983), is about 2.17 million acre-feet/year (2.67 billion m³/year). Groshen (1996) found that 33-87% of recharge occurs from precipitation within the recharge zone. Previous studies suggested 60% (Maclay and Land, 1988) to 85% (Puente, 1978) of recharge was from precipitation in the contributing zone that flowed onto the recharge zone. For this report, an approximate mean of 50% is applied to the aquifer recharge rates to identify the portion from precipitation over the recharge zone. Based on that rate and the other estimates above, 15.7% of mean annual precipitation recharges the San Antonio Segment of the aquifer. This percentage is used in Table 4.

Barton Springs Segment

The Barton Springs Segment of the Edwards Aquifer is approximately one twelfth the size of the San Antonio Segment, extending southwest from the Colorado River in Austin for 36 km to near the town of Kyle. However, the two aquifer segments share many hydrogeologic characteristics. Hauwert, Johns, and Aley (1998) reported conduit permeabilities through the aquifer in excess of 6.4 km/day, as determined by dye tracing from caves to springs. Even higher rates have since been demonstrated by additional tracer studies (Nico Hauwert, personal communication, 2000). Slade, Dorsey, and Stewart (1986), among other authors, reported a mean recharge rate for the aquifer of 43,803 acre-feet/year (54.1 million m³/year) based on only a 42-month period of record from July 1979 through December 1982. That period probably had below normal recharge, based on precipitation records for the San Antonio area (Esquilin, 2000). Barrett and Charbeneau (1996) confirmed this hypothesis by examining data from 1979 through 1995 and finding that mean recharge rates for that period were 57,400 acre-feet/year (70.9 million m³/year).

The recharge zone of the Barton Springs Segment covers about 401 km² (Small, Hanson, and Hauwert, 1996). The mean annual volume of precipitation over the aquifer, based on data from Larkin and Bomar (1983), is about 264,200 acre-feet/year (325.9 million m³/year). Woodruff (1994) estimated that 6% of precipitation becomes recharge, but he included the precipitation on the contributing zone in his equations. Based on the aquifer's mean recharge rate and the estimated volume of precipitation over the recharge zone, 21.7% of mean annual precipitation recharges the Barton Segment of the aquifer. This percentage is used in Table 4.

Northern Segment

The Northern Segment of the Edwards Aquifer extends northeast for 76 km from the Colorado River in Austin nearly to the Lampasas River in Bell County. The northwest margin of the aquifer's recharge zone is irregular in shape, but on average, the recharge zone has a width of about 15 km. Senger, Collins, and Kreitler (1990) provided the most detailed report on the aquifer, but despite several hydrogeologic investigations, an aquifer-wide recharge rate has apparently not yet been determined. Muller and Price's (1979) evaluation of groundwater availability in this segment of the aquifer only considered discharge from the Salado Springs, which is inadequate for this study. Harringer (1985), Snyder (1985), and Baker et al. (1986) presented discharge data for the aquifer segment's springs which totaled a combined mean discharge of 49,958 acre-feet/year (61.7 million m³/year). Harringer (1985) also provided

histograms of total reported municipal and industrial pumpage for the North Segment of the aquifer. The mean pumpage for 1977, which is roughly the central period during which most springflows were measured, totaled 5,939 acre-feet/year (7.3 million m³/year).

Groundwater budgets require that long-term mean discharge equal long-term mean recharge. Therefore, the total recharge of the Northern Segment of the Edwards Aquifer must at least equal the measured discharge from the combined springs plus discharge from pumping, since there is no evidence that the pumping is exceeding recharge rates by causing significant declines in the water table. However, this total of 55,897 acre-feet/year (69.0 million m³/year) is probably substantially less than the minimum rate because discharge from numerous unreported springs, rural pumping, and leakage to other aquifers have not been counted.

The recharge zone of the Northern Segment of the aquifer is very similar to that of the San Antonio and Barton Springs segments. Little soil is present over its highly fractured and karstified surface. Recharge rates are probably also similar. By referring to Table 4 and dividing the mean recharge rates of the other Edwards Aquifer segments by the sizes of their recharge zones, the average square kilometer of the San Antonio Segment's recharge zone has a mean recharge rate of 109.9 acre-feet/year (135,622 m³/year), and the average square kilometer of the Barton Springs Segment's recharge zone has a similar mean recharge rate of 115.3 acre-feet/year (142,369 m³/year). The mean recharge rate per square kilometer for the two aquifer segments is 112.6 acre-feet/year (139,012 m³/year). Since the Northern Segment of the aquifer is similar in many respects to the other segments, it is reasonable to assume that it has a comparable recharge rate that can be approximated by the mean rate of the other segments. Therefore, multiplying the 112.6 acre-feet/year/km² (139,012 m³/year/km²) rate by the Northern Segment's approximate recharge zone area of 1,120 km² yields a mean recharge rate 126,112 acre-feet/year (155.7 million m³/year). While this number is notably greater than the measured discharge, it is somewhat supported by the measured discharge by being within a reasonable range after considering discharge and other unaccounted factors.

The recharge zone of the Northern Segment covers about 990 km² based on maps provided by Senger, Collins, and Kreitler (1990). The mean annual volume of precipitation over the aquifer, based on data from Larkin and Bomar (1983), is about 652,350 acre-feet/year (804.7 million m³/year). Woodruff (1994) estimated that 6% of precipitation becomes recharge, but included the precipitation on the contributing zone in his equations. Based on the aquifer's mean recharge rate and the estimated volume of precipitation only over the recharge zone, 19.3% of mean annual precipitation recharges the Northern Segment of the aquifer. This percentage is used in Table 4.

Edwards-Trinity Aquifer

The Edwards-Trinity Aquifer occurs throughout the Edwards Plateau. The aquifer extends from near the east side of Balcones Fault Zone west for 600 km and about 240 km north from the south side of the curved fault zone. It is an unconfined aquifer with recharge occurring in permeable fractures, sinkholes, caves, and strata, primarily in the Edwards Limestone. The high recharge rates possible with these features indicate the aquifer could readily accept more recharge if additional rainfall made it available.

Discharge from the aquifer occurs via gravity-drained springs in valleys. These springs provide the baseflow of several central Texas rivers and are important in recharging neighboring aquifers. Springs are usually located at contacts with underlying poorly permeable strata. Occasionally these strata are within the Edwards Limestone, but springs develop most commonly at the Edwards' basal contact with the upper member of the Glen Rose Formation. The upper Glen Rose is part of the Trinity Group but is generally less permeable than some of the underlying units in the Trinity that carry and yield more water to wells.

Regional groundwater flow for the aquifer is south and southeast, heading both downdip and toward the plateau margin. Throughout much of the plateau the water table has an elevation of 550-700 m a.s.l. and is usually between 80-100 m below the surface. The vertical distance from the water table down to the upper Glen Rose aquiclude averages 30 m and thins near the fringes of the plateau. Groundwater yield to wells varies from low to high due to the limestone's anisotropic permeability. Barker and Ardis (1996) provided the most complete and recent overview of the aquifer's hydrogeology.

Large areas of the Edwards-Trinity Aquifer are sparsely populated and have received relatively little study. Figure 3 shows the aquifer divided into three segments. Combined, the segments do not cover the entire aquifer region. Some aquifer areas have been excluded from these segments due to poorly defined hydrologic characteristics or locally distinct characteristics that are not representative of the general aquifer area.

Central Segment

For the purposes of this study, the Central Segment of the Edwards-Trinity Aquifer covers most of Crockett, Schleicher, and Sutton counties, and northern Edwards and Val Verde counties. While the aquifer actually covers a considerable area to the east, it is excluded because it receives greater precipitation there and is highly dissected by streams, forming multiple small, hydrologically distinct aquifer subsections. To the south, this aquifer segment grades into the Edwards (Balcones Fault Zone) Aquifer. The area to the north has scant hydrological data.

Walker (1979) provided an approximate recharge rate for the Edwards-Trinity Aquifer of 625,000 acre-feet/year (771.6 million m³/year) for the 59,600-km² area east of the Pecos River. More recent studies of the aquifer (e.g. Barker and Ardis, 1996) do not present revised recharge estimates for the aquifer, and the discharge, transmissivity, and permeability data they present do not appear to refute Walker's estimate. The mean annual volume of precipitation over the aquifer, based on data from Larkin and Bomar (1983), is about 29.5 million acre-feet/year (36.3 billion m³/year). Based on the Walker's (1979) mean recharge rate for entire Edwards-Trinity Aquifer and the estimated volume of precipitation over that area, 2.1% of mean annual precipitation recharges the Central Segment of the aquifer. This percentage is used in Table 4.

Stockton Plateau Segment and Trans-Pecos Segment

The Stockton Plateau and Trans-Pecos segments are the extension of the Edwards Plateau west of the Pecos River. Hydrogeologically, the Stockton Plateau is similar to the Central Segment of the aquifer on the east side of the river, except that the climate is drier, and poorly permeable units that restrict or prevent recharge cover much of its southern end. The Stockton

Plateau is delimited by Terrell County, eastern Brewster County, and southern Pecos County. The Trans-Pecos Segment extends north and northwest of the Stockton Plateau. It includes central and western Pecos County, and parts of Brewster, Culberson, and Jeff Davis counties. Hydrogeologically, it is similar to the Stockton Plateau, except that the limestone thins, some limestone units become marly, and a larger portion of the Trans-Pecos recharges water that flows onto the aquifer from mountains to the west and south.

Muller and Price (1979) estimated recharge for the entire Edwards-Trinity Aquifer as 776,000 acre-feet/year (957.2 million m³/year). Their work was contemporaneous with Walker's (1979), and it is clear from their report that they were aware of Walker's work. It is probably safe to assume that they used Walker's estimate of 625,000 acre-feet/year (771.6 million m³/year) for the portion of the aquifer east of the Pecos River, which leaves 149,000 acre-feet/year (183.8 million m³/year) of recharge for the Stockton Plateau and Trans-Pecos segments of the aquifer. Rees and Buckner (1980) included both the Stockton Plateau and Trans-Pecos segments in their assessment of the Edwards-Trinity Aquifer west of the Pecos River. Indirectly, they provided the mean recharge rates for the aquifer by defining sustainable annual discharge from the aquifer as 150,000 to 190,000 acre-feet/year (185 to 234 million m³/year), since sustainable discharge must be balanced by an equal volume of recharge. Their slightly to moderately higher recharge estimate is probably more accurate than that of Muller and Price (1979) since Rees and Buckner's (1980) work was focused on those aquifer segments. For this report, the mean recharge rate of 170,000 acre-feet/year (210.5 million m³/year) is used for both aquifer segments.

Since the Trans-Pecos Segment receives slightly greater precipitation due the proximity of nearby mountains, as an approximation for this report, the 190,000 acre-feet/year (234 million m³/year) recharge rate is used for that area, and the 150,000 acre-feet/year (185 million m³/year) recharge rate is used for the Stockton Plateau. These aquifer segments, as defined for this report, respectively comprise 9.7 and 22.6% of the 24,350-km² area defined by Rees and Buckner (1980). Multiplying their mean recharge rates by the percentages yields the approximate volume of mean recharge for each aquifer segment, 18,430 acre-feet/year (22.8 million m³/year) and 33,900 acre-feet/year (41.9 million m³/year), which are used in Table 4.

The recharge zone of the Stockton Plateau and Trans-Pecos segment covers 24,350-km² (Rees and Buckner, 1980). The mean annual volume of precipitation over the aquifer, based on data from Larkin and Bomar (1983), is about 6.77 million acre-feet/year (8.35 billion m³/year). Based on the aquifer's mean recharge rate and the estimated volume of precipitation only over the recharge zone, 2.5% of mean annual precipitation recharges the Stockton Plateau and Trans-Pecos segments of the aquifer. This percentage is used in Table 4.

Gulf Coast Aquifer

The Gulf Coast Aquifer follows the Texas coastal bend, arcing north and then eastward from Mexico to Louisiana. The aquifer extends inland from the coast for about 160 km. Several formations comprise the aquifer. Major water-bearing units include the Oakville Sandstone, Goliad Sand, Willis Sand, and Lissie Formation which are Miocene to Pleistocene age sediments of alternating clays, silts, sands, and gravels. The units pinch out landward and thicken to several kilometers as they dip down toward the coast. Their dip makes the aquifer's recharge zone a

series of bands parallel to the coast where the units crop out at the surface. Baker (1979) described the aquifer's hydrostratigraphy.

Salinity of the groundwater increases toward the coast and to the southwest. Causes of high salinity include insufficient fresh groundwater flow to flush out marine water trapped in the sediments during their deposition, groundwater flow around salt domes, mixing with sea water that naturally occurs in near-coastal sections of the aquifer, and sea water encroachment due to groundwater pumping. Groundwater pumping has also resulted in substantial land subsidence, notably in the Houston area. Reports that examine the hydrogeology of that phenomenon include work by Gabrysch (1984) and Sharp et al. (1991). The aquifer becomes sandier and more permeable to the northeast, which along with greater rainfall, results in its lower salinity in that area. Much of the aquifer's southern half is not potable because it exceeds drinking water standards for sulfate and/or chloride (Groundwater Protection Unit, 1989). Uranium deposits and their mining in some parts of the aquifer, notably the Oakville Sandstone, have the potential to adversely impact groundwater quality. Hydrogeologic studies of that portion of the aquifer include work by Henry et al. (1982) and Smith, Galloway, and Henry (1982).

Although the Gulf Coast Aquifer is classified as a single unit, it is comprised of several, discrete smaller aquifers. Permeability, transmissivity, and storage vary according to the physical properties of each aquifer. Groundwater flow is generally toward the coast, although some variation occurs at the local scale. As the aquifer units dip coastward, they become confined between poorly permeable units, and some produce artesian wells when drilled. Most research to date has focused on groundwater in various counties or on the individual smaller aquifers. For example, Popkin (1971) and Loskot, Sandeen, and Follett (1982) studied the groundwater in Colorado, Lavaca, Montgomery, and Wharton counties, while Baker (1986) examined the Jasper Aquifer and Carr et al. (1985) modeled the Chicot and Evangeline aquifers.

Recharge into the Gulf Coast Aquifer has been poorly defined. Gabrysch (1977) determined that the effective recharge of the Gulf Coast Aquifer in the Houston area was 392,200 acre-feet/year (483.8 million m³/year). Modeling by Muller and Price (1979) resulted in a much higher estimated effective recharge for the area of 1.23 billion acre-feet/year (1.52 billion m³/year), which comprises about 30% of the area of the Brazos River to Sabine River Segment of the aquifer. Loskot, Sandeen, and Follett (1982) determined that 78,000 acre-feet/year (96.2 million m³/year) of recharge enters the Chicot Aquifer, and 38,000 acre-feet/year (46.9 million m³/year) of recharge enters the Evangeline Aquifer in Colorado, Lavaca, and Wharton counties in the Nueces River to Brazos River Segment of the aquifer. No recharge data could be found for the Rio Grande to Nueces River Segment of the aquifer. Baker (1986) determined that about 2% of rainfall recharges the Jasper Aquifer in the aquifer's Brazos River to Sabine River Segment. Given the paucity of recharge data, the variability in the probable recharge rates of individual aquifers within the Gulf Coast Aquifer system, and the high variations in the calculated recharge data available, Baker's (1986) 2% of rainfall estimate will be used in Table 4 to calculate the aquifer's recharge in this study. It is consistent with the low topography, shallow water table, and low to moderate permeabilities of the region, and automatically compensates for the lower precipitation that occurs in the southern portion of the aquifer where no recharge estimates could be found.

Ogallala Aquifer

The Ogallala Aquifer underlies most of the northwest Texas panhandle, extending from the towns of Midland and Odessa north across the mid-continental High Plains as far as Nebraska, then continuing northward into Canada within lithologic units equivalent to the Ogallala Formation (Meinzer, 1923). Only the portion of the aquifer within Texas is considered in this report.

The Ogallala Formation is a Miocene to Pliocene age suite of alluvial fan deposits. It contains coarse gravels to sands, silts, and clays. The unit ranges in thickness from zero along its eroded margins to a maximum of 244 m in the Palo Duro area of Randall County. The Central and Southern segments of the aquifer, as defined for this study, occur south of the Canadian River which cuts through much of the Ogallala Formation. The Northwest and Northeast segments of the aquifer occur north of the river. The Ogallala Formation south of the river has a mean thickness of 60 m, while north of the river it averages about 140 m thick. Seni (1980) described the stratigraphy and depositional history of the formation.

Groundwater in the aquifer is unconfined and generally flows from west to east, discharging at springs or through wells. Excessive pumping of the aquifer has resulted in severe water table declines, and several studies have focused on quantifying the decline and modeling recovery scenarios. Permeability is highest in the central portion of the aquifer but does not necessarily correlate to coarser grained materials. The Ogallala Formation is underlain by various Cretaceous, Triassic, and Permian formations. The Cretaceous units tend to be the least permeable, but some leakage and hydrologic continuity exists with all of the deeper strata. Water in the northern section of the aquifer is of higher quality, while south of a line between the cities of Lubbock and Muleshoe, the water is often high in sulfates and chlorides. Knowles, Nordstrom, and Klemt (1984) conducted a detailed study of the aquifer and published a substantial database of well and hydrologic data. Nativ (1988) examined the hydrogeology and geochemistry of the aquifer and Hopkins (1993) evaluated its water quality.

Mullican, Johns, and Fryar (1997) provided a useful summary of numerous Ogallala Aquifer recharge studies, including a list of recharge rates published as early as 1901 that range from 0.24 to 214 mm/year. The wide range in values results from measurements of both focused recharge rates in playa lakes and diffused regional recharge. Most recharge into the Ogallala occurs through playa lakes with a smaller, unspecified percentage occurring directly through the Ogallala Formation in non-playa locations; relatively little recharge occurs along streams. Aquifer modeling by Mullican, Johns, and Fryar (1997) found good correlations between models and known water levels when applying a playa-focused recharge rate of 214 mm/year, which covers only 2.74% of their study area, and rate of 9 mm/year for the recharge across the general outcrop. Proportionally combining these rates yields an average recharge rate of 14.6 mm/year, which when multiplied by the 91,000-km² aquifer recharge area yields a rate of 1,077,100 acre-feet/year (1.33 billion m³/year).

The recharge rate based on Mullican, Johns, and Fryar's (1997) results is significantly greater than the 298,200 acre-feet/year (367.8 million m³/year) rate determined by Muller and Price (1979) and the 371,910 acre-feet/year (458.8 million m³/year) rate determined by Knowles, Nordstrom, and Klemt (1984). Since Mullican, Johns, and Fryar only modeled a portion of the

aquifer, their results may not be applicable throughout the entire aquifer. Wood and Sanford (1995) estimated an aquifer-wide mean recharge rate of 11 mm/year or 811,500 acre-feet/year (1.00 billion m³/year). While this value is still substantially higher than earlier estimates, it is based on more detailed hydrologic and geochemical data and is conservative compared to the more recent study by Mullican, Johns, and Fryar (1997). It is therefore adopted as the mean aquifer recharge rate for this investigation.

There is insufficient information to hydrogeologically determine recharge rates for each of the four segments of the Ogallala Aquifer defined for this study. They are established based on the division of the aquifer by the Canadian River, areas of similar rainfall intensity, and areas of generally similar hydrogeologic characteristics. The recharge percentage for the segments in Table 4 are based on Wood and Sanford's (1995) 11 mm/year recharge rate divided by the mean annual precipitation in those areas as estimated from Larkin and Bomar (1983).

Trinity Aquifer

The Trinity Aquifer is recognized as a separate hydrologic unit from the Edwards-Trinity Aquifer where the Edwards Limestone has been removed by erosion along the margin of the Edwards Plateau. The aquifer is comprised of several units that include a variety of limestones, marls, sandstones, and clays. The major units exposed in outcrop are the Antlers, Glen Rose, Paluxy, and Travis Peak Formations. The Trinity is largely unconfined and generally discharges eastward via springs into valleys; downdip it becomes increasingly confined, artesian, and higher in dissolved solids. The units range in thickness from 30 m in the outcrop area to 366 m in the confined downdip areas. The recharge zone for the aquifer is an irregularly-shaped band that extends from Bandera County for 520 km to the Oklahoma border, while ranging in width from 1 to 210 km. Muller and Price (1979) provide an overview of the aquifer, as does the Ground Water Protection Unit (1989) but with an emphasis on water quality.

Muller and Price estimated recharge into the Trinity Aquifer at a rate of 95,100 acre-feet/year (117.3 million m³/year), based on a mean rate of 1.5% of precipitation becoming recharge. This percentage was determined in the northern portion of the aquifer and is not generally applicable. Below are recharge rates for the four aquifer segments defined for this study.

Lower Glen Rose Segment

This southernmost segment of the Trinity Aquifer has been overlooked by several investigations. For example, the Ground Water Protection Unit (1989) does not show that the Trinity Aquifer outcrops in this segment within Blanco, Comal, and Kendall counties. Also, numerous studies refer to the aquifer as poor to moderately permeable, ignoring its highly developed karst permeability, including the longest underground stream in Texas with over 32 km surveyed (Veni, 2000).

The lower member of the Glen Rose Formation is a distinct hydrostratigraphic unit within the Middle Trinity section of the Trinity Aquifer group. This aquifer segment is largely unconfined but has down-faulted confined portions within the Balcones Fault Zone where it loses water to the Edwards (Balcones Fault Zone) Aquifer (Veni, 1995). Ashworth (1983) assessed the regional

hydrogeology, including the upper member of the Glen Rose and water-bearing Trinity units that underlay the Glen Rose, and Veni (1997) conducted a detailed geomorphic, hydrologic, and geochemical investigation of the lower Glen Rose.

Several studies have examined recharge in the area. Mace et al. (2000) reviewed the estimates, adjusted for period of record differences, and determined that 6.5% of precipitation becomes recharge. However, their study included substantial portions of the poorly permeable upper member of the Glen Rose and gives too low a recharge rate for the Lower Glen Rose Segment of the aquifer. Veni (1997) used streamflow gains and groundwater pumping data to determine mean recharge for the segment as 105,400 acre-feet/year (130.0 million m³/year), or 20.1% of precipitation which is used in this report and applied to Table 4.

South Central Segment

This segment of the aquifer covers much of central Burnet and northwestern Travis counties. It is predominantly comprised of the upper and lower member of the Glen Rose Formation. Permeability in this part of the Glen Rose is lower than in the Lower Glen Rose Segment, with cavernous permeability being uncommon. Baker et al. (1990) and Bluntzer (1992) each examined portions of this aquifer segment, located on the fringe of each investigation's study area. The general hydrogeologic conditions reported by Mace et al. (2000) are more representative of the South Central Segment, so their determination that 6.5% of precipitation becomes recharge is adopted and used in Table 4 because it is consistent with reported hydrogeologic parameters in this aquifer segment.

North Central Segment

The outcrop of the Antlers and Travis Peak formations throughout most of Comanche, Eastland, Erath, and Hood counties, and parts of some adjacent counties, comprises this study's North Central Segment of the Trinity Aquifer. Both the Antlers and Travis Peak are formed of alternating beds of limestone, dolomite, siltstone, and shale. The units occur on ridge tops at the northwestern edge of the Lampasas Cut Plain physiographic region. A detailed investigation of the area by Klemm, Perkins, and Alvarez (1975) determined that 4% of precipitation becomes recharge which is adopted for this study and used in Table 4.

Northern Segment

The Northern Segment of the Trinity Aquifer is defined for this study as the general outcrop of the Antlers, Paluxy, and Twin Mountain Formations in northwest Parker and central Wise and Montague counties. Increasing amounts of silt, sand, and shale occur with the limestone in these units as compared to their equivalent outcrops to the south. Unlike several aquifers, there is consensus on the rate of recharge into this segment of the Trinity Aquifer. Muller and Price (1979), Nordstrom (1982), and Langley (1999) all agree 1.5% of precipitation becomes recharge which is adopted for this study and used in Table 4.

APPENDIX G

ATTACHMENT I

TEXAS WATER DEVELOPMENT BOARD

Review of the Draft Final Report: Contract No. 2000-483-343

“Assessment of Weather Modification as a Water Management Strategy”

1. TWDB strongly recommends that the overall report text be edited to both better reflect the hypothetical nature of the analysis and conclusions regarding predicted seeding effects and the resulting available water quantities, and to emphasize the nature of the results of this research as an indicator for “set [ing] the stage” for additional scientific research. (See page 186, paragraph two, which comes closest to characterizing the usefulness of the research results.) The overall report conclusions, which are primarily based on predicted seeding effects, currently fail to reflect a sufficiently tentative tone in light of: the lack of conclusive scientific evidence regarding cloud seeding effects in Texas; the major and apparently arbitrary assumptions employed in the study; and, the potentially large, yet unexplained, cumulative effect of data and methodological assumptions (e.g. for rainfall estimates on page 25).

The following points illustrate these concerns:

- In contrast to the scientifically-based reservations regarding the efficacy of cloud seeding chronicled within this report (pages 19, 20, 22, Appendix A, and page 239), the conclusions of this report are based on estimated seeding-induced effects, perhaps some conjecture, assumptions suggested based by past results, and other assumptions that may be arbitrary in nature.
- (On page 22) “Although the poor correlations... make the accuracy of these problematic, it is still *likely* that the natural rainfall variability favored the S sample *to some extent*.” [Emphasis added.]
- (Also on page 22) “These results *suggest* that seeding increases rain volume...” [Emphasis added.]
- (Also on page 22) “...provides strong *but not conclusive* evidence for the efficacy of cloud seeding...” [Emphasis added.]
- (On page 26) “At worst the radar estimates ...are *probably* in error by no more than $\pm 20\%$.” [Emphasis added.]
- (Also on page 26) “...probably on the order of 10%.”
- (On page 34, first paragraph) “Thus, the estimates of hypothetical seeding effects are likely too high in view of current seeding practice, which often falls well short of the ideal.”
- (On page 34, third paragraph) “In view of the many acknowledged uncertainties...”
- The report does not clearly convey the importance or potential impact of the most critical assumption in this report, the selection of the assumed hypothetical seeding effect(s). The critical underlying and admittedly “problematic” (page 61, last paragraph) assumption, the +43% seeding factor chosen for this study of Texas (page 26, first paragraph) is presented as a calculated factor when, it apparently is not based on Texas data, but rather Thailand, and was not derived from a statistically accepted process, nor scientifically confirmed by data. This critical assumption is based on a single, subjective comparison between two experimental results; both of which ended with a ‘not significant’ (P-value >.05) result and with one (Thai) value based on an

experiment wherein a significant number of the seeding flares apparently failed. (Thus, bringing into question the validity of the results.) In response to this concern, it is recommended that the report include at least a brief discussion of the potential problems and risks associated with deriving conclusions that are based on this major assumption. This discussion should be presented both within the executive summary and also the methodological sections of the final report.

- The 'conservative' selections of the one-half (max), one-quarter (expected), and one-eighth (minimum) seeding effect values (noted on page 26, first paragraph) are apparently based entirely on the author's experience or intuition and are applied to an apparently unconfirmed base value.
 - The specific complex cloud physics model on which the report relies has not been confirmed or verified and would probably not be acceptable to the general scientific community.
 - Report conclusions are based on numerous assumptions regarding "...an exceptionally complicated undertaking involving complex cloud and environmental processes that are poorly understood." (See page 71.)
 - "Proof of seeding-induced area rainfall increases does not yet exist." (See page 78.) "...although there are tantalizing 'indications' that cloud seeding increases rainfall." and "...a yet unproven technology." (Page 190).
2. It is recommended that a section of text (at least one paragraph) be added within the Executive Summary called 'Major Study Assumptions and Uncertainties' that briefly and clearly explains the premise of the study (that cloud seeding can increase area rainfall) and the importance and subjective nature of the assumed seeding-induced effects on which the entire report is based, and how that some of the assumed effects (the one-half (max), one-quarter (expected), and one-eighth (minimum)) were, in turn, derived from the underlying (+43%) factor. A clear explanation should be included regarding the assumed mechanisms of cloud seeding, for example, and how it was assumed that seeding operations would cause increased rainfall throughout entire storm systems for the entire life of the storm system, in lieu of just local, short-term precipitation effects, as some might argue. Describe and explain the range and significance of the hypothetical seeding effects, which apparently range from a -15% to a +174%, as per Tables 6 and 12.
3. It is recommended that the Executive Summary appropriately portray the sequence of steps and assumptions taken to arrive at final water quantity estimates. Also, at least in broad terms, an explanation of how changes to the study assumptions and both data and methodological errors might impact the estimates of hypothetical water supply quantities should be presented. Also within this section, a brief summary and discussion of the various types of theory and data uncertainties and the potential likelihood of ensuing cumulative errors including "extrapolation" (page 88) should be presented.

The elements contributing to water quantity estimates that should be mentioned include, but are not limited to:

- The fundamental, yet unconfirmed, presumption that cloud seeding will increase area rainfall amounts.
- All unconfirmed assumptions regarding the cloud seeding physics model that were employed.
- All assumptions regarding the overall seeding effects on rainfall amounts reaching the ground (overall magnitude, daily vs. monthly values, etc.).

- The assumption that the effects of cloud seeding in Thailand would be the same as in Texas.
 - Any assumption of a variation in seeding effects among various cloud types.
 - Assumptions made regarding ground conditions and their effect on runoff and infiltration, etc.
 - Extrapolations of radar data across time gaps.
 - Assumptions about the natural variability of rainfall.
 - Simplifications of geography, hydrology and climactic systems.
 - Errors in rain gage data.
 - Errors and inconsistencies in the interpretation of satellite and radar images.
 - Assumptions with regard to the effectiveness of actual seeding operations (e.g. flares).
 - Assumptions regarding the geographic and temporal extent to which cloud seeding operations could actually affect large cloud systems.
 - Arbitrary selection and reduction of hypothetical seeding effects.
 - Assumptions regarding evapotranspiration.
 - Assumptions regarding anticipated runoff.
 - Assumptions regarding anticipated groundwater recharge.
4. The Executive Summary should explain why, despite the numerous uncertainties, data gaps, and major assumptions used, a sensitivity analysis was not developed and presented.
 5. The Draft Report does not clearly characterize the reliability of estimates of water quantities (during normal, below normal, above normal rainfall periods) in light of the lack of certainty of cloud seeding effectiveness and the subsequent analysis.
 6. All references to 'min', 'likely' and 'maximum' SIR (e.g. Tables 14 and 90) throughout the entire report should be changed to 'low', 'middle', and 'high'. The current term 'minimum' implies that no less of a seeding effect would be expected to occur, which is misleading. In light of the enormous uncertainty of the analysis, the term 'likely' doesn't accurately represent the reliability of the associated estimates.
 7. Throughout the entire report, all references to "SIR" (seeding-induced rainfall) should be changed to "HSIR" 'hypothetical seeding-induced rainfall'. This refined terminology more accurately portrays the research methodology, analysis, (per page 33, last paragraph) and resulting conclusions.
 8. A glossary should be presented at beginning of report that clarifies some of the acronyms and terminology used in the report text and tables (e.g. RVOL, Slikely).
 9. The executive summary is unnecessarily wordy and long. Suggest making it clearer and more concise and relating some of the conclusions back to the 5 work scope items.
 10. On page 34, fifth paragraph; the recommendation regarding evaluation of existing programs does not suggest ways to ensure an unbiased evaluation or whether an unbiased and conclusive evaluation is even possible, post facto. Please address this issue in all applicable report sections.
 11. Final report should not include diagrams, maps or graphs that cannot be interpreted without color. The report must be reproducible (and legible) in black and white as per the contract. Including some example color images is acceptable as long as the report does not lose any pertinent information when reproduced in black and white.
 12. Page 29; The report does not appear to provide any supporting information to conclude that the SIR would be less effective in the Hueco-Mesilla Bolson than say in the Ogallala

(although common sense suggests that it is probably true). Please reference where that information can be found.

13. On page 27, the bolded statement is confusing. Why would doubling or tripling of the rainfall be of little consequence?
14. From reading the report, one would conclude that currently there is little reason to consider or presume that cloud seeding can reliably increase available water supplies in response to demand. If so, please state this conclusion in the Executive Summary.
15. It appears that under the proper circumstances and in specific locales cloud seeding might, theoretically, increase precipitation totals, possibly increasing runoff and percolation. Are these appropriate conclusions? If so, please make this clearer in the report and, if not appropriate, please reference applicable sections in the report to confirm.
16. Section of report dealing with 'estimation of additional rainfall' is limited to two pages and two tables. Please provide more information regarding methodology of this task.
17. The draft report seems to rely on too many unknown variables simultaneously.
18. 13.2.3 Aquifer recharge calculations; the report draft may have inadvertently excluded certain of the authors' key thoughts in the last sentence on the first paragraph on page 135. As the sentence appears in the report draft it is unclear what the authors intended to express.
19. Item C, on page 136; Item states that human use of groundwater was not considered and would affect the calculations of SIR induced aquifer recharge. Human consumption of water can place a significant demand on aquifers and cause considerable variation in water levels within the monthly time steps used in the study. Reductions in water levels can significantly increase the volume of recharge that can be accepted by an aquifer.
20. 13.2.5 Aquifer recharge calculations; The first paragraph of page 175 describes the recharge rate of the Lower Glen Rose Segment of the Trinity aquifer as being between 15.7 and 21.7% of precipitation. The text does not describe the water budget study used to calculate the estimated rate of recharge. This rate may be accurate for a specific site, but may not be appropriate for application to the entire aquifer. During development of the Trinity aquifer model, TWDB staff did not identify a published recharge rate calculation greater than 10% of precipitation.
21. The last paragraph on page 176 compares certain artesian aquifers (Edwards, Carrizo-Wilcox, Gulf Coast and parts of the Trinity) with "shallow plateau aquifers" noting that the artesian aquifers have a greater storage capacity, fewer springs and lower groundwater velocity. This characterization contains over-generalizations that are subject to dispute. The Edwards aquifer is noted for very high groundwater velocities and prolific springs. The Trinity aquifer is noted for myriad numbers of small springs. The storage coefficient for water table aquifers is significantly greater than for artesian aquifers.
22. The first paragraph of page 177 describes water levels in portions of the Carrizo-Wilcox and Gulf Coast aquifers as being "close to the surface" and reducing the volume of recharge the aquifers could accept. The author may consider quantifying this statement.
23. 13.4.2 SIR in a typical Edwards aquifer watershed; This section discusses previous work by Land *et al* and Puente in characterizing recharge to the Edwards aquifer by observing stream flow losses gauged on Hondo Creek at Hondo Creek near Tarpley and Hondo Creek at Kings Waterhole stations. It should be noted that the Tarpley gauging station is located on outcrop of the Glen Rose Formation and the Kings Waterhole station is located downstream from a significant outcrop of the Austin Chalk. It is not clear whether the author accurately accounted for the portion of stream losses diverted to these formations when calculating

potential recharge to the Edwards aquifer. This could perhaps account in part for the anomalously high calculated recharge values noted in the discussion on page 181 of the report text. It appears that Land *et al* recognized this phenomenon by noting that 12% of the 315.5 acre-feet/day lost on this stream segment occurred in the "contributing zone" (*i.e.* Glen Rose Fm./Trinity aquifer). The Hondo Creek near Hondo gauging station is located slightly upstream from the Kings Waterhole station and may provide a convenient end point to the observed stream segment.

24. Section 13.4.3; SIR on Edwards aquifer water use versus water recharge areas; Figure 19 on page 184 shows the relationship of precipitation in the San Antonio area and reductions of Edwards aquifer pumping demands that resulted from the precipitation events. It is not clear in the text, whether this data is used to determine the value of "b" in equation 4 on page 138.
25. Section 13.4.3; SIR on Edwards aquifer water use versus water recharge areas; In maintaining a uniformity of method with the Hondo Creek watershed analysis, the researchers did not consider rainfall events of less than 10 million m³ in this analysis. It is of concern that while maintaining this uniformity of method that a bias against small rainfall events was not introduced into the comparison. This is of particular concern considering the admitted underestimate of reduction of pumping on page 184.

Suggested Minor Revisions (Syntax and Clarity)

1. Page 28 item '3'; suggest changing the word "potentially" to "hypothetically".
2. Page 28 item '4'; suggest changing "usually produces" to "hypothetically produces"
3. Page 28 item '4'; suggest changing "are also common" to "hypothetically expected"
4. Page 28 item '4' suggest changing "significant volumes are possible" to "significant volumes are hypothetically possible".
5. Page 28 item '4'; suggest changing "significant volumes are possible" to "hypothetically, greater increases may occur"
6. Page 28 item '5' suggest changing "will probably occur" to "may hypothetically occur"
7. Page 28 item '6' suggest changing "will probably occur" to "may hypothetically occur"
8. Please make associated changes throughout the body of the report to correspond to the changes suggested in the executive summary.
9. Page 28 item '7'; suggest changing "usually produces" to "hypothetically produces"
10. Page 28 item '7'; suggest changing "notable gains may occur" to "hypothetically, notable gains may occur"
11. Page 28 item '7'; suggest changing "Low volumes are also common" to "Low volumes are hypothetically likely"
12. Page 28 item '7'; suggest changing "significant volumes are possible" to "hypothetically, significant increases may occur"
13. Page 29 item '1' under 'Groundwater Studies'; suggest changing "SIR will probably be most effective" to "hypothetically, SIR will probably be most effective".
14. Page 29 item '3' under 'Groundwater Studies'; suggest changing "usually produces" to "hypothetically produces".
15. Page 29 item '2' under 'Edwards Aquifer Focused Studies'; suggest changing "likely recharge of the aquifer could hypothetically be increased" to "hypothetically, recharge of the aquifer could be increased". (As worded under items 5 and 6).
16. Page 29 item '3' under 'Edwards Aquifer Focused Studies'; suggest changing "likely recharge of the aquifer could hypothetically be increased" to "hypothetically, recharge of the aquifer could be increased".
17. Page 29 item '4' under 'Edwards Aquifer Focused Studies'; suggest changing "likely recharge of the aquifer could hypothetically be increased" to "hypothetically, recharge of the aquifer could be increased".
18. Page 31; Delete item '5' regarding techniques of increasing infiltration by drilling into playas overlaying the Ogallala aquifer since it is unrelated to weather modification.
19. Page 33, fourth paragraph, fourth sentence; suggest changing "Although it appears that cloud seeding increases rainfall..." to "Although, to some, it appears that cloud seeding increases rainfall"
20. Page 33, fourth paragraph, sixth sentence; suggest changing "...despite the positive results.." to "despite potentially positive results".
21. Page 33, fifth paragraph, first sentence "Despite the uncertainties, there is enough evidence worldwide that cloud seeding enhances rainfall to justify the existing operational cloud seeding programs in Texas." Delete entire sentence. [This unrelated conclusion is not justified by this research project especially considering statements made elsewhere in the same report including, for example, that "the 'jury is still out' on all attempts to evaluate operational cloud seeding programs" (page 34, paragraph 5), and that

- Texas may have the “cart before the horse” on cloud seeding (page 78)]. Also correct the beginning of the subsequent sentence to compensate for the deletion.
22. Page 33, fifth paragraph, fifth sentence; suggest changing “...cloud seeding could be highly beneficial for some areas in Texas” to “...cloud seeding could be beneficial to some areas in Texas, although the associated costs and resulting benefits are currently uncertain”.
 23. Page 33, fifth paragraph, sixth sentence; suggest changing “Increases in seasonal rainfall...” to “Estimated increases in seasonal rainfall...”.
 24. Page 33, fifth paragraph, sixth sentence; suggest changing “indicated” to “suggested”.
 25. Page 33, fifth paragraph, sixth sentence; suggest changing “...nearly a doubling of the rainfall may be possible...” to “...hypothetically, nearly a doubling of the rainfall may be possible...”.
 26. Page 34, fourth paragraph, first sentence; suggest changing “...likely benefit...” to “possibly benefit”.
 27. Page 35, first paragraph; please elaborate on the reasons why “... some will question the applicability of results obtained in Thailand to Texas.” and how this may reflect on the conclusions of this research (e.g. the role of Thailand’s mountains). (see page 38, paragraph 2)
 28. Page 35, fourth paragraph, second to last and last sentences; “Even so, they [costs] will be small to insignificant relative to many other state and federal programs. Considering the stakes involved, the costs ultimately will be deemed trivial if the effort provides a definitive answer as to whether, how and why cloud seeding affects rainfall in Texas.” Delete both sentences in their entirety. Stated opinions appear premature, and not currently justified by research.
 29. September 27, 2001 draft report incorrectly labeled as “Final Report.” September 27, 2001 report should be labeled ‘Draft Final Report.’ All similar incorrect references to “Final Report” (e.g. pg 15, first paragraph) are incorrect.
 30. Page 17, fourth paragraph; When describing ways of avoiding human bias, executive summary mentions need for ‘randomization’ but fails to mention the function and widely recognized importance of ‘double-blind’ types of experiment precautions and/or whether these precautions have been or are currently employed in Texas or elsewhere.
 31. Page 19, third paragraph; Report fails to point out that, in fact, *neither* of the “two ways to beat this outcome” have been successfully and conclusively employed in a confirmation of cloud seeding efficacy.
 32. Page 19, last paragraph, first sentence; “...the results of relevance to Texas over the years suggest that seeding with an ice nucleant might be useful for enhancing area rainfall.” Delete. Consists of conjecture that is refuted by the sentence immediately following it - “Proof from a single experiment is still lacking.”
 33. Page 19-20, last and first paragraphs; Does not explain the scientific basis for nor characterize the robustness of the 25% to 45% “best estimates” despite the “problematic” (page 22) accuracy of the values on which they are based.
 34. Page 20, first paragraph; Report does not clearly describe the statistical significance or character (e.g. a priori) of any results of evaluations of the effectiveness of cloud seeding programs in Texas or whether associated studies incorporated any double-blind safeguards.

35. Page 28; Report conclusions do not clearly distinguish between below normal, normal and above normal rainfall periods. For example, it is unclear whether cloud seeding should be considered in any location during times of below normal rainfall. Referencing specific months is not adequate to distinguish between these varying hydrologic periods since, for example, the term 'August' has no widely understood or guaranteed climactic/hydrologic meaning.
36. Page 48, first paragraph; Suggest pointing out the natural underlying conflict of interest that presents when someone who performs cloud-seeding for a living is provided with continuous opportunities to influence the data that will be used to evaluate the efficacy of their livelihood.
37. Page 48, first paragraph, last sentence; "Although this [bias] is a logical possibility, there is no evidence for human bias entering into the conduct and evaluation of these experiments." Delete entire sentence or provide specific references to scientific studies that investigated this question and that substantiate this claim.
38. Page 50, last paragraph, fourth sentence; "Human bias is probably less of a problem now than it was for early cloud seeding experiments." Delete entire sentence or provide specific scientific references and studies that substantiate this claim.
39. Page 77, last paragraph, last sentence; suggest changing "the most conservative estimate" to "a conservative estimate, based on the assumed Thai results." (The 'most conservative' overall estimate would be 'zero'.)
40. Page 78, fifth Summary item bullet; suggest changing "Some experiments have produced inconclusive results." to "Most experiments have produced inconclusive results"
41. Page 78, Last full sentence; "Although the management of these [cloud seeding] projects is aware of the uncertainty and uncertainty [sic] surrounding cloud seeding, they decided to proceed because the potential benefits exceed the project costs." Delete, "because the potential benefits exceed the project costs." As stated in the report, actual or potential benefits of cloud seeding remain unknown.
42. Page 78, last word, page 79, first sentence. "The initial chapters of this report indicate that the collective decision to proceed with operational cloud seeding programs was justified." Delete entire sentence. Report does not support this opinion. Also, edit subsequent sentence to reflect deletion.
43. Page 81, second paragraph; Appears to include an unbalanced presentation of CRMWD cloud seeding program. Delete paragraph or include additional description of CRMWD program evaluations, describing whether, for example, 'disinterested' scientists scrutinized data and reports and whether opportunities for human bias were eliminated from operations using double blind practices, whether the research is based on a priori experimentation and whether overall statistical confidence of rainfall increases were statistically 'significant'. Provide details and specific research reference for the claimed "40 to 60 percent" increase in crop production, otherwise delete sentence. Comment on whether program data results would be reliable according to standards discussed in Appendix A.
44. Page 81, third paragraph; Appears to include an unbalanced presentation of City of San Angelo cloud seeding program. Delete paragraph or include additional description of program evaluations, describing whether, for example, 'disinterested' scientists scrutinized data and reports, whether opportunities for human bias were eliminated from

- operations using double blind practices, and whether the overall statistical confidence of rainfall increases were statistical 'significant'.
45. Page 81, third paragraph; Appears to consist of conjecture. Elaborate on the claimed "27 to 42 percent" increase over a relatively brief climactic period and whether or not this apparent increase was ever conclusively attributed to cloud-seeding and whether or not other factors, for example natural weather variability, could explain this increase.
 46. Page 88, asterisk in third column header of Table 6 is not associated with any footnote.
 47. Page 97, Table is not labeled.
 48. Page 97; There is no reference key or other reference provided for identifying areas (e.g. 'A4' is not specifically referred to anywhere else. Changing the first column in Table 7 to include both the number and letter would solve this confusion (e.g. by changing '1' to 'A1').
 49. Page 99, paragraph 4, second to last sentence; Suggest deleting entire sentence. It is obvious that the Table 12 values would have to agree with the Thailand numbers since they are based on the Thai numbers in the first place.
 50. Page 99, paragraph 4, last sentence; suggest deleting or rewording sentence to reflect the great uncertainty inherent in the values.
 51. Page 106; Suggest clarifying units of Table 14.
 52. Page 129, first sentence; Suggest replacing the word "general" with "hypothetical".
 53. Page 129, second paragraph, first and second sentences; suggest inserting the word "hypothetical" between "of" and "SIR" in both sentences.
 54. Page 129, suggest replacing header "13.2.1 Seeding-induced rainfall (SIR)" with "Hypothetical seeding-induced rainfall (HSIR)".
 55. Page 129, fourth paragraph, third sentence; Suggest changing the grammar to reflect the hypothetical nature of the discussion. Suggest changing the word "will" to "would" or "might".
 56. Pages 139-144; Suggest changing the titles of Table 25-36 to reflect the hypothetical nature of the estimates, for example "Estimated potential effects of HSIR on surface water in the"
 57. Page 145; Suggest changing header "13.3.3 General surface water impacts of SIR" to read, for example, "13.3.3 Potential surface water impacts of HSIR".
 58. Pages 146-151; Suggest changing the titles of Table 37-48 to reflect the hypothetical nature of the estimates, for example to "Estimated gains in rainfall (P) from HSIR, uniformly distributed in..." (for example, see Table 88 header).
 59. Page 154; suggest changing header "13.3.4 Streamflow impacts of SIR" to read "13.3.4 Estimated potential streamflow impacts of HSIR".
 60. Pages 155-160; Suggest changing the titles of Table 49-60 to reflect the nature of the estimates, for example; "Estimated effects of HSIR on the flow of...".
 61. Page 161-162, second and third paragraphs; reword text of both paragraphs to reflect the hypothetical nature of the analysis.
 62. Pages 162-174; Suggest changing the titles of Table 61-85 to reflect the hypothetical nature of the estimates, for example "Estimated potential effects of HSIR on recharge of the...".
 63. Page 175, last paragraph; Suggest rewording text of paragraph to reflect the hypothetical nature of the analysis. (e.g. insert "hypothetical" before SIR, replace "will" with "would").

64. Page 177, second paragraph; Suggest rewording text of paragraph to reflect the hypothetical nature of the analysis. (e.g. insert "hypothetical" before SIR, replace "generally" with "would generally").
65. Page 179, Table 87; Suggest rewording table title to reflect the hypothetical nature of the analysis. For example "Estimated effects of mean annual recharge from HSIR on the ..."
66. Page 183, Table 89; Suggest rewording table title to reflect the hypothetical nature of the analysis. (e.g. "Estimated effects of HSIR on.....")
67. Page 184, first paragraph, last sentence; Suggest rewording text of paragraph to reflect the hypothetical nature of the analysis.
68. Page 185, Table 90; Suggest rewording table title to reflect the hypothetical nature of the analysis. (e.g. "Estimated effects of HSIR on.....")
69. Page 185, Table 91; reword table title to reflect the hypothetical nature of the analysis. (e.g. "Comparison of estimated Edwards Aquifer")
70. Pages 186-187; Suggest modifying text throughout to reflect the same changes as those suggested for the Executive Summary as described in comments #8-24 above.
71. Include third paragraph from page 190 in the Executive Summary of report.
72. Page 218; Suggest adding dollar symbols to indicate cost values in Table 94.
73. Page 218-220, Table 94; Costs do not appear to include all overhead costs (e.g. overhead of pilot salaries). Please include these costs in the estimates, as they may be substantial.
74. Page 221, fourth paragraph; if possible, please indicate the relative magnitudes of potential data collection and analysis costs as this work is recommended by the report.
75. Page 222, second paragraph, first sentence; "Despite the uncertainties, there is enough evidence worldwide that cloud seeding enhances rainfall to justify the existing operational cloud seeding programs in Texas." Delete entire sentence. This unrelated opinion is not justified by this research project especially considering statements made elsewhere in the same report including, for example, that "the 'jury is still out' on all attempts to evaluate operational cloud seeding programs" (page 34, paragraph 5), and that Texas may have the "cart before the horse" on cloud seeding (page 78), etc. Suggest also correct the beginning of the subsequent sentence to compensate for this deletion.
76. Pages 223, last sentence and page 224 first partial and first full sentences; "Even so, they [costs] will be small to insignificant relative to many other state and federal programs. Considering the stakes involved, the costs ultimately will be deemed trivial if the effort provides a definitive answer as to whether, how and why cloud seeding affects rainfall in Texas." Suggest deleting both sentences in their entirety. Stated opinions are both irrelevant to, and unjustified by the research.
77. The vertical scales used on Figures 17 and 18 show orders of magnitude value increases in an equally spaced linear fashion. Please more clearly indicate and explain that a log scale is being used in order to avoid misinterpretation of figure by readers unfamiliar with this concept.
78. The acronym convention employed in Figures 17 and 18 is not explained and may be confusing. The authors should consider including an explanatory note and grouping together the various segments of aquifers included in the study.