

DRAINAGE CRITERIA
and DESIGN MANUAL
KLEBERG COUNTY, TEXAS

SOUTH TEXAS WATER AUTHORITY

October, 1986

Prepared by

HDR Infrastructure, Inc.
Austin, Texas

Naismith Engineers, Inc.
Corpus Christi, Texas

TABLE OF CONTENTS

<u>SECTION</u>	<u>PAGE</u>
1 - INTRODUCTION	
1.10 Purpose	1-1
1.20 Objectives	1-1
1.30 Planning Requirements	
1.31 Coordination of Planning Efforts	1-2
1.40 Design Requirements	1-2
1.41 Design Storm Frequencies	1-3
1.42 Initial Storm Provisions	1-3
1.43 Major Storm Provisions	1-3
1.44 Hydrologic Analysis	1-3
1.45 Maximum Permissible Flooding	1-3
1.46 Channels	1-4
1.50 Coordination With Master Plan Maps and Profiles	1-4
1.60 Plan Submittal Standards	1-5
2 - STORM RUNOFF	
2.10 General	2-1
2.20 Rational Method	2-1
2.21 Runoff Coefficient, C	2-2
2.21.1 Nature of Surface	2-2
2.21.2 Soil	2-3
2.21.3 Using the Runoff Coefficient	2-3
2.22 Rainfall Intensity, i	2-4
2.23 Time of Concentration	2-4
2.23.1 Overland Flow	2-8
2.23.2 Storm Sewer or Road Gutter Flow	2-8
2.23.3 Channel Flow	2-8
2.30 Cypress Creek Method	2-11
3 - STREET FLOW	
3.10 General	3-1
3.20 Effects of Stormwater on Street Capacity	3-1
3.21 Interference Due to Sheet Flow Across Pavement	3-1
3.21.1 Hydroplaning	3-2
3.21.2 Splash	3-2
3.22 Interference Due to Gutter Flow	3-2
3.23 Interference Due to Ponding	3-3
3.24 Interference Due to Water Flowing Across Traffic Lane	3-3
3.25 Effect on Pedestrians	3-4

3.30	Design Criteria	3-4
3.31	Street Capacity for Initial Storms	3-4
	3.31.1 Pavement Encroachment	3-4
	3.31.2 Calculating Theoretical Capacity	3-6
	3.31.3 Allowable Gutter Flow	3-6
3.32	Street Capacity For Major Storms	3-6
	3.32.1 Allowable Depth and Inundated Area	3-6
	3.32.2 Calculating Theoretical Capacity	3-6
	3.32.3 Allowable Flow For Major Storm	3-6
3.33	Ponding	3-10
	3.33.1 Initial Storm	3-10
	3.33.2 Major Storm	3-10
3.34	Cross Street Flow	3-10
	3.34.1 Depth	3-10
	3.34.2 Theoretical Capacity	3-10
	3.34.3 Allowable Quantity	3-10
3.40	Intersection Layout Criteria	3-12
3.41	Gutter Capacity, Initial Storm	3-12
	3.41.1 Pavement Encroachment	3-12
	3.41.2 Theoretical Capacity	3-12
	3.41.3 Allowable Capacity	3-12
3.42	Gutter Capacity, Major Storm	3-14
	3.42.1 Allowable Depth and Inundated Area	3-14
	3.42.2 Theoretical Capacity	3-14
	3.42.3 Allowable Capacity	3-14
3.43	Ponding	3-14
	3.43.1 Initial Storm	3-14
	3.43.2 Major Storm	3-14
3.44	Cross Street Flow	3-14
	3.44.1 Depth	3-14
	3.44.2 Theoretical Capacity	3-14

4 - INLETS

4.10	General	4-1
4.20	Classification	4-1
4.30	Inlets in Sumps	4-2
	4.31 Curb Opening Inlets and Drop Inlets	4-2
	4.32 Grate Inlets	4-4
	4.33 Combination Inlets	4-4
4.40	Inlets On Grade Without Gutter Depression	4-4
	4.41 Curb Opening Inlets	4-4
	4.42 Grate Inlets On Grade	4-5
	4.43 Combination Inlets On Grade	4-5
4.50	Inlets On Grade With Gutter Depression	4-6
	4.51 Curb Opening Inlets On Grade	4-6
	4.52 Grate Inlets On Grade	4-6
	4.53 Combination Inlets On Grade	4-7
4.60	Use of Figures 4-11 and 4-12	4-19

5 - STORM DRAINS

5.10	General	5-1
5.20	Velocities and Grades	5-1
5.21	Minimum Grades	5-1
5.22	Maximum Velocities	5-1
5.23	Minimum Diameter	5-1
5.30	Materials	5-4
5.40	Full or Part Full Flow In Storm Drains	5-4
5.41	General	5-4
5.42	Pipe Flow Charts	5-5
5.50	Hydraulic Gradient and Profile of Storm Drain	5-5
5.60	Manhole Locations	5-6
5.70	Pipe Connections	5-6
5.80	Minor Head Losses at Structures	5-7
5.90	Utilities	5-11

6 - OPEN CHANNEL FLOW

6.10	General	6-1
6.20	Channel Discharge	6-1
6.21	Manning's Equation	6-1
6.22	Uniform Flow	6-2
6.23	Normal Depth	6-2
6.30	Design Considerations	6-5
6.40	Channel Cross Sections	6-5
6.41	Side Slope	6-5
6.42	Depth	6-5
6.43	Bottom Width	6-10
6.44	Trickle Channels	6-10
6.45	Freeboard	6-10
6.50	Channel Drops	6-11
6.60	Supercritical Flow	6-11

7 - CULVERT DESIGN

7.10	General	7-1
7.20	Design Criteria	7-1
7.21	Design Frequency	7-1
7.22	Culvert Discharge Velocities	7-1
7.30	Culvert Types	7-2
7.31	Mild Slope Regime, Critical Depth Control (Outlet Control)	7-2
7.32	Mild Slope Regime, Tailwater Depth Control (Outlet Control)	7-5
7.33	Steep Slope Regime, Tailwater Insignificant (Entrance Control)	7-6
7.34	"Slug" Flow Operation (Outlet/Entrance Control)	7-7
7.35	Mild Slope Regime, Tailwater Greater Than Barrel Depth (Outlet Control)	7-8
7.36	Mild Slope Regime, Tailwater Less Than Barrel Depth (Outlet Control)	7-9

7.40	End Treatments	7-10
7.41	Conditions at Entrance	7-10
7.42	Parallel Headwall and Endwall	7-13
7.43	Flared Headwall and Endwall	7-13
7.44	Warped Headwall and Endwall	7-13
7.45	Improved Inlets	7-13
7.50	Culvert Design With Standard Inlets	7-13
7.51	Culvert Sizing	7-14
7.52	Use of Nomographs	7-14
7.60	Design Procedure	7-15
7.61	Design Computation Forms	7-15
7.62	Invert Elevations	7-15
7.63	Culvert Diameters	7-15
7.64	Limited Headwater	7-16

8 - BRIDGES

8.10	General	8-1
8.20	Terminology	8-1
8.30	Flow Through Bridges	8-2
8.40	Single Structure	8-5
8.50	Multiple Structures	8-6
8.51	Flow Distribution	8-6
8.52	Design of Multiple Structures	8-8
8.60	Spur Dikes	8-10

REFERENCES

R-1

LIST OF TABLES

<u>Table</u>		<u>Page</u>
2-1	Rational Method Runoff Coefficients by Land Use Types	2-3
2-2	Rational Method Runoff Coefficients for Composite Analysis	2-5
3-1	Allowable Initial Storm Runoff Encroachment	3-5
3-2	Allowable Major Storm Runoff Inundation	3-7
3-3	Allowable Cross Street Flow	3-11
5-1	Minimum Slope Required to Produce Scouring Velocity	5-2
5-2	Maximum Velocity in Storm Drains	5-3
5-3	Roughness Coefficients "n" for Storm Drains	5-3
5-4	Junction or Structure Coefficient of Loss	5-8
5-5	Head Loss Coefficients Due to Obstructions	5-9
5-6	Head Loss Coefficients Due to Sudden Enlargements and Contractions	5-10
6-1	Composite Roughness Coefficient "n" for Channels	6-6
6-2	Roughness Coefficient "n" for Channels	6-7
7-1	Culvert Discharge Velocity Limitations	7-2
7-2	Culvert Entrance Loss Coefficients	7-4

LIST OF FIGURES

<u>Figure</u>		<u>Page</u>
2-1	Rainfall Intensity-Duration-Frequency Curves for Corpus Christi	2-6
2-2	Travel Time Velocities	2-7
2-3	Rainfall Frequency	2-13
2-4	SCS Runoff Curve Number (<12 in. rainfall)	2-14
2-5	SCS Runoff Curve Number (<40 in. rainfall)	2-15
2-6	Ratio of Instantaneous Peak To Average Runoff Rate per Drainage Area	2-16
2-7	Increase in Peak Discharge Due to Development	2-17
3-1	Nomograph for Flow in Triangular Channels	3-8
3-2	Reduction Factor for Allowable Gutter Capacity	3-9
3-3	Intersection Drainage - Design Conditions	3-13
4-1	Inlet Types	4-3
4-2	Depressed Curb-Opening Inlet	4-8
4-3	Depressed Grate Inlet	4-9
4-4	Depressed Combination Inlet	4-10
4-5	Drop Inlet (Grate Covering)	4-11
4-6	Undepressed Curb-Opening (Recessed)	4-12
4-7	Undepressed Grate Inlet	4-13
4-8	Undepressed Combination Inlet (Recessed)	4-14
4-9	Capacity of Unsubmerged Curb Opening Inlets and Drop Inlets	4-15
4-10	Capacity of Grate Inlets	4-16
4-11	Capacity for Inlets on Grade	4-17
4-12	Curve to Determine Ratio of Intercepted To Total Flow for Inlets On Grade	4-18
5-1	Uniform Flow for Pipe Culverts	5-12
5-2	Critical Depth of Flow for Circular Conduits	5-13
5-3	Velocity in Pipe Conduits	5-14
5-4	Uniform Flow for Concrete Elliptical Pipe	5-15
5-5	Critical Depth for Elliptical Pipe	5-16
5-6	Velocity in Elliptical Pipe	5-17
5-7	Uniform Flow for Pipe-Arch	5-18
5-8	Critical Depth of Flow for Pipe-Arch	5-19
5-9	Velocity in Pipe-Arch	5-20
5-10	Minor Head Loss Due to Turbulence at Structures	5-21
6-1	Uniform Flow for Trapezoidal Channels	6-3
6-2	Manning's Formula Nomograph	6-4
7-1	Mild Slope Regime, Critical Depth Control (Outlet Control)	7-2
7-2	Mild Slope Regime, Tailwater Depth Control (Outlet Control)	7-5
7-3	Steep Slope Regime, Tailwater Insignificant (Entrance Control)	7-6

7-4	"Slug" Flow Operation (Outlet/Entrance Control)	7-7
7-5	Mild Slope Regime, Tailwater Greater Than Barrel Depth (Outlet Control)	7-8
7-6	Mild Slope Regime, Tailwater Less Than Barrel Depth (Outlet Control)	7-9
7-7	Critical Depth of Flow for Circular Conduits	7-11
7-8	Critical Flow for Box Culverts	7-12
7-9	Outlet Control Nomograph - Head for Concrete Box Culverts Flowing Full, $n = 0.012$	7-17
7-10	Inlet Control Nomograph - Headwater Depth for Box Culverts with Inlet Control	7-18
7-11	Outlet Control Nomograph - Head for Concrete Pipe Culvert Flowing Full, $n = 0.012$	7-19
7-12	Outlet Control Nomograph - Head for Standard C.M. Pipe Culverts Flowing Full, $n = 0.024$	7-20
7-13	Inlet Control Nomograph - Headwater Depth for Concrete Pipe Culverts with Inlet Control	7-21
7-14	Inlet Control Nomograph - Headwater Depth for C.M. Pipe Culverts with Inlet Control	7-22
7-15	Design Computation Form	7-23
8-1	Pattern of Flow Through Bridge Openings	8-2
8-2	Turbulence at Headers	8-4
8-3	Backwater	8-4
8-4	Cumulative Conveyance Curve	8-8
8-5	Spur Dike	8-11

SECTION 1 - INTRODUCTION

1.10 PURPOSE

The purpose of this drainage manual is to establish standard principles and practices for the design and construction of surface drainage systems within the unincorporated areas of Kleberg County, Texas. The design factors, formulae, graphs, and procedures are intended for use as engineering guides in the solution of drainage problems involving determination of the rate of flow, method of collection, conveyance and disposal of storm water.

Methods of design other than those indicated herein may be considered in difficult cases where experience clearly indicates they are preferable. However, there should be no extensive variations from the practices established herein without the express approval of the County Commissioners.

1.20 OBJECTIVES

The objectives of the Kleberg County Drainage Manual are:

1. Provide an efficient stormwater drainage system that will minimize private and public property damage resulting from erosion, sedimentation, and flooding; that will protect human life and health; and that will not result in excessive maintenance efforts and replacements in the system.
2. Develop drainage plans that follow natural flow patterns where possible.
3. Ensure that new development does not create a demand for undue public expenditure in flood-control works.
4. Ensure that the design of the drainage system be consistent with good engineering practice and design.
5. Encourage floodplain uses consistent with approved land use plans and policies for the floodplain areas.
6. Provide a mechanism that allows development of areas with minimum adverse effects on the natural environment.
7. Provide a means of informing present and future owners, builders, developers, and the general public of potential flood hazards.

1.30 PLANNING REQUIREMENTS

Storm drainage is a part of the total urban environmental system. Therefore, storm drainage planning and design should be compatible with comprehensive regional development plans.

1.31 Coordination of Planning Efforts

The planning for drainage facilities should be coordinated with planning for open space, utilities, and transportation. By coordinating these efforts, new opportunities are identified which can assist in the solution of drainage problems.

The planning of drainage works in coordination with other urban needs results in more orderly development and lower costs for drainage.

The design and construction of new streets and highways should be fully integrated with drainage needs of the area to provide better streets and highways, to provide better drainage, and to avoid creation of flooding hazards during major storms.

1.40 DESIGN REQUIREMENTS

The design criteria presented in this manual represent sound engineering practice and should be utilized in the Kleberg County Drainage Report. The criteria are not intended to be an iron-clad set of rules within which the planner and designer must work; they are intended to establish guidelines, standards and methods for planning and design. The requirements and criteria set forth in this manual are minimum requirements for development in the County. Criteria that are more conservative and provide a greater degree of flood protection may be acceptable. However, alternative methods of design should be approved by the County Commissioners.

The design criteria shall be revised and updated as necessary to reflect advances in drainage engineering and water resources management.

Governmental agencies and engineers should utilize this manual in the planning of new facilities and in their reviews of proposed works by developers, private parties, and other governmental agencies.

There are many developed areas within Kleberg County that do not conform to the drainage standards projected in this manual. It is recognized that the upgrading of these developed areas to conform to all of the criteria and standards contained in this manual will be difficult if not impossible to achieve, short of complete redevelopment or renewal.

The strict application of this manual in the overall planning of new development is intended to provide a practical and economical means of controlling drainage in the County. In the planning of drainage improvements and the designation of floodplains for developed areas, the use of the criteria and standards contained herein may be adjusted as determined by the County Commissioners.

1.41 Design Storm Frequencies

Storm drainage systems are usually planned to accommodate two levels of storm influx. The initial drainage system handles a 25-year storm event with no disruption of traffic flow or flooding outside the channels. The major drainage system handles the 100-year storm event, perhaps not carrying the load but at least preventing loss of life and major damage. To provide for an orderly community growth, reduce costs to future generations, and prevent loss of life and major property damage, these two separate and distinct drainage systems should be planned and properly engineered.

1.42 Initial Storm Provisions

The initial storm drainage system is necessary to reduce street maintenance costs and to provide against regularly recurring damage from storm runoff.

Design frequencies for the initial storm are discussed in the following sections for each of the respective drainage facilities or appurtenances.

1.43 Major Storm Provisions

Provisions shall be made to prevent property damage and loss of life for the storm runoff expected to have a one-percent chance of occurring in any single year (100-year storm event). Such provisions are known as the major drainage system.

A well planned major drainage system can provide for the initial runoff, and can reduce or eliminate the need for storm sewer systems.

1.44 Hydrologic Analysis

The determination of runoff magnitude shall be by methods described in Section 2. Alternate methods of determining stormwater runoff (such as computer modeling or statistical analysis of flood occurrences) may be used with prior approval of the County Commissioners.

1.45 Maximum Permissible Flooding

The primary use of streets is for traffic. Major streets shall not be used as floodways for initial storm runoff. Reasonable limits of the use of streets for transport of storm runoff shall be governed as described in the following Sections.

Designed on the basis of the initial storm, the storm sewer shall begin where maximum permissible encroachment occurs. The development of major drainage systems that can also drain the initial runoff is encouraged. This technique shifts the point where the storm sewer must begin to a point further downstream.

While it is the intent to have major storm runoff removed from public streets at frequent and regular intervals, it is recognized that storm water will often follow streets and roadways. Therefore, streets and roadways may be aligned so that they provide a specific runoff conveyance function.

1.46 Channels

Wherever possible, natural drainageways should be used for storm runoff waterways. Major consideration must be given to the existing floodplains, location of utilities, and open space requirements of the area.

Natural drainageways within a developing area are too often deepened, straightened, lined, and sometimes put underground. A community loses a natural asset when this happens. Channelizing a natural waterway usually speeds up the flow, causing greater downstream peaks and higher drainage costs downstream. Therefore, alternatives that include new or reconstructed drainage channels should be carefully weighed against the positive environmental and financial considerations of maintaining a natural drainage.

A dedicated maintenance easement shall be provided with all drainage channels. This easement shall provide a minimum access width of 15 feet from the channel bank on each side of the channel unless otherwise designated by the County Commissioners. Dedicated maintenance easements shall be cleared and graded to allow easy access by all required maintenance equipment.

Drainageways having slow flow, grassy bottoms and sides, and wide water surfaces can provide significant storage capacity. This storage is beneficial in that it reduces downstream runoff peaks. This reduces measures needed downstream to offset the impacts of development.

The depth of flow in the receiving stream must be taken into consideration for backwater computations for both the initial and major storm runoffs.

1.50 COORDINATION WITH MASTER PLAN MAPS AND PROFILES

The maps and profiles provided along with the Stormwater Master Plan for Kleberg County should be considered an integral part of this Drainage Criteria Manual. Development in areas identified as being within the 100-year flood boundaries of the major streams within the County will be strictly controlled. The Master Plan Maps show the approximate limits of the 100-year floodplain along the major streams, with the profiles showing the anticipated water surface elevation. Also identified on the maps are areas that are subject to shallow flooding and sheet flow. These areas are divided into two zones, with Zone 1 showing areas of anticipated flooding of one foot or less and Zone 2 showing areas of anticipated flooding of more than one foot.

In the design of outfalls entering the streams identified on the Master Plan Maps, tailwater elevations will be those shown on the maps and profiles or in the report.

1.60 PLAN SUBMITTAL STANDARDS

Preliminary Submittals shall be submitted on sheets 24" x 36" to a horizontal scale of 1" = 100'. For subdivisions in excess of 50 acres, a scale of 1" = 200' may be utilized (for Preliminary Submittal only) if approved by the County Commissioners.

For all other submittals, plan and profile shall be drawn on sheets 24" x 36" to a horizontal scale of 1" to 20', 1" to 30', 1" to 50', 1" to 100' and a vertical scale of 1" to 2' or 1" to 5' (except that scales may vary on special projects, such as culverts and channel cross sections, as approved by the County Commissioners). Contour intervals of not more than 5 feet shall be used in hilly land (over 5% slope), or 1 foot in flatlands or land below elevation 12 feet above mean sea level (MSL).

Good quality copies of the original drawings shall be presented to the County Commissioners prior to the receipt of final approval and shall remain the permanent property of Kleberg County.

Stationing shall proceed upstream. The North arrow shall point to the top of the sheet, or to the right.

Plans for the proposed drainage system shall include property lines, lot and block numbers, dimensions, right-of-way and easement lines, limits of floodplains, street names, paved surfaces (existing or proposed); location, size and type of: inlets, manholes, culverts, pipes, channels and related structures; contract limits; outfall details; miscellaneous riprap construction; contour lines and title block.

Profiles shall indicate the proposed system (size and material) with elevations, flow lines, gradients, left and right bank channel profiles, station numbers, inlets, manholes, ground line and curb line elevations, typical sections, riprap construction, filling details, minimum permissible dwelling elevations, pipe crossings, design flow capacities, and title block.

Areas located within the 100-year flood boundaries, as identified on the Master Plan or Flood Insurance Study Maps, will be shown on the submitted plans. A registered engineer or surveyor will be required to certify the land to be developed as either in or out of the 100-year floodplain or shallow flooding areas. In areas located within the 100-year flood boundaries or shallow flooding areas, buildings, roads, utilities, and all improvements will be protected from floodwaters of the 100-year event. It is preferable that measures be taken, as identified in this manual, to pass the 100-year flood event without affecting pre-development flood levels. In general, floodplain encroachments that increase the pre-development 100-year flood level by more than one foot will not be approved.

In areas identified as being subject to shallow flooding, buildings, roads, utilities, and all other improvements shall be constructed to levels or otherwise protected from floodwaters. Provisions for drainage to these areas shall be as described within this manual.

SECTION 2 - STORM RUNOFF

2.10 GENERAL

This section presents methods for computing storm runoff in the unincorporated areas of Kleberg County. The Rational Method is the primary tool for the determination of runoff from areas of 400 acres or less (Ref. 22). For areas larger than 400 acres, the Rational Method has been shown not to be accurate in determining peak runoff rates, so regional flood estimating techniques or rainfall-runoff procedures become more appropriate for the determination of peak discharge values used for design of drainage systems. The Rational Method is used herein for determining peak runoff rates for areas less than 400 acres, and for larger areas, the Cypress Creek method (Ref. 27) developed by the Agricultural Research Service is recommended. The presentation of these two methods is not intended to preclude the use of other methods of determining storm runoff; however, the use of alternative methods requires approval from the County Commissioners.

2.20 RATIONAL METHOD

The Rational Method is an empirical runoff formula that has gained wide acceptance because of its simple intuitive treatment of storm runoff. This method relates runoff to rainfall intensity, surface area and surface characteristics by the formula:

$$Q = CiA$$

where:

Q = Peak runoff rate in cfs.

C = Runoff coefficient representing a ratio of runoff to rainfall for a duration equal to the time of concentration.

i = Average rainfall intensity in inches/hour.

A = Drainage area of the tributary to the point under consideration in acres.

The Rational Method is based on the following assumptions:

1. The peak rate of runoff at any point is a direct function of the average uniform rainfall intensity during the time of concentration to that point.

2. The frequency of the peak discharge is the same as the frequency of the average rainfall intensity.
3. The time of concentration is the time required for the runoff to become established and flow from the most hydraulically remote part of the drainage area to the point under design. This assumption applies to the portion most remote in time, not necessarily in distance.

Although the basic principles of the Rational Method apply to drainage areas greater than 400 acres, practice generally limits its use to some maximum area. For larger areas, storage and subsurface drainage flow cause an attenuation of the runoff hydrograph so that the rates of flow tend to be overestimated by the Rational Method. In addition, the assumptions of uniform rainfall distribution and intensity become less appropriate as the drainage area increases. Because of the trend for overestimation of flows and the additional cost in drainage facilities associated with this overestimation, the application of a more sophisticated runoff computation technique is usually warranted on larger drainage areas. The designer should obtain permission from the County Commissioners before applying the Rational Method to areas larger than 400 acres. An example problem using the Rational Method is given following Section 2.23.3 (page 2-9).

2.21 Runoff Coefficient, C

The runoff coefficient, C, is the variable in the general equation of the Rational Method which is least susceptible to precise determination and thereby allows some independent judgement. However, uniform application of runoff coefficients can be achieved through the following considerations.

The runoff coefficient accounts for abstractions or losses between rainfall and runoff which may vary with time for a given drainage area. These losses are caused by interception by vegetation, infiltration into permeable soils, retention in surface depressions, and evaporation and transpiration. In determining this coefficient, differing climatological and seasonal conditions, antecedent moisture conditions and the intensity and frequency of the design storm should be considered.

2.21.1 Nature of Surface. The proportion of the total rainfall that will reach the outfall depends on the relative porosity or imperviousness of the surface, and the slope and ponding characteristics of the surface. Semi-impervious surfaces, such as asphalt pavements and roofs of buildings, will be subject to nearly 100 percent runoff, regardless of slope, after the surfaces have become thoroughly wet. On-site inspections and aerial photographs may prove valuable in estimating the nature of the surface within the drainage area.

2.21.2 Soil. The runoff coefficient, C, in the Rational formula is also dependent on the character of the soil. The type and condition of the soil determine its ability to absorb precipitation. The rate at which a soil absorbs precipitation generally decreases as the rainfall continues for an extended period of time. The soil absorption, or infiltration, rate is also influenced by the presence of soil moisture before a rain (due to antecedent precipitation), rainfall intensity, proximity of groundwater table, degree of soil compaction, subsoil porosity, vegetation, ground slopes, and storage capacity of surface depressions.

2.21.3 Using the Runoff Coefficient. Proper use of the runoff coefficient "C" in the general equation of the Rational Method requires judgement and experience on the part of the engineer. Although its use in the formula implies a fixed ratio for a given drainage area, in reality this is not the case. A reasonable coefficient must be chosen to represent the integrated effects of infiltration, detention storage, evaporation, retention, flow routing, and interception, all of which affect the time distribution and peak rate of runoff in a particular watershed. Table 2-1 presents the recommended ranges for "C" values found in the Austin Drainage Criteria Manual (Ref. 1).

TABLE 2-1
RATIONAL METHOD RUNOFF COEFFICIENTS* BY LAND USE TYPES
FOR USE IN $Q = CiA$

<u>Land Use Type</u>	Runoff Coefficients(C) For Basin Slopes		
	<u>Less Than 2%</u>	<u>2% - 7%</u>	<u>Greater Than 7%</u>
Residential	0.40	0.45	0.50
Commercial	0.85	0.87	0.90
Industrial	0.65	0.70	0.75
Undeveloped Land (Clay)	0.33	0.44	0.55
Undeveloped Land (Sandy)	0.13	0.22	0.33

*Reference 1.

It is often desirable to develop a composite runoff coefficient based in part on the percentage of different types of surfaces in the drainage area. The procedure is often applied to typical "sample" blocks as a guide to selection of reasonable values of the coefficient for an entire area. Suggested coefficients with respect to surface types are given in Table 2-2.

In contrast to the runoff coefficient values for storms of 10-, 25- and 100-year frequencies given in Table 2-2, the values in Table 2-1 are limited to 10- and 25-year frequencies. If Table 2-1 is used to determine the 100-year value, it should be adjusted upward accordingly.

2.22 Rainfall Intensity, i

Rainfall intensity, i , is the average rate of rainfall in inches per hour. Intensity is selected on the basis of design frequency of occurrence, a statistical parameter established by design criteria, and rainfall duration. For the Rational Method, the critical rainfall intensity is the rainfall having a duration equal to the time of concentration of the drainage basin.

Rainfall intensity in Corpus Christi, for example, can be determined for various return periods and durations from Figure 2-1, compiled by the U.S. Weather Bureau. These curves are applicable for design frequencies up to the 100-year storm and for durations from 5 minutes to 24 hours.

2.23 Time of Concentration

One of the basic assumptions underlying the Rational Method is that runoff is a function of the average rainfall rate during the time required for water to flow from the most hydraulically remote point of the drainage basin to the point under consideration. Time of concentration then is defined as the time it takes for runoff to travel from the hydraulically most distant part of the watershed to the point of reference. It is usually computed by determining the water travel time through the watershed. Overland flow, storm sewer or road gutter flow, and channel flow are the three phases of direct flow commonly used in computing travel time. Travel time can be estimated for various overland distances by entering Figure 2-2 with known watercourse slope in percent and reading velocity based on watershed ground cover characteristics.

TABLE 2-2
RATIONAL METHOD RUNOFF COEFFICIENTS* FOR COMPOSITE ANALYSIS
FOR USE IN $Q = CiA$

<u>Character of Surface</u>	Runoff Coefficient (C) for Storm Frequency of		
	<u>5 - 10 Years</u>	<u>25 Years</u>	<u>100 Years</u>
Streets, Drives, and Parking Lots:			
Paved	0.85	0.97	0.95
Unpaved	0.75	0.85	0.90
Roofs:	0.85	0.93	0.95
Lawns, Sandy Soil:			
Flat, 0-2%	0.07	0.08	0.09
Average, 2-7%	0.12	0.13	0.15
Steep, 7% or greater	0.30	0.33	0.37
Lawns, Clay Soil:			
Flat, 0-2%	0.18	0.20	0.22
Average 2-7%	0.22	0.24	0.27
Steep, 7% or greater	0.30	0.33	0.37
Undeveloped Woodlands and Pasture Land:			
Sandy Soil:			
Flat, 0-2%	0.12	0.13	0.15
Average, 2-7%	0.20	0.22	0.25
Steep, 7% or greater	0.30	0.33	0.37
Clay Soil:			
Flat, 0-2%	0.30	0.33	0.37
Average, 2-7%	0.40	0.44	0.50
Steep, 7% or greater	0.50	0.55	0.62

*Reference 1.

FIGURE 2-1

RAINFALL INTENSITY-DURATION-FREQUENCY
CURVES FOR CORPUS CHRISTI *

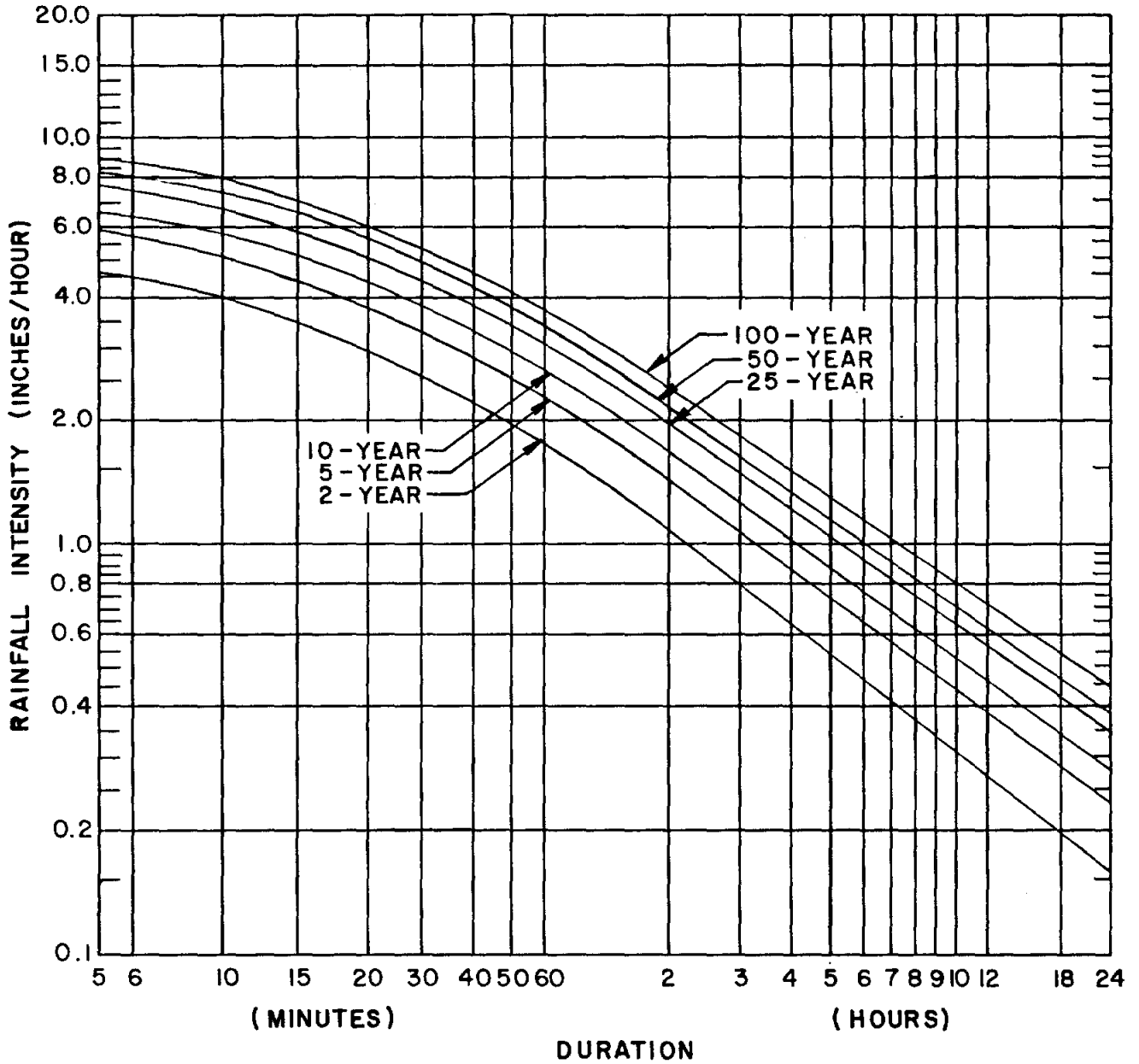

*Reference 5

FIGURE 2-2

TRAVEL TIME VELOCITIES *

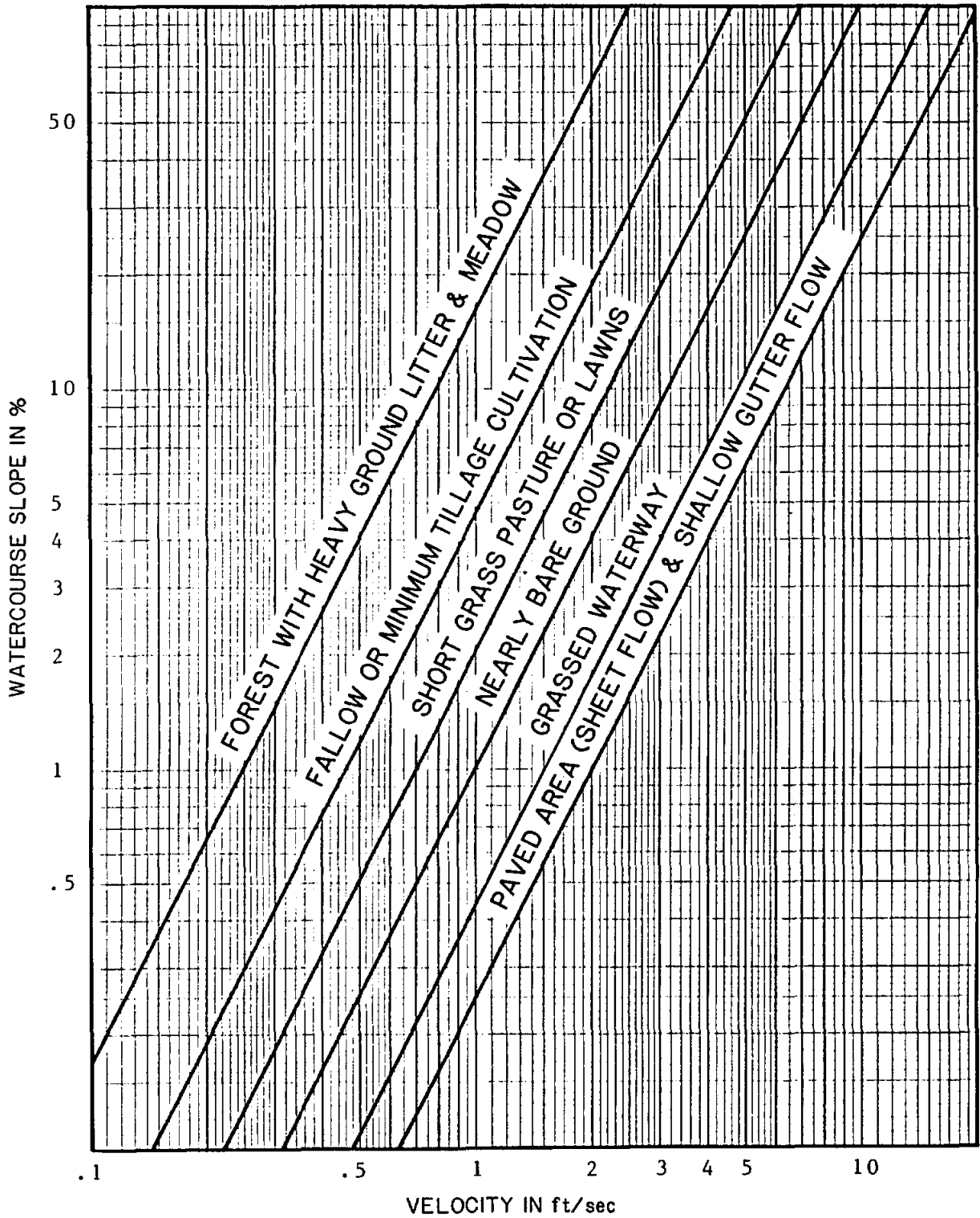

* Reference 24

2.23.1 Overland Flow. The travel time for overland flow consists of the time it takes water to travel from the uppermost part of the watershed to a defined channel or inlet of the storm sewer system. Overland flow is significant in small watersheds because a high proportion of travel time is due to overland flow. The velocity of overland flow can vary greatly with the surface cover and tillage. If the slope and land use of the overland flow segment are known, the average flow velocity can be read from Figure 2-2. The travel time is then computed by dividing the total overland flow length by the average velocity.

Overland flow length should not exceed 300 feet for developed areas or 1,000 feet for undeveloped areas, before being intercepted by a defined channel or storm sewer inlet. Beyond these distances, use gutter flow or channel flow velocities from Figure 2-2 or a more rigorous analysis using Manning's formula (see Example 1).

2.23.2 Storm Sewer or Road Gutter Flow. Travel time through the storm sewer or road gutter system to the main open channel is the sum of travel times in each individual component of the system between the uppermost inlet and the outlet. In most cases average velocities can be used without a significant loss of accuracy. During major storm events, the sewer system may be fully taxed and additional channel flow may occur, generally at a significantly lower velocity than the flow in the storm sewers. By using the average conduit size and the average slope (excluding any vertical drops in the system), the average velocity can be estimated using Manning's formula.

Since the hydraulic radius of a pipe flowing half full is the same as when flowing full, the respective velocities are equal. Travel time may be based on the pipe flowing full or half full. The travel time through the storm sewers is computed by dividing the length of flow by the average velocity. If flow is principally in shallow road gutters, the curve for overland flow in paved areas shown in Figure 2-2 can be used to determine average velocity.

2.23.3 Channel Flow. The travel time for flow in an open channel can be determined by using Manning's equation to compute average velocities. Bankfull velocities should be used to compute these averages. Channels may be in either natural or improved condition.

EXAMPLE 1

Compute the peak runoff rate, Q , for a 25-year storm event from a watershed with the following characteristics:

Drainage area = 85 acres

Land use:

1. Residential (1.5% slope) - 15 acres
2. Commercial (1.5% slope) - 5 acres
3. Undeveloped (Clay soils, 3% slope) - 65 acres

Travel lengths:

<u>Reach</u>	<u>Flow Description</u>	<u>Slope (%)</u>	<u>Length (Ft)</u>
1	Overland (fallow)	3	500
2	Overland (shallow waterway)	2	900
3	Storm Drain (3-foot diameter)	1.2	1000
4	Open Channel (trapezoidal, 5-foot bottom width, 3-foot deep, 3:1 side slopes)	0.5	1500

- Step 1. Compute a composite "C" value.
From Table 2-1 obtain "C" values for land use types and slopes:

Residential - 0.40
Commercial - 0.85
Undeveloped - 0.44

$$\text{Composite } C = \frac{(0.4 \times 15) + (0.85 \times 5) + (0.44 \times 65)}{85} = 0.457$$

- Step 2. Compute Time of Concentration, T_c .

- A. Compute the overland flow travel time.

Reach 1 (undeveloped, minimum tillage). From Figure 2-2 for a slope of 3%, read $v = 0.8$ ft/sec.

$$T = \frac{\text{length}}{\text{velocity}} = \frac{500 \text{ ft.}}{0.8 \text{ ft/sec}} = 625 \text{ sec.}$$

Reach 2 (shallow waterway). From Figure 2-2 for a slope of 2%, read $v = 2.2$ ft/sec.

$$T = \frac{\text{length}}{\text{velocity}} = \frac{900 \text{ ft.}}{2.2 \text{ ft/sec}} = 409 \text{ sec.}$$

B. Compute the storm drain flow travel time.

Reach 3. Use Manning's equation to compute pipe-full velocity.

$$V = \frac{1.49}{n} (R)^{2/3} (S)^{1/2}$$

where:

$$R = \frac{A}{W_p} = \frac{\pi(1.5)^2}{2\pi(1.5)} = \frac{3}{4}$$

$n = 0.015$ for concrete conduit

$S = 0.012$ slope

$$V = \frac{1.49}{.015} \left(\frac{3}{4}\right)^{2/3} (0.012)^{1/2} = 9.0 \text{ ft/sec}$$

$$T = \frac{\text{length}}{\text{velocity}} = \frac{1,000 \text{ ft}}{9 \text{ ft/sec}} = 111 \text{ sec.}$$

C. Compute the open channel flow travel time.

Reach 4. Use Manning's equation to compute bank-full velocity.

$$V = \frac{1.49}{n} (R)^{2/3} (S_f)^{1/2}$$

where:

$n = 0.040$ for channel

$$R = \frac{A}{W_p} = \frac{42}{23.97} = 1.75$$

$S_f = 0.005$ slope

$$V = \frac{1.49}{0.040} (1.75)^{2/3} (0.005)^{1/2} = 3.8 \text{ ft/sec}$$

$$T = \frac{\text{length}}{\text{velocity}} = \frac{1,500 \text{ ft}}{3.8 \text{ ft/sec}} = 395 \text{ sec}$$

D. Hence, the composite travel time,

$$T_c = 625 + 409 + 111 + 395 = 1,540 \text{ sec} = 26 \text{ min.}$$

Step 3. Determine rainfall intensity, i .

For a duration equal to the time of concentration, 26 minutes, determine the 25-year rainfall intensity from Figure 2.1.

$$i = 4.6 \text{ in./hr}$$

Step 4. Compute peak rate of runoff.

$$Q = CiA = 0.457 \times 4.6 \times 85 = 179 \text{ cfs}$$

2.30 CYPRESS CREEK METHOD

The Cypress Creek Method is a procedure for developing peak discharge values in flat, coastal areas. The procedure was developed by the Agricultural Research Service (Ref. 27) to be used in determining the instantaneous peak flow rate for use in channel and structure design. The procedure was developed for rural watersheds, and a graph for increasing the peak discharge rate based on the percent of the watershed developed is included.

The Cypress Creek Method uses the following equation for determining peak discharge values:

$$Q_N = CA^{5/6} R_1 R_2$$

where:

Q = Peak discharge value in cfs.

N = Return period in years.

C = Coefficient based on direct runoff.

A = Drainage area in sq. mi.

R_1 = Ratio of instantaneous peak to peak 24-hour average discharge

R_2 = Ratio of developed to undeveloped peak discharge.

The constant C is computed by the equation:

$$C = 16.39 + 14.75(R_e)$$

where R_e equals the direct runoff amount in inches for return period N . The value for R_e is computed by the Soil Conservation Service (SCS) runoff curve number procedure (Ref. 24).

Figures 2-3 through 2-7 can be used to compute peak discharge values using the Cypress Creek Method. Note that both Figures 2-4 and 2-5 give the SCS runoff curve number, but the latter goes up to 40 inches of rainfall. The following example demonstrates the use of these figures.

EXAMPLE 2

Compute the peak discharge for a 100-year, 24-hour storm event from a watershed with the following characteristics:

Drainage area = 6.52 sq. mi.

SCS runoff curve number = 55. (Note: There are many references for computing the runoff curve number, including Reference 24.)

10 percent of the watershed is developed.

- Step 1. From Figure 2-3, the 100-year, 24-hour rainfall amount is 11.7 in.
- Step 2. From Figure 2-4, the direct runoff amount (R_e) for a curve number of 55 and rainfall amount of 11.7 in. is 5.5 in.
- Step 3. C is computed from the equation

$$C = 16.39 + 14.74(R_e) = 97.5$$

Step 4. From Figure 2-6, the ratio R_1 equals 1.65.

Step 5. From Figure 2-7, the ratio R_2 equals 1.07.

Step 6. Peak discharge is $Q_n = CA^{5/6} R_1 \times R_2$, so

$$Q_{100} = 97.5 \times (6.52)^{5/6} \times 1.65 \times 1.07 = 821 \text{ cfs}$$

FIGURE 2-3

RAINFALL FREQUENCY *

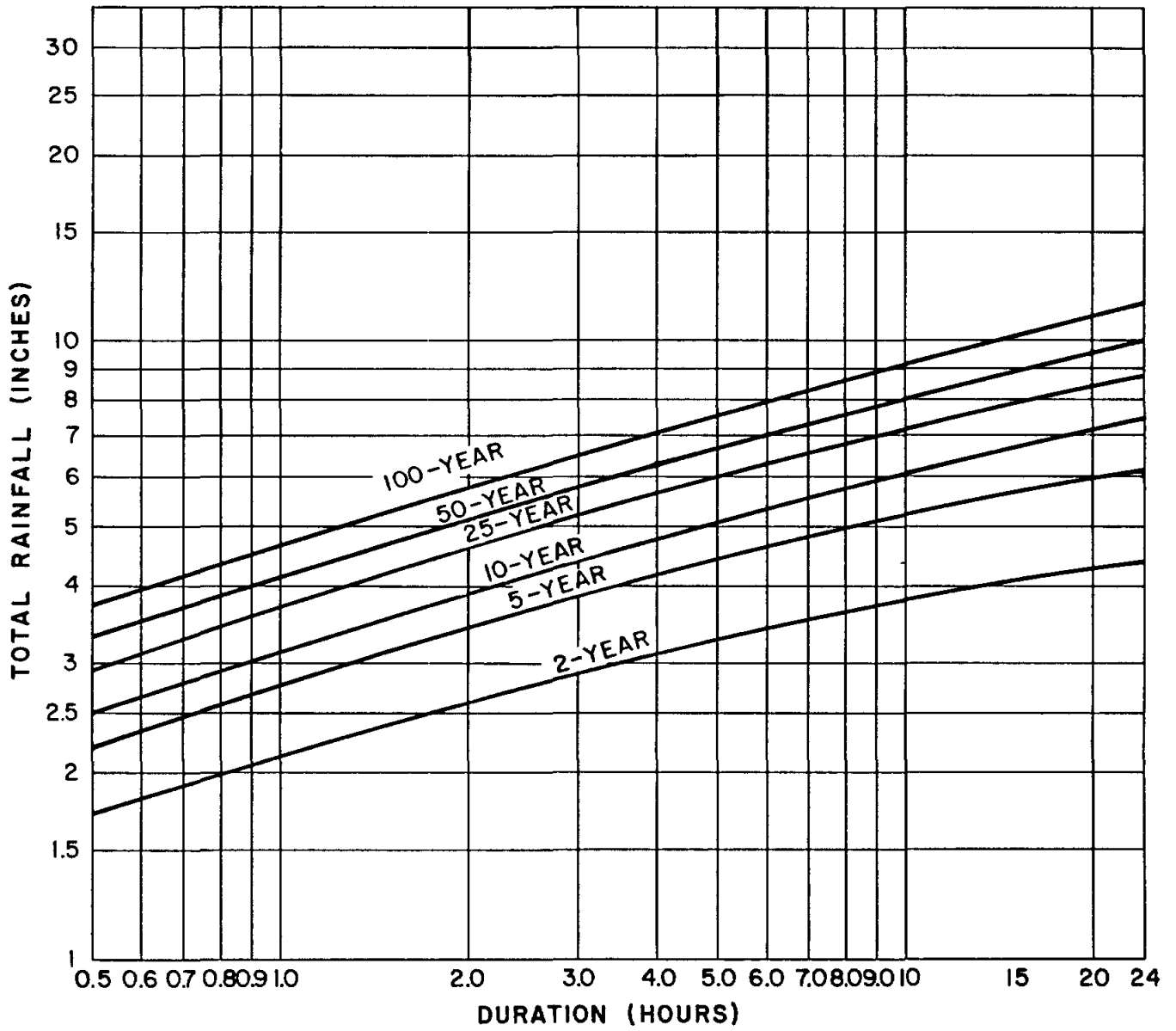

* Reference 6

FIGURE 2-4

SCS RUNOFF CURVE NUMBER
(<12 in. RAINFALL)

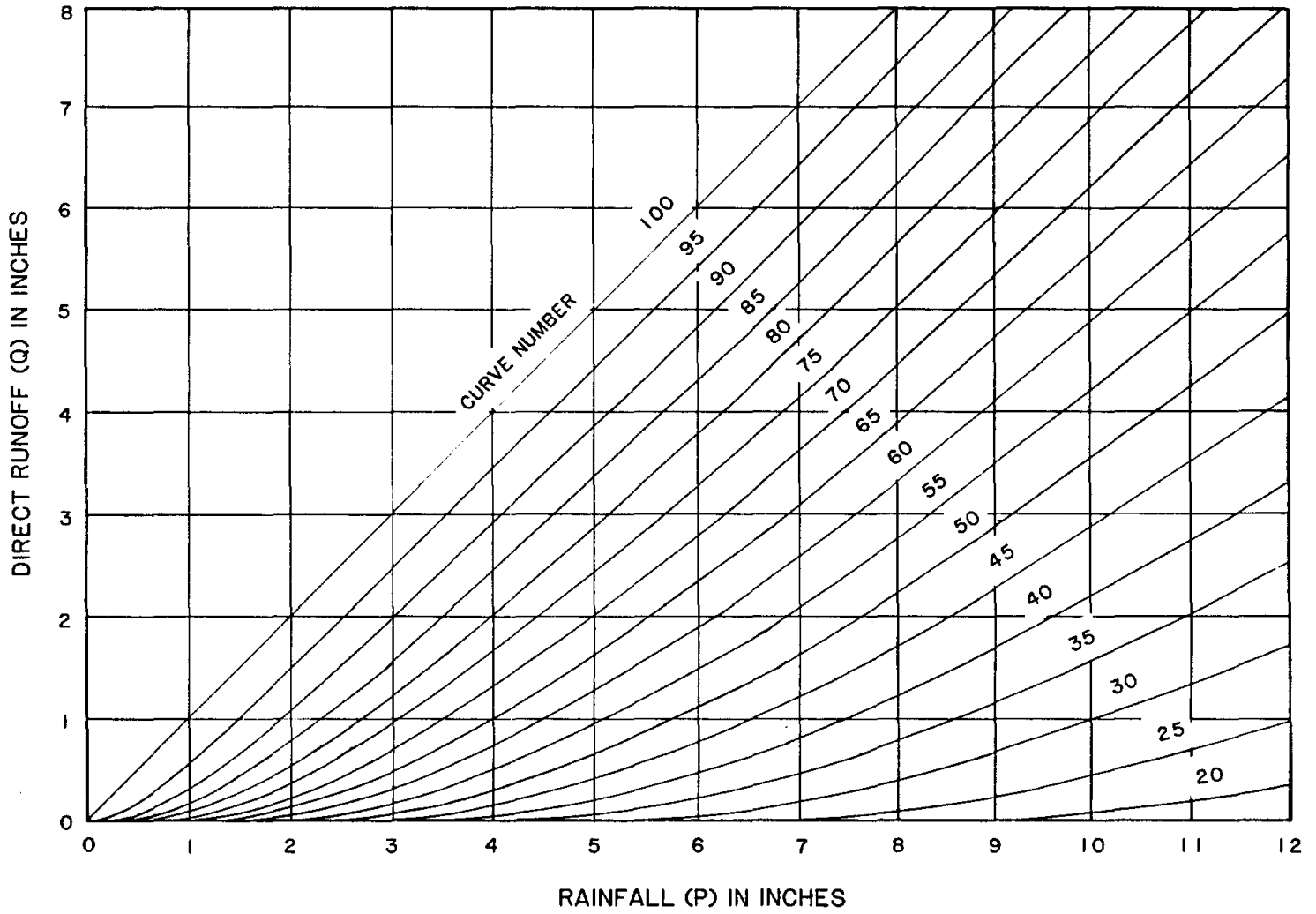

FIGURE 2-5

SCS RUNOFF CURVE NUMBER
(≤ 40 in. RAINFALL)

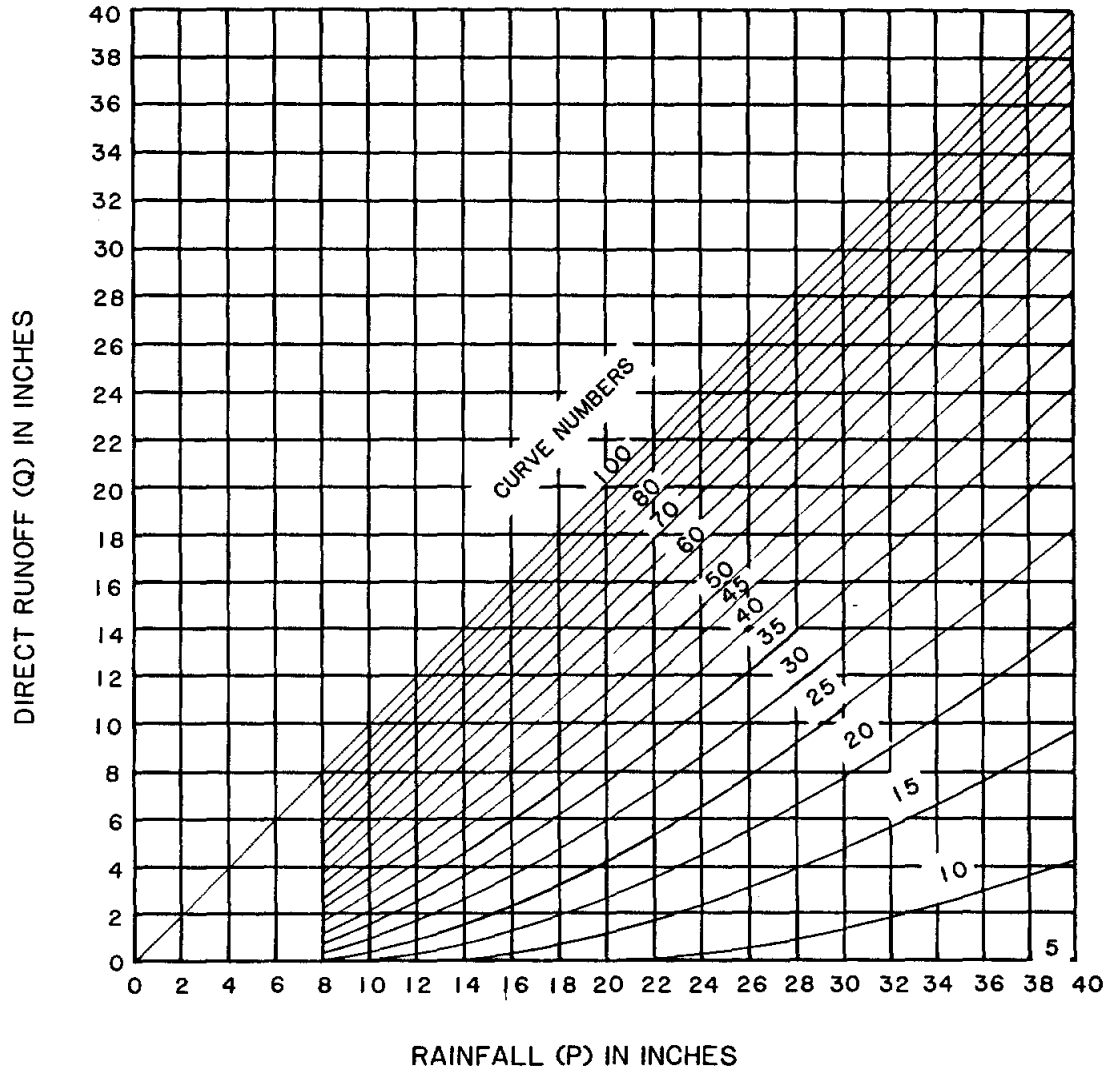

FIGURE 2-6

RATIO OF INSTANTANEOUS PEAK TO AVERAGE RUNOFF
RATE PER DRAINAGE AREA

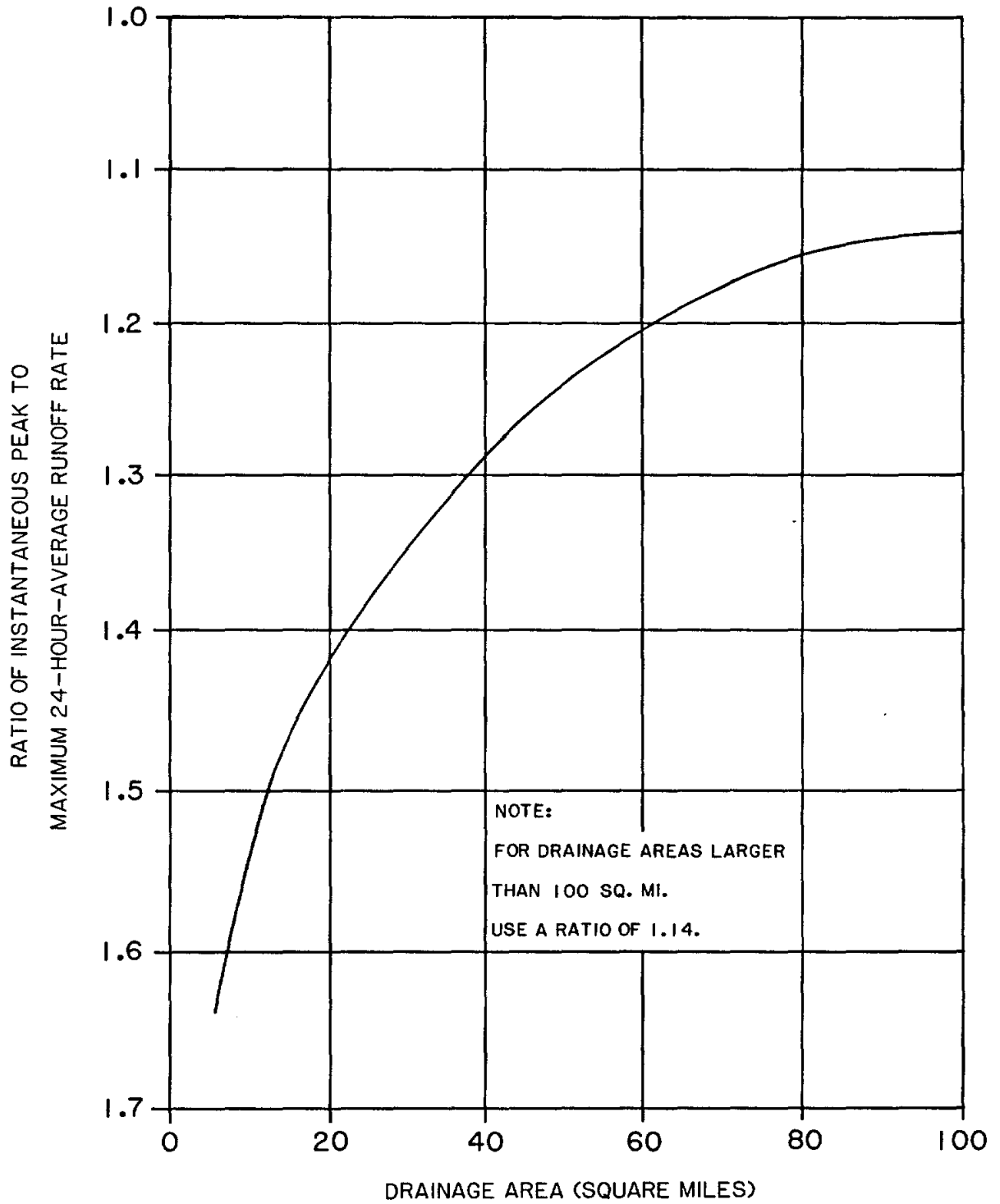
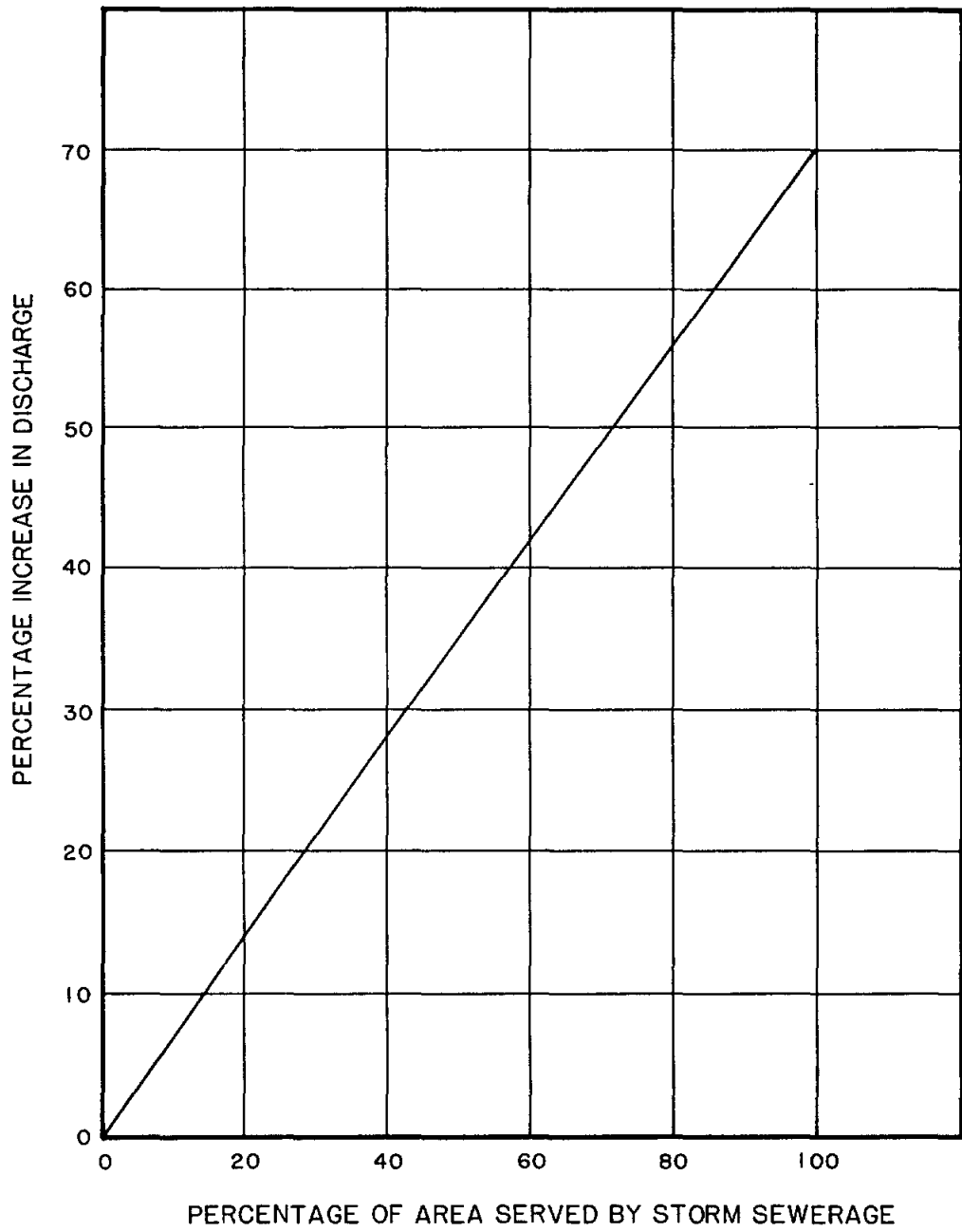

FIGURE 2-7

INCREASE IN PEAK DISCHARGE DUE TO DEVELOPMENT



SECTION 3 - STREET FLOW

3.10 GENERAL

The location of inlets and permissible flow of water in streets is related to the frequency of traffic interference and the possibility of damage to adjacent property.

Streets provide an important and necessary drainage service, even though their primary function is for the movement of traffic. Traffic and drainage uses are compatible up to a point, beyond which drainage must be subservient to traffic needs.

Gutter flow in streets is necessary to transport runoff to storm inlets and to major drainage channels. Good planning of streets can substantially help in reducing the size of, and sometimes eliminating the need for, a storm sewer system in new developments.

3.20 EFFECTS OF STORMWATER ON STREET CAPACITY

The storm runoff which influences the traffic-carrying capacity of a street can be classified as follows:

Sheet flow across the pavement as falling rain flows to the edge of the pavement.

Runoff flowing adjacent to the curb or in roadside ditches.

Stormwater ponded at low points in streets.

Flow across the traffic lane from external sources, cross street flow (as distinguished from water falling on the pavement surface).

Splashing of any of the above types of flow on pedestrians.

Each of these types of storm water runoff must be controlled within acceptable limits so that the street's main function as a traffic carrier will not be unduly restricted.

The effects of each of the above categories of runoff on traffic movement are discussed in the following sections.

3.21 Interference Due to Sheet Flow Across Pavement

Rainfall that falls upon the paved surface of a street or road must flow overland as sheet flow until it reaches a channel. In streets with curbs and gutters, the curb and gutter become the channel, while on roads that have drainage ditches adjacent to them, the ditch becomes the channel. The direction of flow on the street may be determined by the addition of the street grade and the crown slope. The depth of sheet flow

will be essentially zero at the crown of the street and will increase as it proceeds towards the channel. Traffic interference due to sheet flow is essentially of two types, hydroplaning and splash.

3.21.1 Hydroplaning. Hydroplaning is the phenomenon of vehicle tires actually being supported by a film of water that acts as a lubricant between the pavement and the vehicle. It generally occurs at speeds common to freeways or arterial streets, or at turns. Its effect can be minimized either by installing relatively rough pavement that allows water to escape from beneath the tires (i.e., pavement grooving to provide drainage) or by reducing travel speed.

3.21.2 Splash. Traffic interference due to splash results from sheet flow of excessive depth caused by water traveling a long distance or at a very low velocity before reaching a gutter. Increasing the street crown slope will decrease both the time and distance required for water to reach the gutter. The crown slope, however, must be kept within acceptable limits to allow the opening of doors when parked adjacent to curbs. An exceedingly wide pavement section contributing flow to one curb will also affect the depth of sheet flow. This may be due to superelevation of a curve, off-setting of the street crown due to warping of curbs at intersections, or many traffic lanes between street crown and the gutter. Consideration should be given to all of these factors to maintain a depth of sheet flow within acceptable limits.

3.22 Interference Due to Gutter Flow

Water that enters a street, either sheet flow from the pavement surface or overland flow from adjacent areas, will flow in the gutter of the street until it reaches some outlet, such as a storm sewer or a channel. As the flow progresses downhill and additional areas contribute to the runoff, the width of flow will increase and progressively infringe upon the traffic lane. If vehicles are parked adjacent to the curb, the width of spread will have little influence on traffic-carrying capacity until it exceeds the width of the vehicle by several feet. However, on streets where parking is not permitted, as with many arterial streets, whenever the flow width exceeds a few feet it will significantly affect traffic. Field observations show that vehicles will crowd adjacent lanes to avoid curb flow.

As the width of gutter flow increases, it becomes impossible for vehicles to operate without driving through water, and they again begin to use the inundated lane. At this point the traffic velocity will be significantly reduced as the vehicles begin to drive through the deeper water. Splash from vehicles traveling in the inundated lane obscures the vision of drivers of vehicles moving at a higher rate of speed on the open lane.

Eventually, if width and depth of flow become great enough, the street will become ineffective as a traffic-carrier. During these periods it is imperative that emergency vehicles such as fire trucks, ambulances, and police cars be able to traverse the street by moving along the crown of the roadway.

The street classification is also important when considering the degree of interference to traffic. A local street, and to a lesser extent a collector street, could be inundated with little effect upon vehicular travel. The small number of cars involved could move at a low rate of speed through the water even if the depth were four to six inches. However, reducing the speed of freeway or arterial traffic affects a great number of private, commercial, and emergency vehicles.

3.23 Interference Due to Ponding

Storm runoff ponded on the street surface because of grade change or the crown slope of intersecting streets has a substantial effect on the street-carrying capacity. A major problem with ponding is that it may reach depths greater than the curb and remain on the street for long periods of time. Another problem is that ponding is localized in nature and vehicles may enter a pond moving at a high rate of speed.

The manner in which ponded water affects traffic is essentially the same as for curb flow; that is, the width of spread onto the traffic lane is the critical parameter. Ponded water will often bring traffic to a complete halt. In this case, incorrect design of only one facet of an entire street and storm drainage system will render the remainder of the street system ineffective during the runoff period.

3.24 Interference Due to Water Flowing Across Traffic Lane

Whenever storm runoff, other than sheet flow, moves across a traffic lane, a serious impediment to traffic flow occurs. The cross-flow may be caused by superelevation of a curve or flow exceeding the capacity of a higher gutter on a street with cross fall. The problem associated with this type of flow is the same as for ponding in that it is localized in nature and vehicles may be traveling at high speed when they reach the location. If the velocity of vehicles is naturally slow, and use is light, such as on local streets, cross street flow does not cause sufficient interference to be objectionable.

The depth and velocity of cross street flow should always be maintained within such limits that it will not have sufficient force to affect moving traffic. If a vehicle that is hydroplaning enters an area or cross street flow, even minor force could be sufficient to move it laterally towards the gutter.

At certain intersections, the flow may be trapped between converging streets and must either flow over one street or be carried underground. If the vehicles coming to the intersection are already required to stop, then very little hazard exists to the traveling public. This is the basis for the assumption that cross pans are acceptable across a local street where it intersects another local or collector street. Another point in favor of the use of cross pans is when the local street is allowed to coincide with the crown of the major street, the outside traffic lanes of the major street have a built-in hump at the intersection.

3.25 Effect on Pedestrians

In areas where pedestrians frequently use sidewalks, splash due to vehicles moving through water adjacent to the curb poses a serious, adverse sociological impact. It must also be kept in mind that under certain circumstances, pedestrians will be required to cross ponded or flowing water adjacent to curbs.

Since the majority of pedestrian traffic will cease during the actual rainstorm, less consideration need be given to the problem while the rain is actually falling. Ponded water, however, remaining after the storm has passed, must be negotiated by pedestrians.

Streets should be classified with respect to pedestrian traffic as well as vehicular traffic. As an example, streets classified as local for vehicles but located adjacent to a school are arterials for pedestrian traffic. Allowable width of gutter flow and ponding should reflect this fact.

3.30 DESIGN CRITERIA

Design criteria for the collection and moving of runoff water on public streets is based on a reasonable frequency of traffic interference. That is, depending on the character of the street, certain traffic lanes can be fully inundated once during the initial design storm return period, usually once each 25 years. However, during this period, lesser storms occur which will produce runoff and which will inundate traffic lanes to some smaller degree.

Planning and design for urban storm runoff must be considered from the viewpoint of both the regularly expected storm occurrence, that is, the initial storm, and the major storm occurrence. The initial storm will have a frequency of one in 25 years. The major storm will have a return period of 100 years. The objective of the major storm runoff planning and design is to eliminate major damage and loss of life. The initial drainage system is necessary to eliminate inconvenience, frequently recurring minor damage, and high street maintenance.

3.31 Street Capacity For Initial Storms

Determination of initial storm-carrying capacity of the street is based upon two considerations: (a) pavement encroachment for computed theoretical flow conditions, and (b) an empirical reduction of the theoretical allowable rate of flow to account for practical field conditions.

3.31.1 Pavement Encroachment. The pavement encroachment for the initial storm shall be limited as set forth in Table 3-1.

TABLE 3-1

ALLOWABLE INITIAL STORM RUNOFF ENCROACHMENT

<u>Street Classification</u>	<u>Initial Storm Frequency</u>	<u>Maximum Encroachment</u>
Local	10-year	No curb over-topping.* Flow may cover crown of street.
Collector	10-year	No curb over-topping.* Flow spread must leave at least one lane (12 feet) free of water for a two-lane roadway and two lanes for a four-lane roadway.
Arterial	25-year	No curb over-topping.* Flow spread must leave at least one lane free of water in each direction.
Expressway	25-year**	No encroachment is allowed on any traffic lane.

* Where no curbing exists, encroachment shall not extend over property lines except at drainage easements.

** 50-year for a depressed highway cross section.

The storm sewer system should commence at the point where the maximum encroachment is reached, and should be designed on the basis of the initial storm. Development of the major drainage system is encouraged so that the initial runoff is removed from the streets, thus moving the point at which the storm sewer system must begin to a point further downstream.

3.31.2 Calculating Theoretical Capacity. When the allowable pavement encroachment has been determined, the theoretical gutter-carrying capacity for a particular encroachment shall be computed using the modified Manning's formula for flow in shallow triangular channel, as shown in Figure 3-1.

Figure 3-1 may be utilized for all gutter configurations. To simplify computations, graphs for particular street shapes may be plotted. An "n" value of 0.016 shall be utilized for concrete curb and gutter unless special considerations exist.

3.31.3 Allowable Gutter Flow. The actual flow rate allowable per gutter shall be calculated by multiplying the theoretical capacity by the corresponding factor obtained from Figure 3-2. The designer will then be able to develop discharge curves for standard streets.

3.32 Street Capacity For Major Storms

Determination of the allowable flow for the major storm is based upon two considerations: (a) theoretical capacity based upon allowable depth and inundated area, and (b) reduced allowable flow due to velocity considerations.

3.32.1 Allowable Depth and Inundated Area. The allowable depth and inundated area for the major storm shall be limited as set forth in Table 3-2.

3.32.2 Calculating Theoretical Capacity. Based upon the allowable depth and inundated area as determined from Table 3-2, the theoretical street-carrying capacity shall be calculated. Manning's formula shall be utilized with an "n" value applicable to the actual boundary conditions encountered.

3.32.3 Allowable Flow for Major Storm. The actual flow allowable within the street right-of-way shall be calculated by multiplying the theoretical capacity by the corresponding reduction factor obtained from Figure 3-2.

TABLE 3-2

ALLOWABLE MAJOR STORM RUNOFF INUNDATION

<u>Street Classification</u>	<u>Allowable Depth and Inundated Areas</u>
Local and Collector	Residential dwellings, and public, commercial and industrial buildings shall not be inundated at the ground line, unless buildings are flood-proofed. The depth of water over the gutter flowline or centerline of road shall not exceed 18 inches.
Arterial and Freeway	Residential dwellings, and public, commercial and industrial buildings shall not be inundated at the ground line, unless buildings are flood-proofed. Depth of water at the street crown shall not exceed 6 inches, to allow operation of emergency vehicles. The depth of water over the gutter flowline, if street has curb and gutter, shall not exceed 18 inches.

FIGURE 3-1

NOMOGRAPH FOR FLOW IN TRIANGULAR CHANNELS

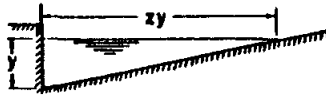

EQUATION: $Q = 0.56 \left(\frac{Z}{n}\right) s^{1/2} y^{5/3}$

Z=RECIPROCAL OF TRANSVERSE SLOPE

n=COEFFICIENT OF ROUGHNESS IN MANNING'S FORMULA

s=GRADE OF CHANNEL IN FT./FT.

y=DEPTH AT CURB OR DEEPEST POINT IN FT.

EXAMPLE (See dashed lines)

GIVEN: $s = 0.03$

$Z = 24$
 $n = 0.02$ } $Z/n = 1200$

$Q = 2.0$ CFS

FIND: $y = 0.22$

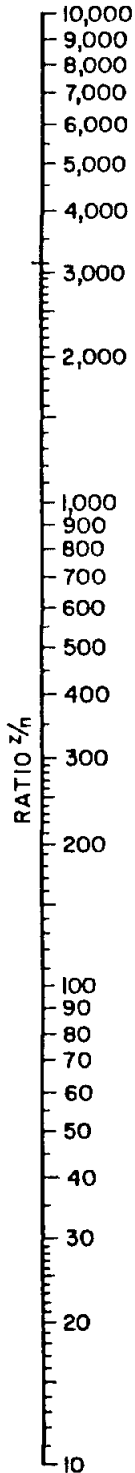

TURNING LINE

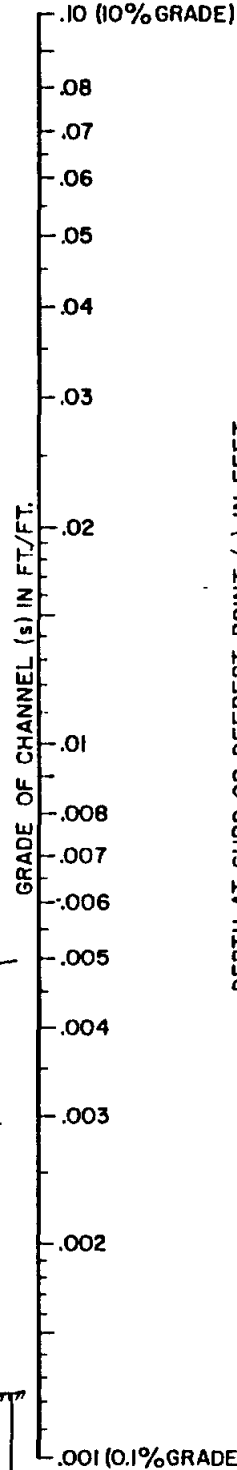
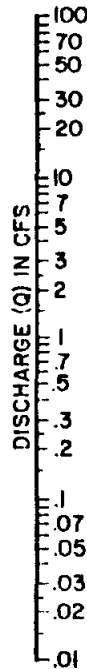

INSTRUCTIONS

1. CONNECT Z/n RATIO WITH SLOPE (s) AND CONNECT DISCHARGE (Q) WITH DEPTH (y). THESE TWO LINES MUST INTERSECT AT TURNING LINE FOR COMPLETE SOLUTION.

2. FOR SHALLOW V-SHAPED CHANNEL AS SHOWN USE NOMOGRAPH TO DETERMINE DISCHARGE IN SECTIONS a AND b SEPARATELY. THEN $Q_T = Q_a + Q_b$

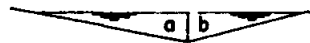

3. TO DETERMINE DISCHARGE Q_x IN PORTION OF CHANNEL HAVING WIDTH x: DETERMINE DEPTH y FOR TOTAL DISCHARGE IN ENTIRE SECTION a. THEN USE NOMOGRAPH TO DETERMINE Q_b IN SECTION b FOR DEPTH $y' = y - (\frac{x}{Z})$.

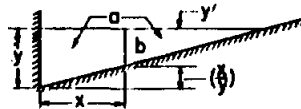

4. TO DETERMINE DISCHARGE IN COMPOSITE SECTION: FOLLOW INSTRUCTION 3. TO OBTAIN DISCHARGE IN SECTION a AT ASSUMED DEPTH y; OBTAIN Q_b FOR SLOPE RATIO Z_b AND DEPTH y' . THEN $Q_T = Q_a + Q_b$.

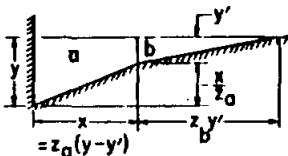
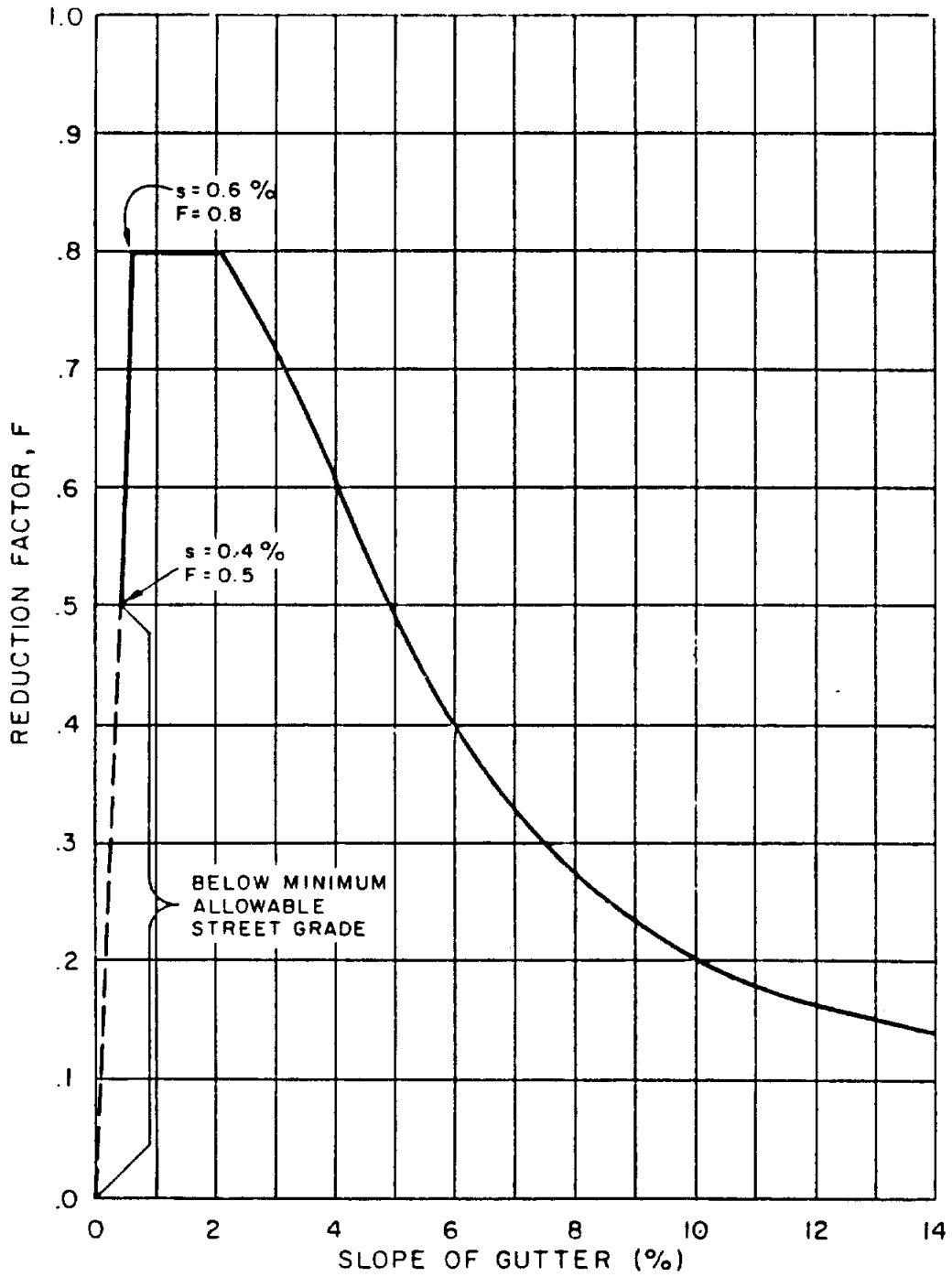

FIGURE 3-2

REDUCTION FACTOR FOR ALLOWABLE GUTTER CAPACITY



3.33 Ponding

The term "ponding" refers to areas where runoff is restricted to the street surface by sump inlets, street intersections, low points, intersections with drainage channels, or other reasons.

3.33.1 Initial Storm. Limitations for pavement encroachment by ponding for the initial storm are those presented in Table 3-1. These limitations shall determine the allowable depth at inlets, gutter turnouts, culvert headwaters, etc.

3.33.2 Major Storm. Limitations for depth and inundated area for major storms are those presented in Table 3-2. These limitations shall determine the allowable depth at inlets, gutter turnouts, culvert headwaters, etc.

Where allowable ponding depth would cause cross street flow, the limitation shall be the minimum allowable of the two criteria.

3.34 Cross Street Flow

Cross street flow comes in two general categories: The first type is runoff that has been flowing in a gutter and then flows across the street to the opposite gutter or to an inlet; the second type is flow from some external source, such as a drainageway, which will flow across the crown of a street when the conduit capacity beneath the street is exceeded.

3.34.1 Depth. Cross street flow depth shall be limited as set forth in Table 3-3.

3.34.2 Theoretical Capacity. Based upon limitations in Table 3-3 and other applicable limitations (such as ponding depth), the theoretical quantity of the flow will vary, and no general rule for a computational method can be made. The Manning equation may be used with appropriate "n" value to estimate theoretical capacity; however, care should be taken in the determination of flow boundaries.

3.34.3 Allowable Quantity. Once the theoretical cross street capacity has been computed, the allowable quantity shall be calculated by multiplying the theoretical capacity by the corresponding factor from Figure 3-2. The slope of the water surface crossing the street shall be used in lieu of the gutter slope.

TABLE 3-3
ALLOWABLE CROSS STREET FLOW

<u>Street Classification</u>	<u>Initial Design Runoff</u>	<u>Major Design Runoff</u>
Local	6-inch depth at crown.	18 inches of depth above gutter flowline.
Collector	Where cross pans allowed, depth of flow shall not exceed 6 inches.	18 inches of depth above gutter flowline.
Arterial	None	6 inches or less over crown.
Freeway	None	6 inches or less over crown.

3.40 INTERSECTION LAYOUT CRITERIA

The following design criteria are applicable at intersections of streets. Gutter carrying capacity limitations covered previously shall apply along the street proper, while this section shall govern at the intersection.

3.41 Gutter Capacity, Initial Storm

3.41.1 Pavement Encroachment. Limitations at intersections for pavement encroachment shall be as given in Table 3-1.

3.41.2 Theoretical Capacity. The theoretical carrying capacity of each gutter approaching an intersection shall be calculated based upon the most critical cross section (see Figure 3-3).

- A. Continuous Grade Across Intersection. When the gutter slope will be continued across an intersection, the slope used for calculating capacity shall be that of the gutter flowline crossing the street.
- B. Flow Direction Change at Intersection. When the gutter flow must undergo a direction change greater than 45 degrees at the intersection, the slope used for calculating capacity shall be the effective gutter slope, defined as the average of the gutter slopes at 0 ft., 25 ft., and 50 ft. from the point of direction change.
- C. Flow Intersection by Inlet. When gutter flow will be intercepted by an inlet on continuous grade at the intersection, the effective gutter slope shall be utilized for calculations. Under this condition, the points for averaging shall be 0 ft., 25 ft., and 50 ft. upstream from the inlet.

3.41.3 Allowable Capacity. The allowable capacity for gutters approaching an intersection shall be calculated by applying a reduction factor to the theoretical capacity.

- A. Flow Approaching an Arterial Street. When the direction of flow is towards an arterial street, the allowable carrying capacity shall be calculated by applying the reduction factor from Figure 3-2 to the theoretical gutter capacity. The grade used to determine the reduction factor shall be the same effective grade used to calculate the theoretical capacity.

FIGURE 3-3

INTERSECTION DRAINAGE - DESIGN CONSIDERATIONS

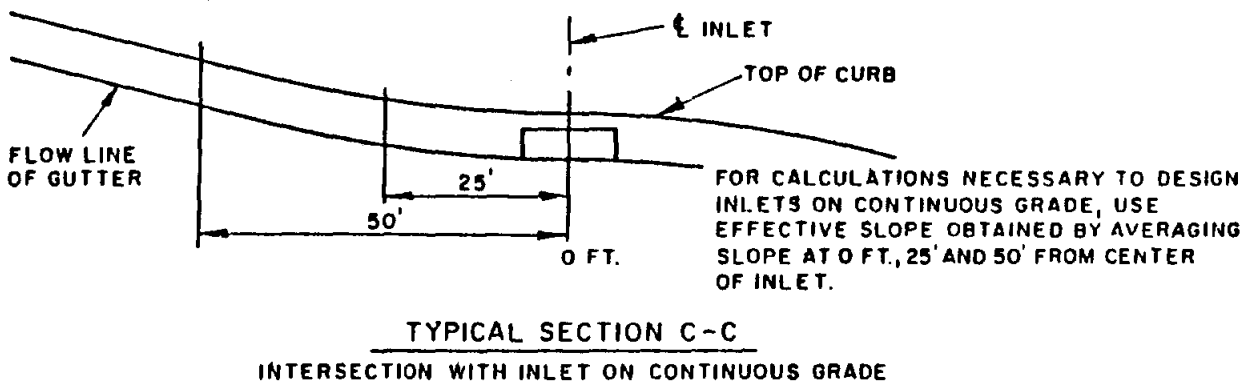
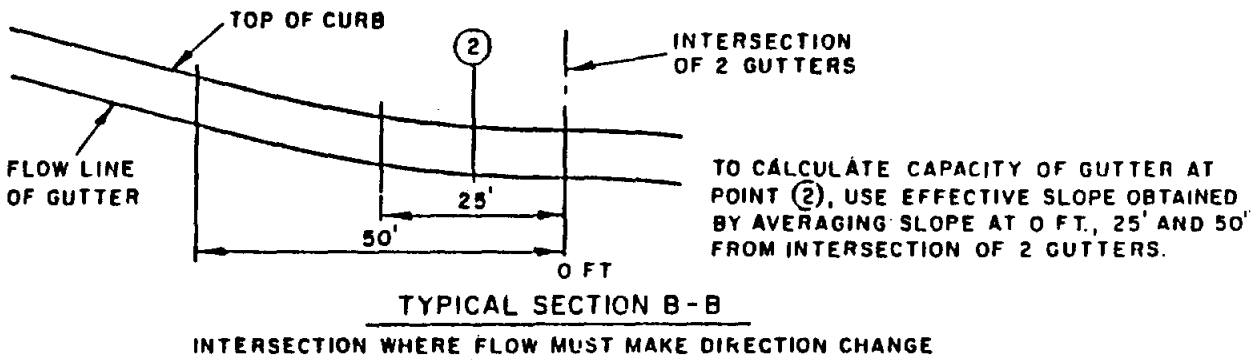
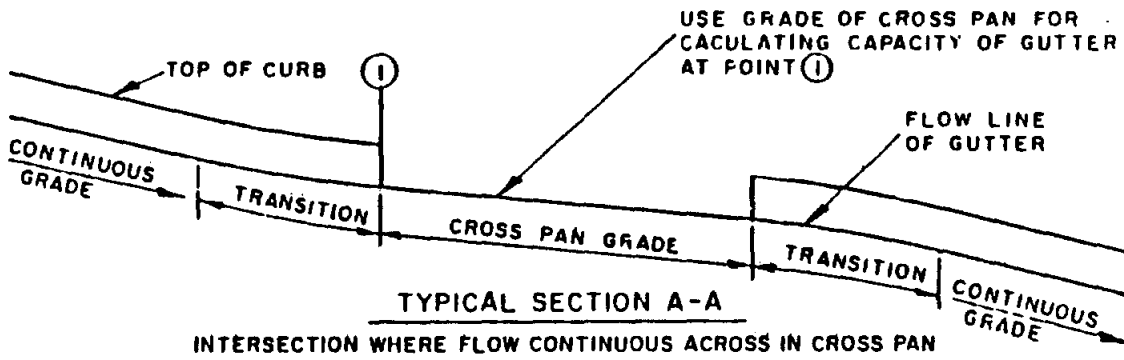
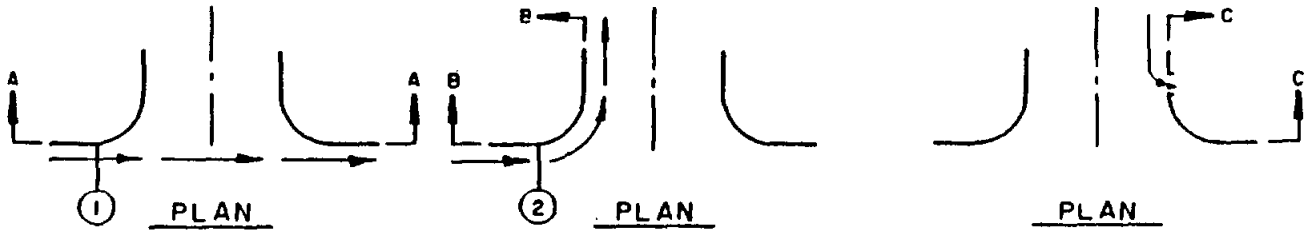

- B. Flow Approaching Streets Other Than Arterial. When the direction of flow is towards a non-arterial street, the allowable carrying capacity shall be calculated by applying the reduction factor from Figure 3-2 to the theoretical gutter capacity. The slope used to determine the reduction factor shall be the same effective slope used to calculate the theoretical capacity.

3.42 Gutter Capacity, Major Storm

3.42.1 Allowable Depth and Inundated Area. The allowable depth and inundated area for the major storm shall be limited as set forth in Table 3-2.

3.42.2 Theoretical Capacity. The theoretical carrying capacity of each gutter approaching an intersection shall be calculated, based upon the most critical cross section. The grade used for calculating capacity shall be based on guidelines presented in Section 3.41.

3.42.3 Allowable Capacity. The allowable capacity for gutters approaching an intersection shall be calculated by applying the reduction factor from Figure 3-2 to the theoretical capacity. The gutter grade used to determine the reduction factor shall be the same effective grade used to calculate the theoretical capacity.

3.43 Ponding

3.43.1 Initial Storm. The allowable pavement encroachment for the initial storm shall be as presented in Table 3-1.

3.43.2 Major Storm. The allowable depth and inundated area for the major storm shall be as presented in Table 3-2.

3.44 Cross Street Flow

3.44.1 Depth. Cross street flow depth at intersections shall be limited as set forth in Table 3-3.

3.44.2 Theoretical Capacity. The theoretical capacity shall be calculated at the critical point of the cross street flow. Where cross street flow will be conveyed across a local or collector street, the cross-sectional area used for calculations shall be along the centerline of the local street. The slope shall be the slope of the cross pan at the point.

SECTION 4 - INLETS

4.10 GENERAL

The primary purpose of a storm drain inlet is to intercept excess surface runoff and deposit it in a drainage system, thereby reducing the possibility of surface flooding.

The most common location for inlets is in streets that collect and channelize surface flow, making it convenient to intercept. Because the primary purpose of streets is to carry vehicular traffic, inlets must be designed so as not to conflict with that purpose.

The following guidelines shall be used in the design of inlets located in streets:

1. Minimum transition for depressed inlets shall be 10 feet.
2. The use of inlets with a 5" depression is discouraged on collector, industrial and arterial streets unless the inlet is recessed.
3. When recessed inlets are used, they shall not interfere with the intended use of the sidewalk.
4. The capacity of a recessed inlet on grade shall be calculated as 0.75 of the capacity of a similar unrecessed inlet.
5. Design and location of inlets shall take into consideration pedestrian and bicycle traffic.
6. Inlet design and location must be compatible with the criteria established in Section 3 of this manual.

4.20 CLASSIFICATION

Inlets are classified into three major groups: inlets in sumps, inlets on grade without gutter depression, and inlets on grade with gutter depression. Each of the three major classes includes several varieties, which are outlined here because of their wide use.

Inlets in Sumps

1. Curb Opening
2. Grate
3. Combination (Grate and Curb Opening)
4. Drop
5. Drop (Grate Covering)

Inlets on Grade without Gutter Depression

1. Curb Opening
2. Grate
3. Combination (Grate and Curb Opening)

Inlets on Grade with Gutter Depression

1. Curb Opening
2. Grate
3. Combination (Grate and Curb Opening)

Figure 4-1 shows typical inlet types, and Figures 4-2 through 4-8 show specific inlet types (see pages 4-8 through 4-14).

4.30 INLETS IN SUMPS

Inlets in sumps are inlets in low points of surface drainage to relieve ponding. Inlets with a 5" depression located in streets of less than one percent grade shall be considered inlets in sumps. The capacity of inlets in sumps must be known in order to determine the depth and width of ponding for a given discharge. The charts in this section may be used in the design of any inlet in a sump, regardless of its depth of depression.

4.31 Curb Opening Inlets and Drop Inlets

Unsubmerged curb opening inlets and drop inlets in a sump or low point are considered to function as rectangular weirs with a coefficient of discharge of 3.0. Their capacity shall be based on the following equation:

$$Q = 3.0(y)^{3/2} L$$

where:

Q = Capacity of curb opening inlet or capacity of drop inlet in cfs.

y = Head at the inlet in ft.

L = Length of opening for water to enter inlet in ft.

Figure 4-9 provides for direct solution of the above equation.

Curb opening inlets and drop inlets in sumps have a tendency to collect debris at their entrances. For this reason, the calculated inlet capacity shall be reduced by 10 percent to allow for clogging.

FIGURE 4-1

INLET TYPES

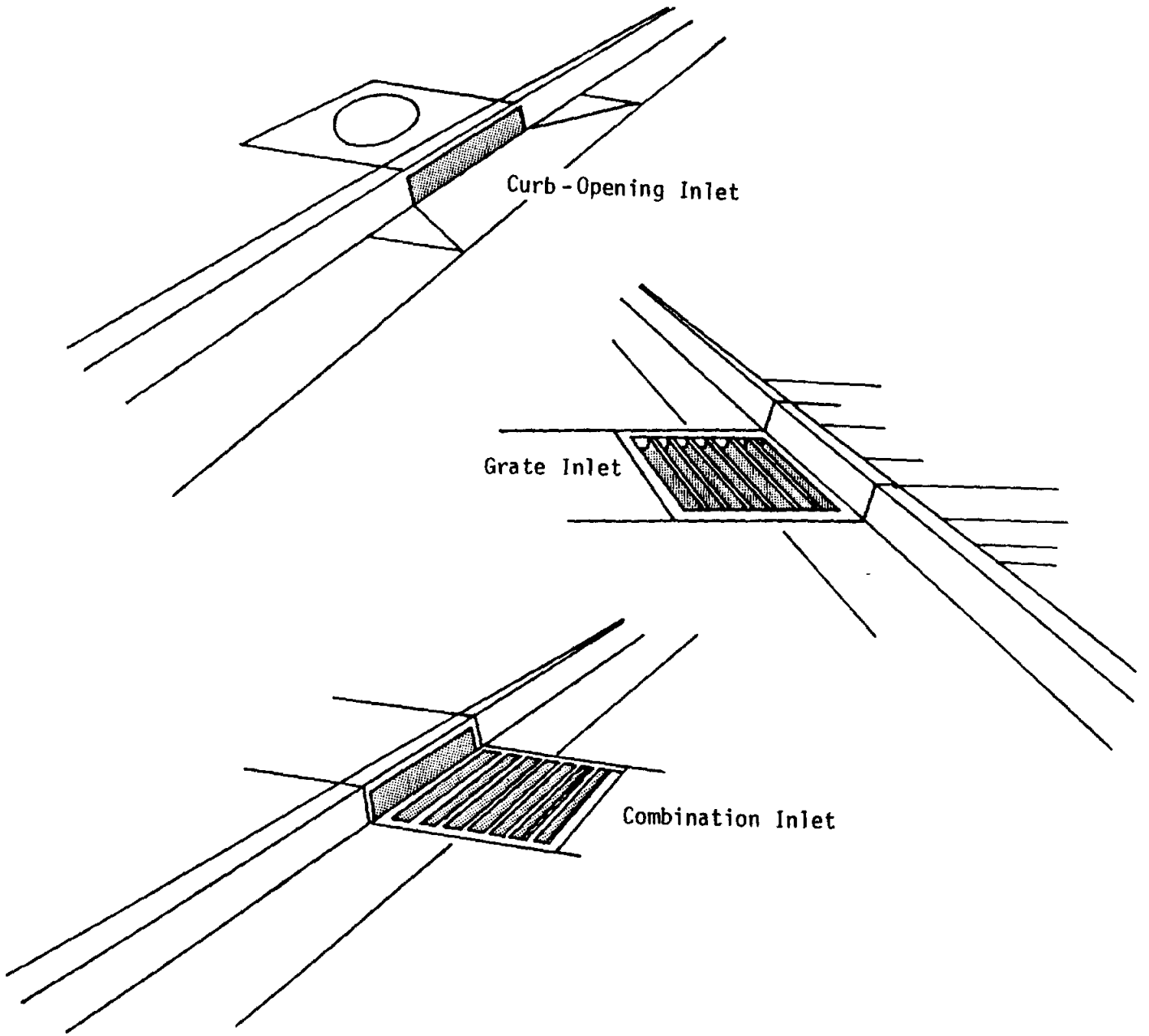

4.32 Grate Inlets

A grate inlet in a sump can be considered an orifice with a coefficient of discharge of 0.60. The capacity shall be based on the following equation:

$$Q = 4.82 A_g(y)^{1/2}$$

where:

Q = Capacity in cfs.

A_g = Area of clear opening in sq. ft.

y = Depth of flow at inlet or head at sump in ft.

The curve shown in Figure 4-10 provides for direct solution of the above equation.

Grate inlets in sumps have a tendency to clog when flows carry debris such as leaves and papers. For this reason, the calculated inlet capacity of a grate inlet shall be reduced by 25 percent to allow for clogging.

4.33 Combination Inlets

The capacity of a combination inlet consisting of a grate and curb opening inlet in a sump shall be considered to be the sum of the capacities obtained from Figures 4-9 and 4-10. When the capacity of the gutter is not exceeded, the grate inlet accepts the major portion of the flow. Under severe flooding conditions, however, the curb inlet will accept most of the flow since its capacity varies with $y^{1.5}$ whereas the capacity of a grate inlet varies as $y^{0.5}$.

Combination inlets in sumps have a tendency to clog and collect debris at their entrances. For this reason, the calculated inlet capacity shall be reduced by 20 percent to allow for this clogging.

4.40 INLETS ON GRADE WITHOUT GUTTER DEPRESSION

4.41 Curb Opening Inlets

The capacity of a curb inlet, like any weir, depends upon the head and length of overfall. In the case of any undepressed curb opening inlet, the head at the upstream end of the opening is the depth of flow in the gutter. In streets where grades are greater than 1 percent, the velocities are high and the depths of flow are usually small as there is little time to develop cross flow into the curb openings; therefore, undepressed inlets are inefficient when used in streets of appreciable

slope, but may be used satisfactorily where the grade is low and the crown slope high or the gutter channelized. Undepressed inlets do not interfere with traffic and usually are not susceptible to clogging. Inlets on grade should be designed and spaced so that 5 to 15 percent of gutter flow reaching each inlet will carry over to the next inlet downstream, provided the carryover is not objectionable to pedestrian or vehicular traffic.

The capacity of an undepressed inlet shall be determined by use of Figures 4-11 and 4-12, obtained from the Texas Department of Highways and Public Transportation (Ref. 7). An example problem using these figures is included at the end of this section.

4.42 Grate Inlets On Grade

Undepressed grate inlets on grade have a greater hydraulic capacity than curb inlets of the same length so long as they remain unclogged. Undepressed grate inlets on grade are inefficient in comparison to grate inlets in sumps. Their capacity shall be the capacity determined from Figure 4-11 reduced by 15 percent. Grate inlets should be so designed and spaced so that 5 to 15 percent of the gutter flow reaching each inlet will carry over to the next downstream inlet, provided the carryover is not objectionable to pedestrian or vehicular traffic.

Grates with bars parallel to the curb should always be used for the above described installations because transverse framing bars create splash which causes the water to jump or ride over the grate. Grates used shall be certified by the manufacturer as bicycle-safe. For flows on streets with grades less than one percent, little or no splashing occurs regardless of the direction of bars.

The calculated capacity for a grate inlet shall be reduced by 25 percent to allow for clogging.

4.43 Combination Inlets On Grade

Undepressed combination (curb opening and grate) inlets on grade have greater hydraulic capacity than curb or grate inlets of the same length. In general, combination inlets are the most efficient of the three types of undepressed inlets presented in this manual. Grates with bars parallel to the curb should always be used. The difference between a combination inlet and a grate inlet is that the curb opening receives the carryover flow that falls between the curb and the grate.

The capacity of a combination inlet shall be considered to be 90 percent of the sum of the capacities as determined for a curb opening inlet and a grate inlet (allowing for reduction due to clogging).

4.50 INLETS ON GRADE WITH GUTTER DEPRESSION

4.51 Curb Opening Inlets On Grade

The depression of the gutter at a curb opening inlet below the normal level of the gutter increases the cross flow toward the opening, thereby increasing the inlet capacity. Also, the downstream transition out of the depression causes backwater which further increases the amount of water captured. Depressed inlets should be used on continuous grades that exceed one percent, and their use in traffic lanes shall conform with requirements of Section 3 of this manual.

The depression depth, width, length and shape all have significant effects on the capacity of an inlet. Reference to Section 3 of this manual must be made for permissible gutter depressions.

The capacity of a depressed curb inlet will be determined by use of Figures 4-11 and 4-12.

4.52 Grate Inlets On Grade

The depression of the gutter at a grate inlet decreases the flow past the outside of a grate. The effect is the same as that when a curb inlet is depressed, namely the cross slope of the street directs the outer portion of flow toward the grate.

The bar arrangements for depressed grate inlets on streets with grades greater than one percent greatly affect the efficiency of the inlet. Grates with longitudinal bars eliminate splash that causes the water to jump and ride over the crossbar grates, and it is recommended that grates have a minimum of transverse or crossbars for strength and spacing only.

For low flows or for streets with grades less than one percent, little or no splashing occurs regardless of the direction of bars. However, as the flow or street grade increases, the grate with longitudinal bars becomes progressively superior to the crossbar grate. A few small rounded crossbars, installed at the bottom of the longitudinal bars as stiffeners or a safety stop for bicycle wheels, do not materially affect the hydraulic capacity of longitudinal bar grates.

The capacity of a grate inlet on grades less than one percent shall be the capacity determined from Figure 4-11. The capacity of grate inlets on grades greater than one percent shall be 90 percent of the capacity determined from Figure 4-11.

Grate inlets in depressions have a tendency to clog when gutter flows carry debris such as leaves and papers. For this reason the calculated inlet capacity of a grate inlet shall be reduced by 25 percent to allow for clogging.

4.53 Combination Inlets On Grade

Depressed combination inlets (curb opening plus grate) have greater hydraulic capacity than curb opening inlets or grate inlets of the same length. Generally speaking, combination inlets are the most efficient of the three types of depressed inlets presented in this manual. Grates with bars parallel to the curb should always be used for maximum efficiency. The basic difference between a combination inlet and a grate inlet is that the curb opening receives the carryover flow that passes the curb and the grate.

The depression depth, width, length and shape all have a significant effect on the capacity of an inlet. Reference to Section 3 of this manual must be made for permissible gutter depressions.

The capacity of a combination inlet shall be considered to be 90 percent of the sum of the capacity of a curb opening inlet and a grate inlet (allowing for reduction due to clogging).

FIGURE 4-2

DEPRESSED CURB-OPENING INLET

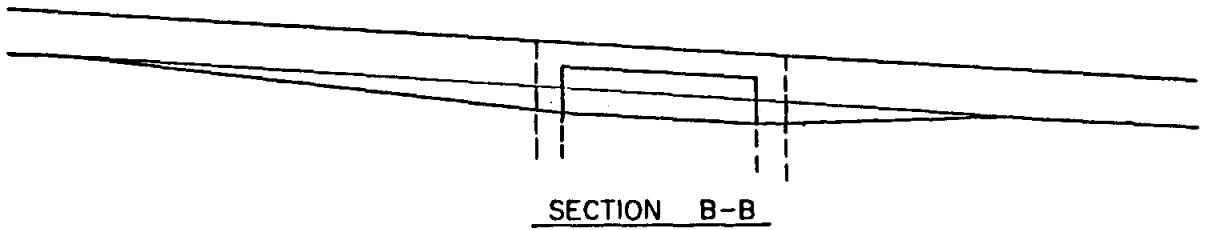
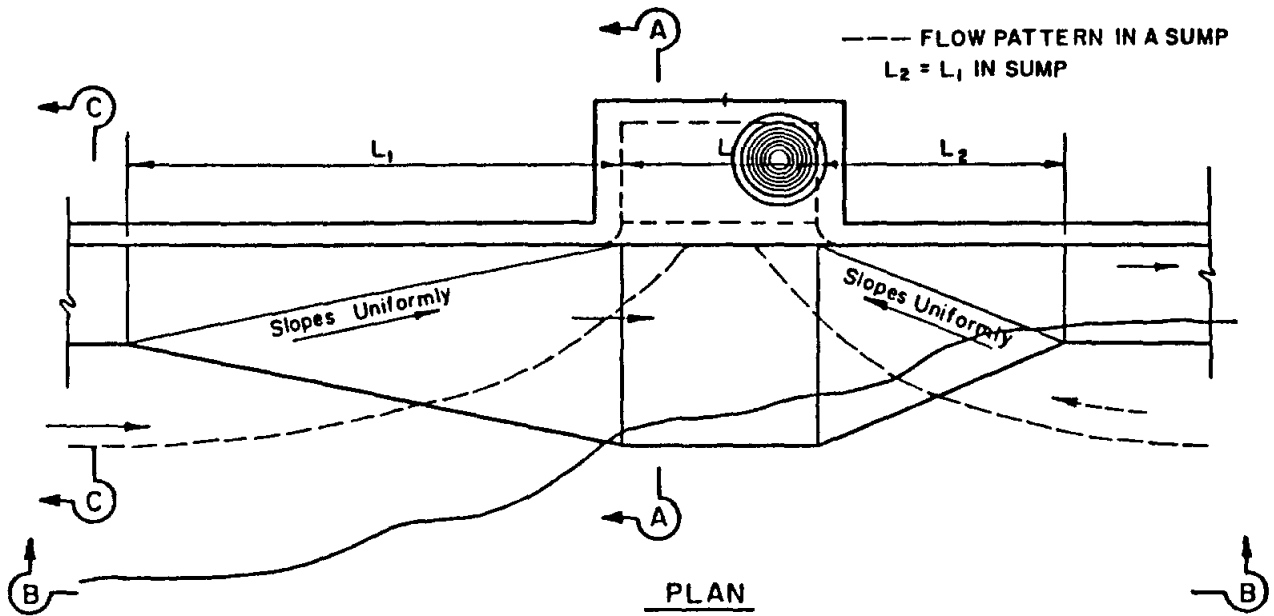

$$E = y_0 + \frac{v_0^2}{2g} + a$$

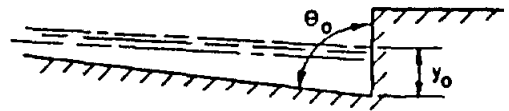
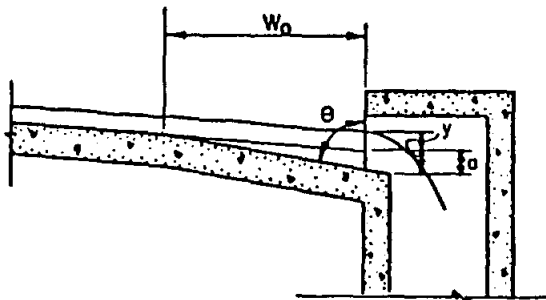
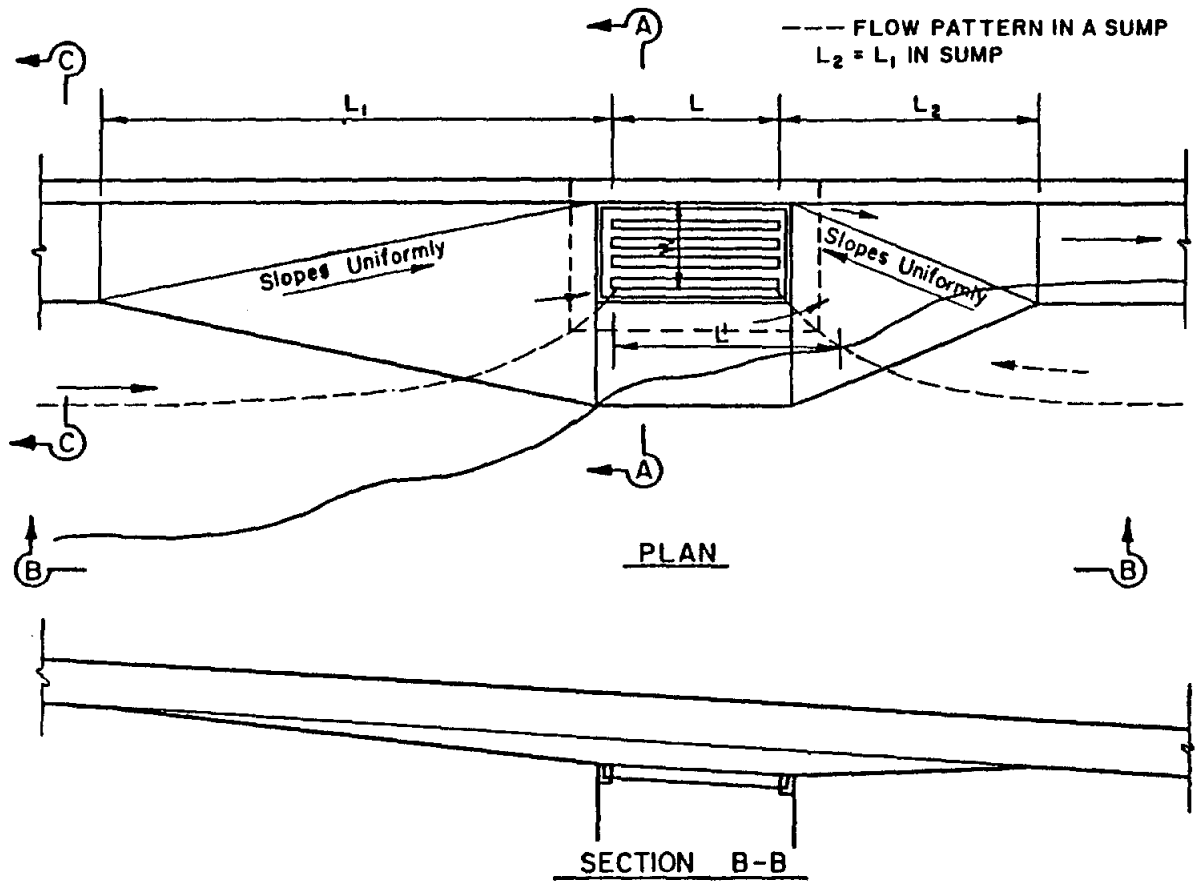

FIGURE 4-3

DEPRESSED GRATE INLET



$$E = y_0 + \frac{v_0^2}{2g} + a$$

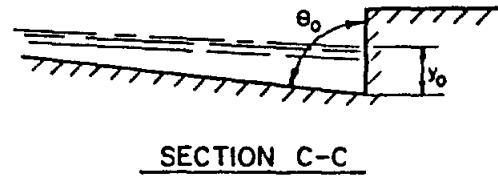
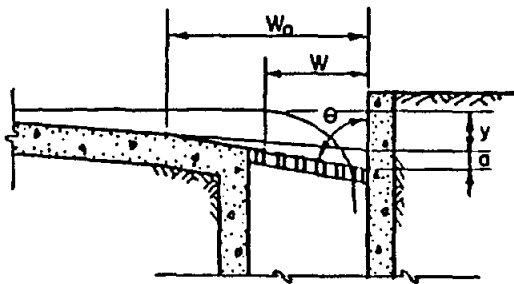
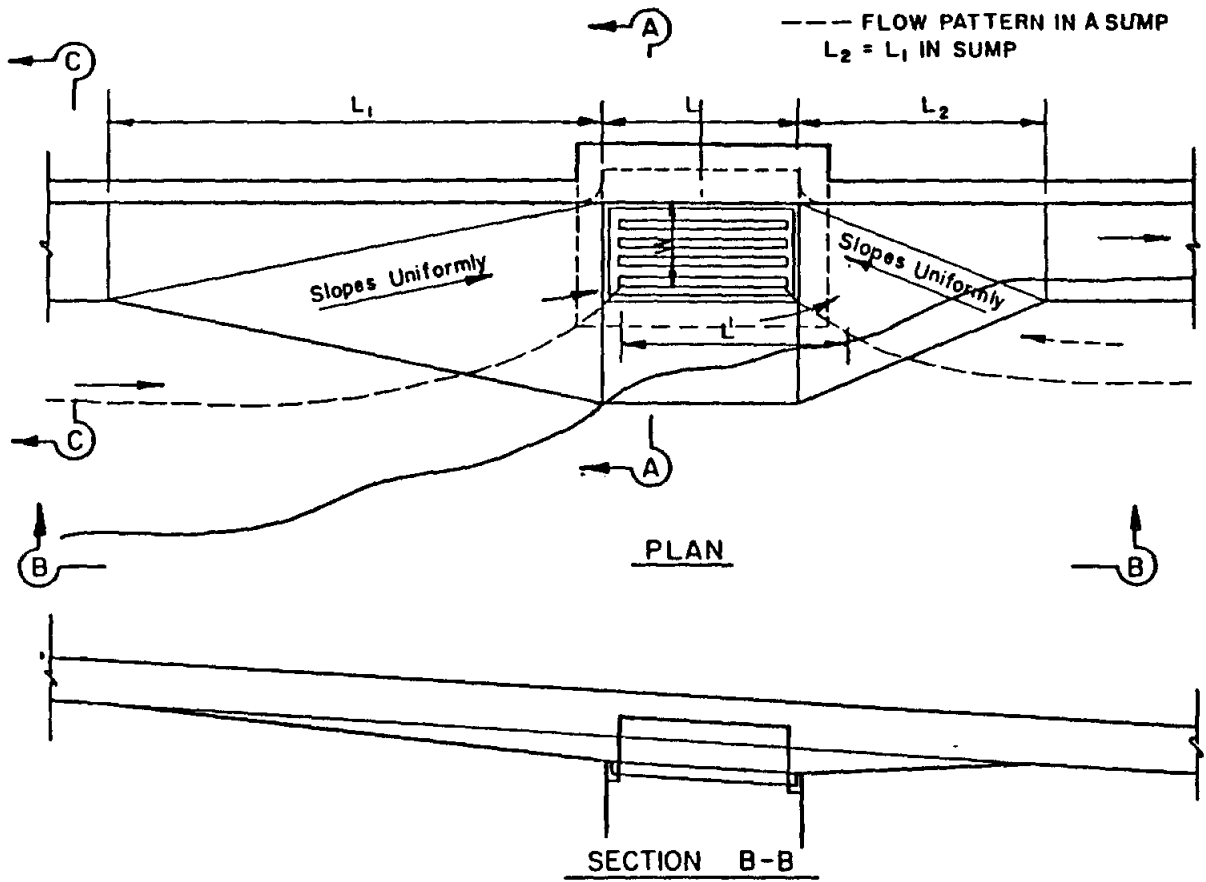

FIGURE 4-4

DEPRESSED COMBINATION INLET



$$E = y + \frac{v_0^2}{2g} + a$$

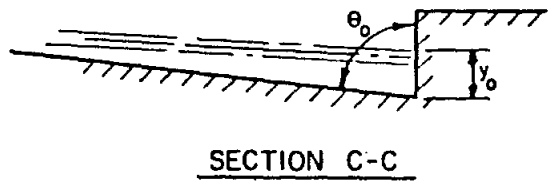
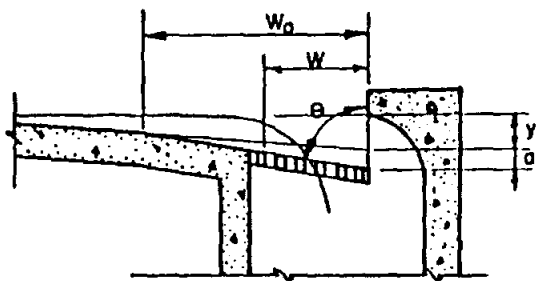
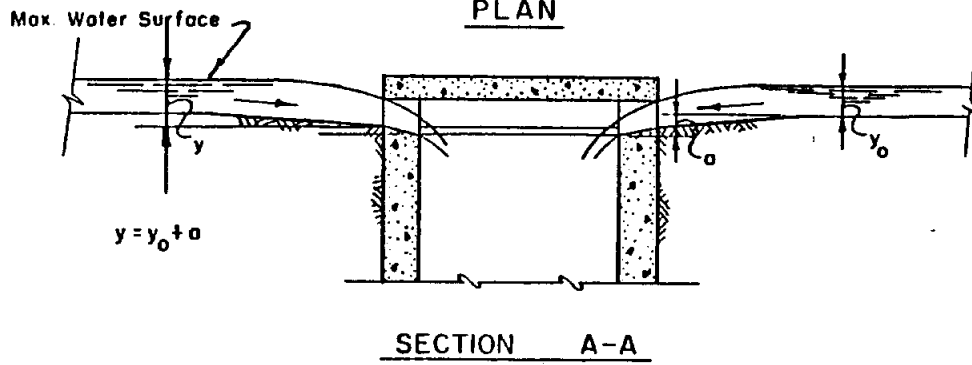
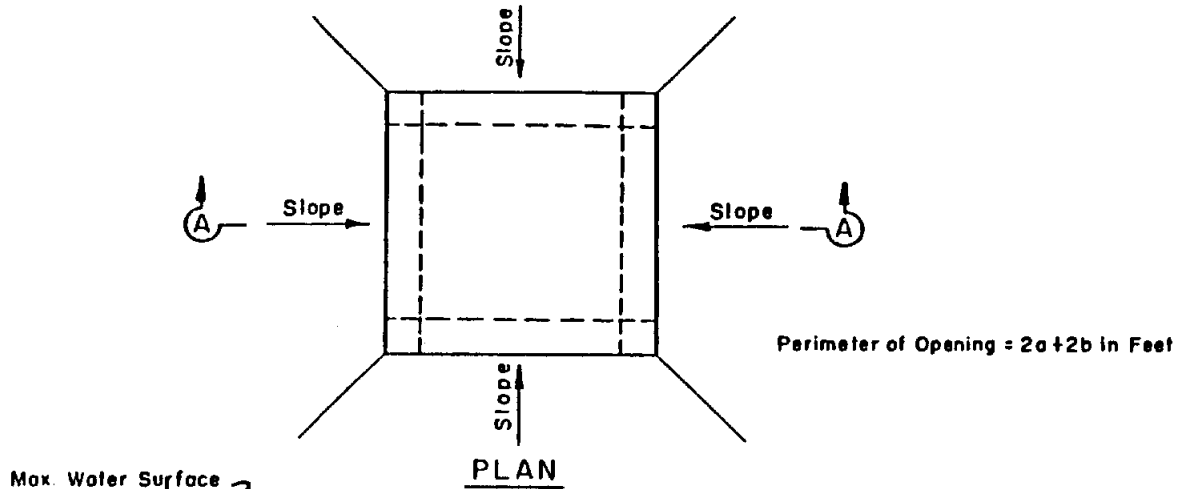

FIGURE 4-5

DROP INLET
(Grate covering)



DROP INLET
TYPE A-4

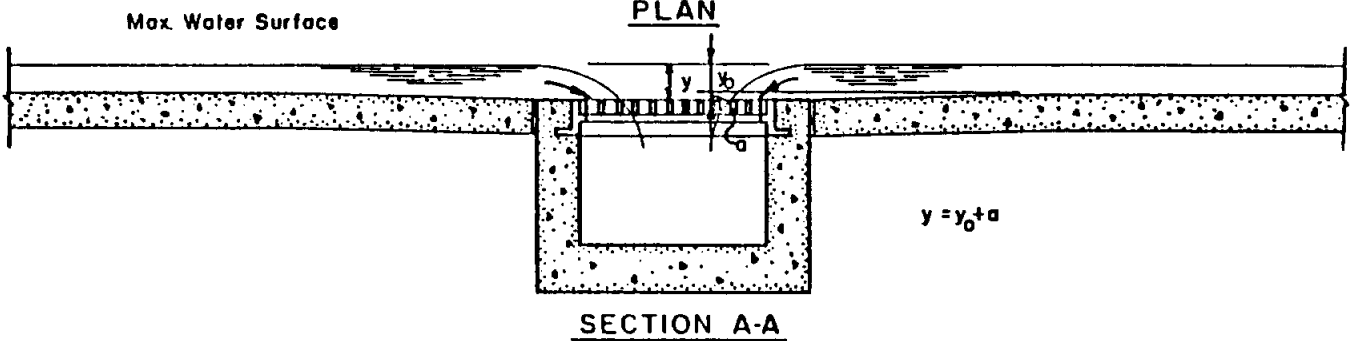
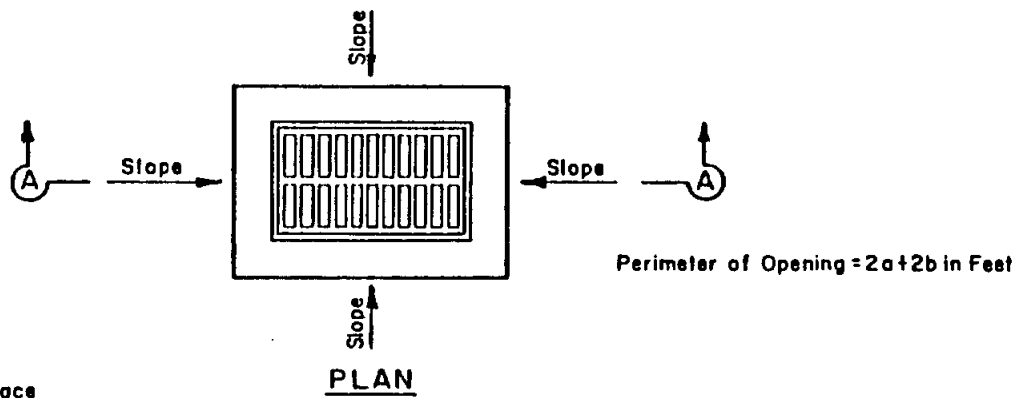
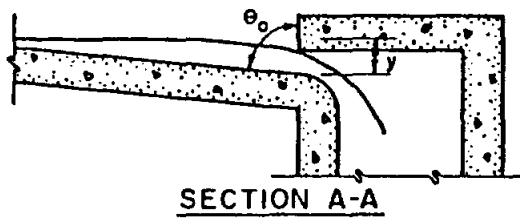
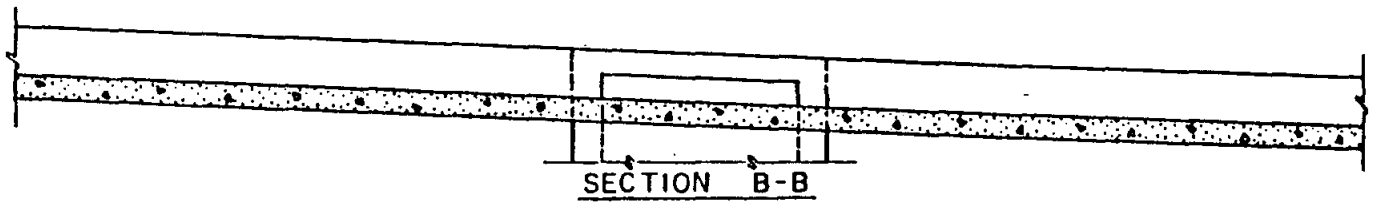
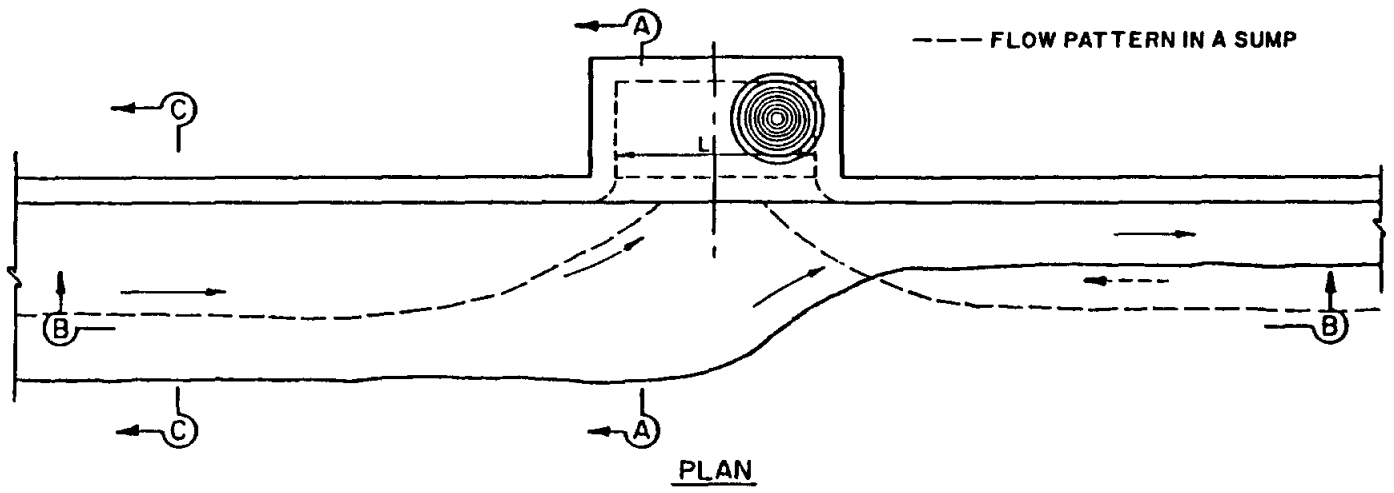

FIGURE 4-6

UNDEPRESSED CURB-OPENING (RECESSED)



$y = y_0$

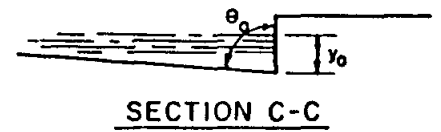

FIGURE 4-7
UNDEPRESSED GRATE INLET

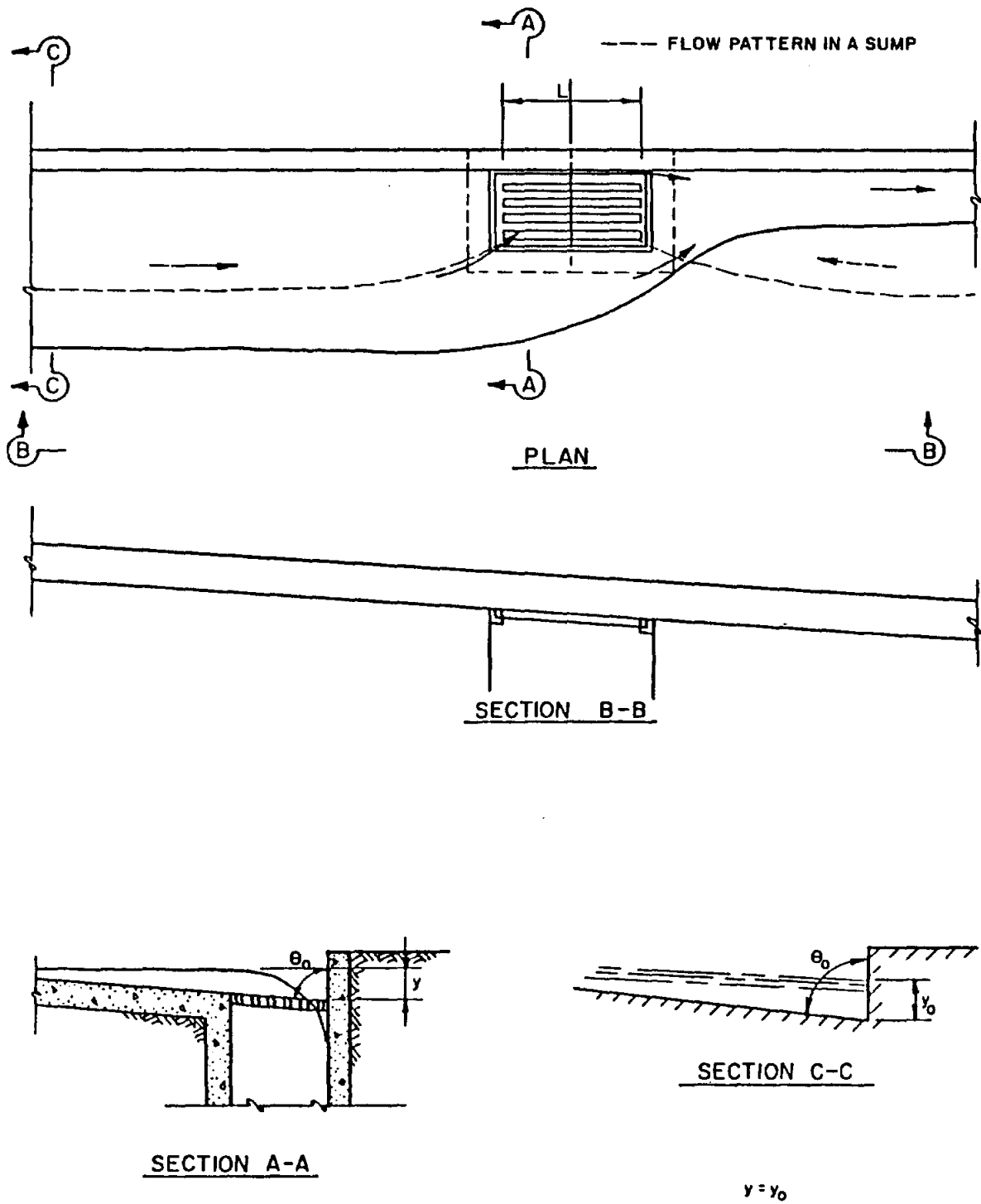

FIGURE 4-8
UNDEPRESSED COMBINATION INLET (RECESSED)

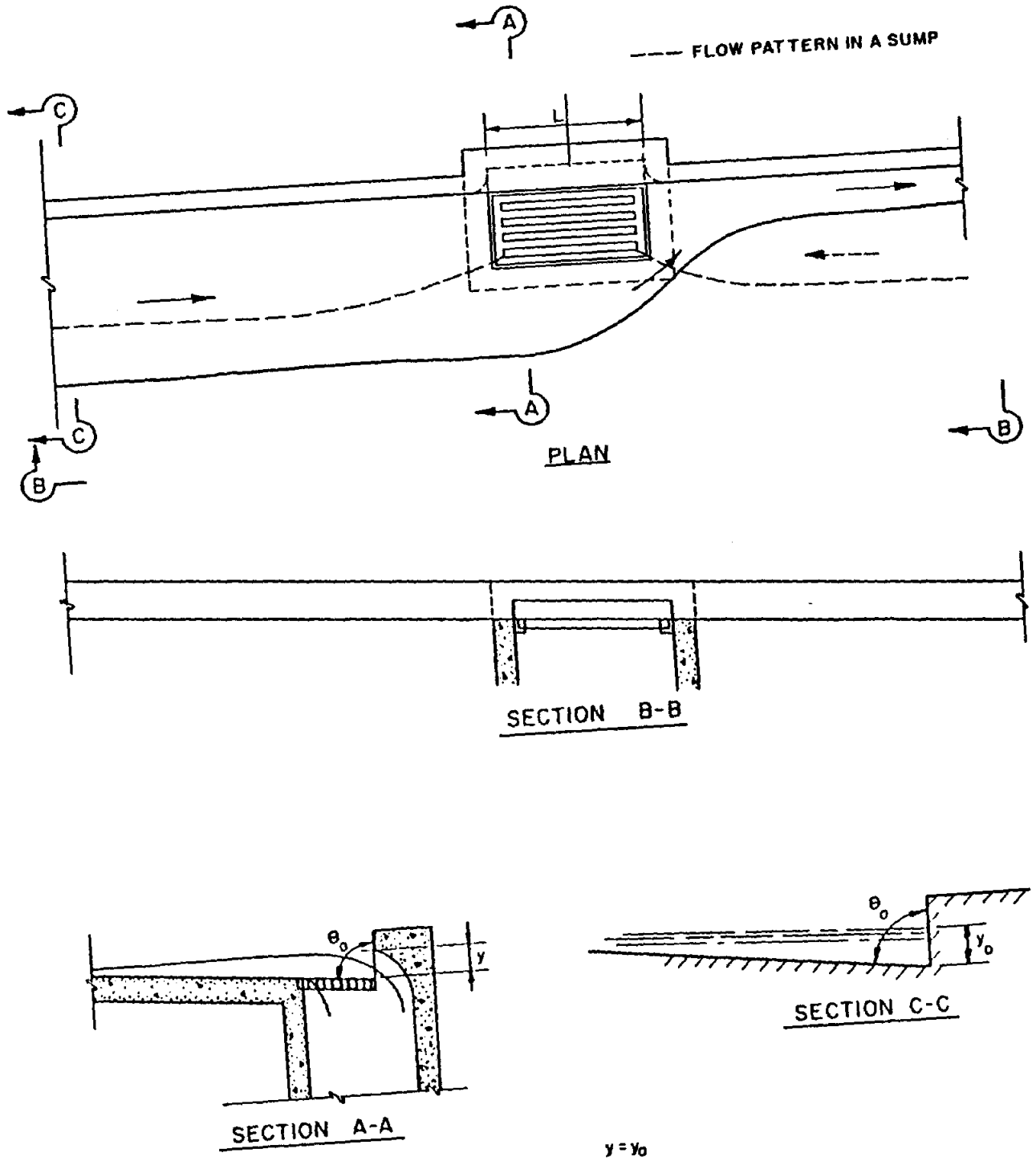

FIGURE 4-9

CAPACITY OF UNSUBMERGED CURB OPENING INLETS AND DROP INLETS

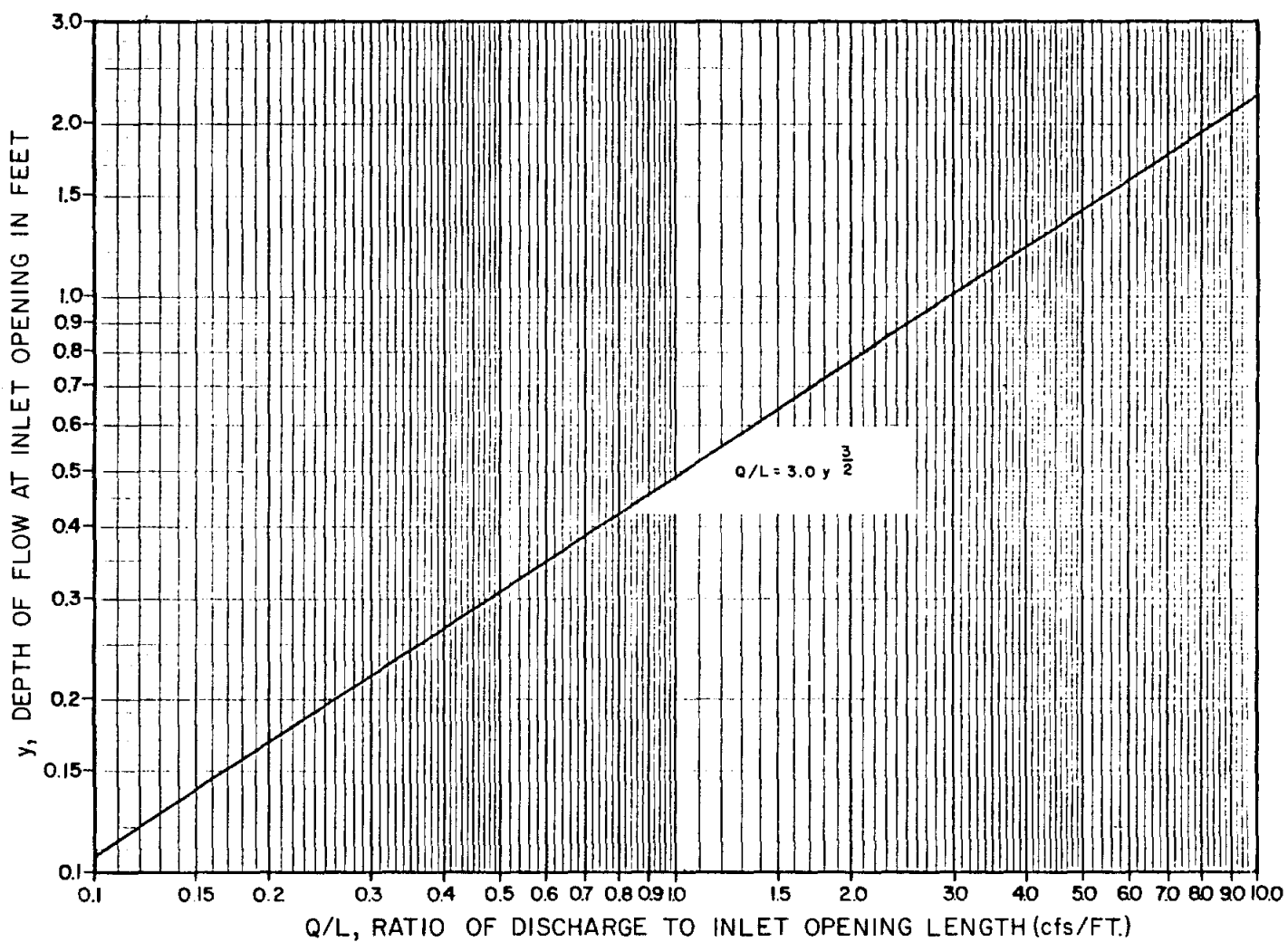

FIGURE 4-10

CAPACITY OF GRATE INLETS

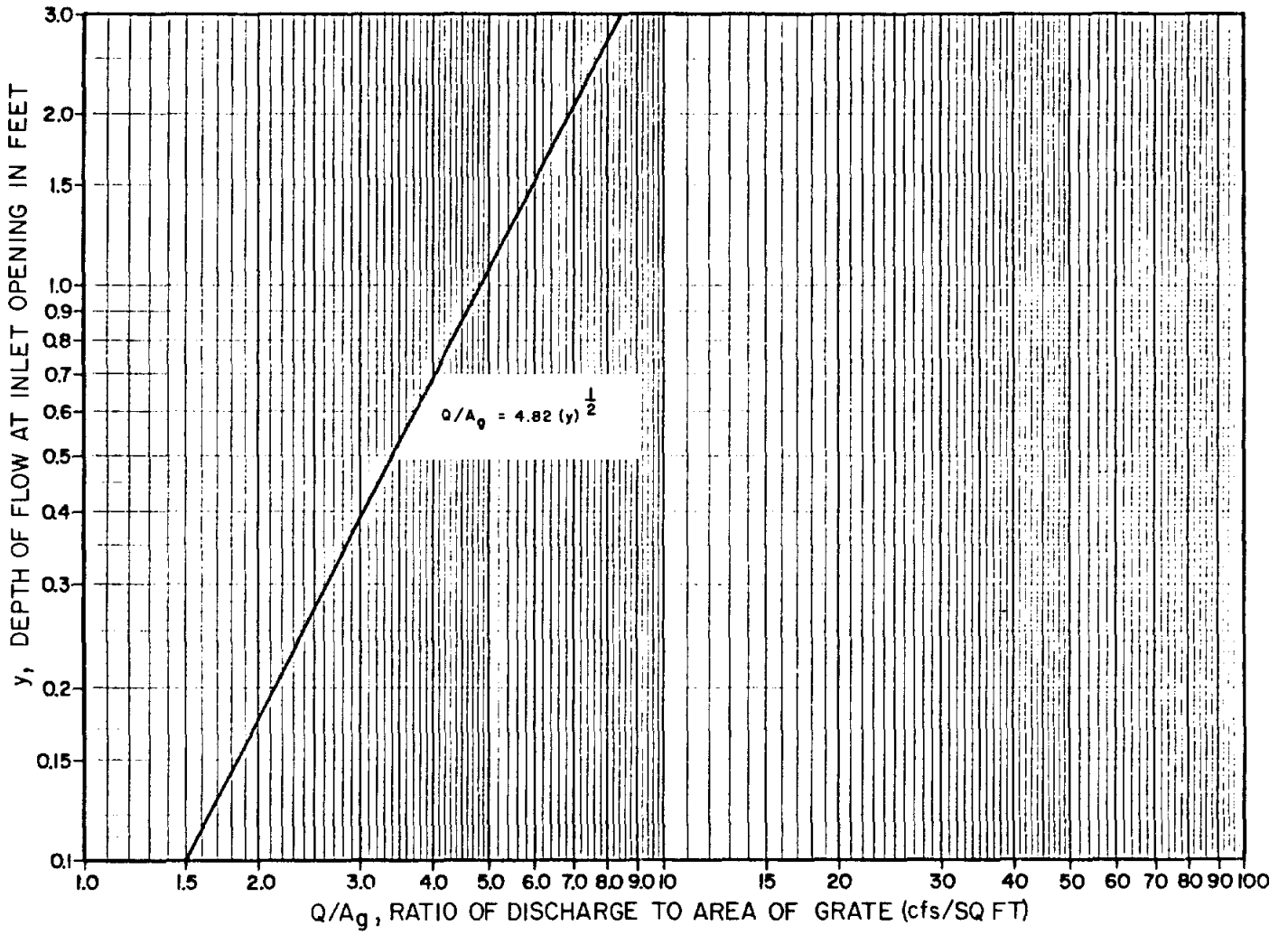

FIGURE 4-11
CAPACITY FOR INLETS ON GRADE

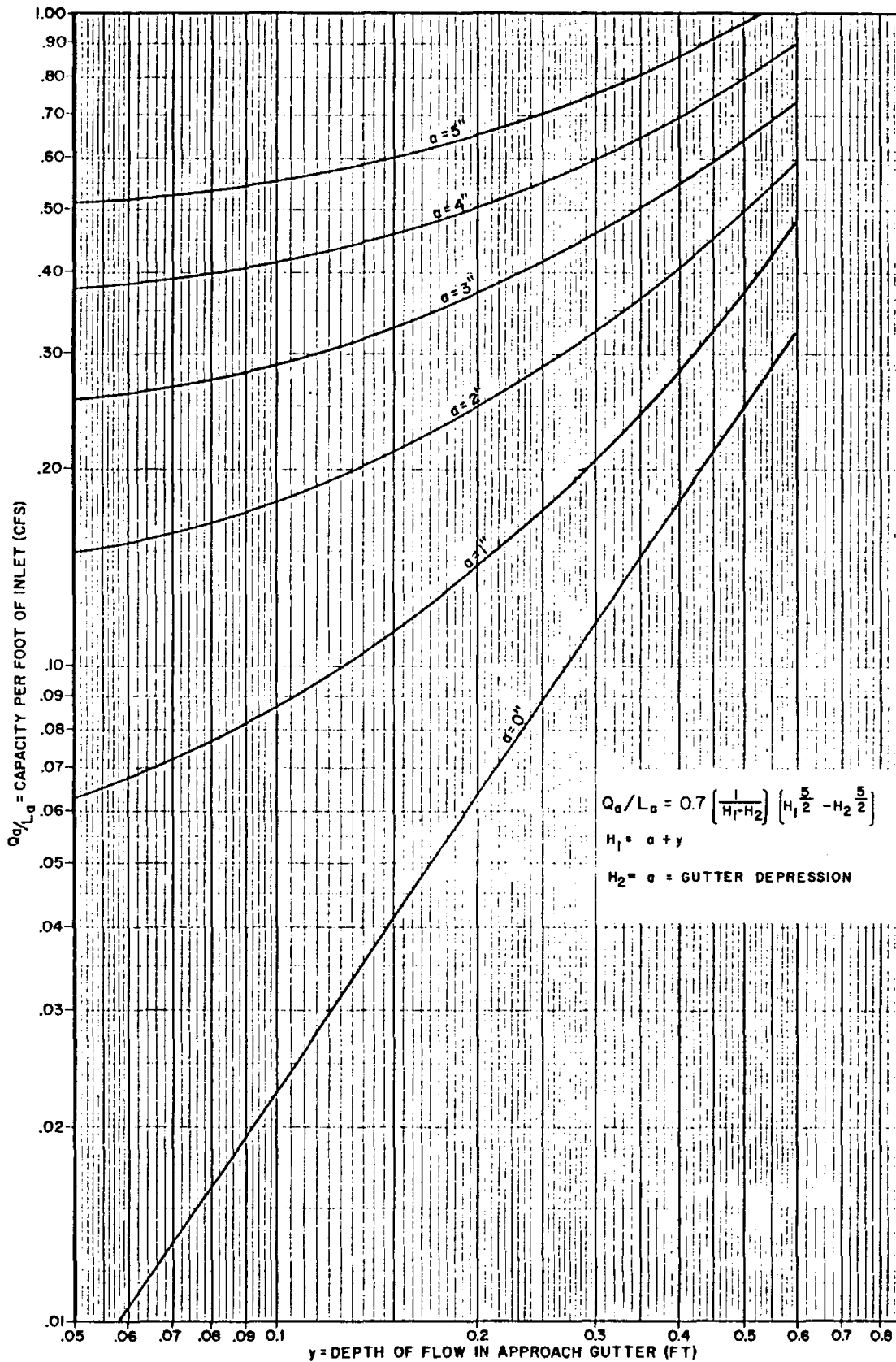
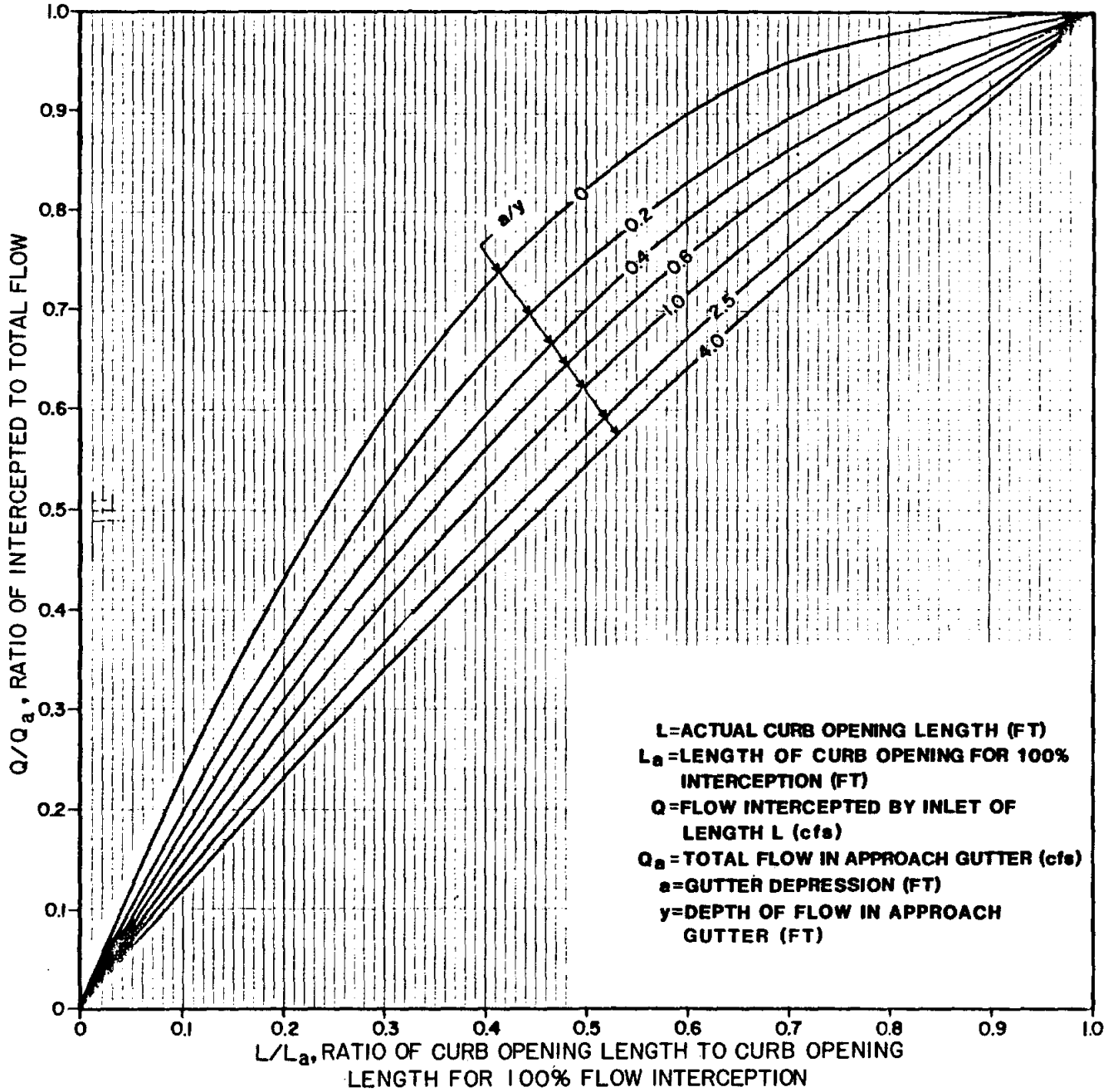

FIGURE 4-12

CURVES TO DETERMINE RATIO OF INTERCEPTED TO TOTAL FLOW FOR INLETS ON GRADE



4.60 Use of Figures 4-11 and 4-12

EXAMPLE 1

Given: Street Width = 30'
Cross Slope = 0'
Street Grade = 1.0%
 Q_a in one gutter = 8 cfs

Determine: Capacity, Q , of a 10' curb inlet with 2.5" depression.

Step 1. From Figure 3-1 (Section 3) assuming $z = 3$ and $n = 0.016$, depth of flow in gutter is $y = 4.6''$, or $0.38'$.

Step 2. Enter Fig. 4-11 with $y = 0.38'$ and $a = 2.5''$ and find corresponding $\frac{Q_a}{L_a} = 0.46$.

Step 3. Compute $L_a = \frac{8}{0.46} = 17.4$.

Step 4. Compute $\frac{L}{L_a} = \frac{10}{17.4} = 0.57$.

Step 5. Enter Figure 4-12 with $\frac{L}{L_a} = 0.57$ and $\frac{a}{y} = 0.55$ and find corresponding $\frac{Q}{Q_a} = 0.74$.

Step 6. Determine Q from $\frac{Q}{Q_a} = 0.74$.

$$Q = 0.74 \times 8 = 5.9 \text{ cfs}$$

EXAMPLE 2

Given: Street Width = 44'
Cross Slope = 0'
Street Grade = 0.6%
 Q_a in low gutter = 8 cfs

Determine: Length, L , of undepressed curb inlet required to intercept 80% of gutter flow ($Q = 6.4$ cfs).

Step 1. From Figure 3-1 (Section 3) assuming $z = 44$ and $n = 0.016$, depth of flow in gutter (y) = 4.32", or 0.36'.

Step 2. Entering Figure 4-11 with $y = 0.36$ and $a = 0$, find corresponding $\frac{Q_a}{L_a} = 0.155$.

Step 3. Determine $L_a = \frac{8}{0.155} = 51.6$.

Step 4. Entering Figure 4-12 with $\frac{Q}{Q_a} = 0.8$ and $\frac{a}{y} = 0$, find corresponding $\frac{L}{L_a} = 0.48$.

Step 5. Compute L from $\frac{L}{L_a} = 0.48$. $L = 51.6 (0.48) = 24.8'$. Use $L = 25$.

The following three steps will confirm this value of L . Use $L = 25$.

Step 6. Compute $\frac{L}{L_a} = \frac{25}{51.6} = 0.485$.

Step 7. Entering Figure 4-12 with $\frac{L}{L_a} = 0.485$ and $\frac{a}{y} = 0$, find corresponding $\frac{Q}{Q_a} = 0.81$.

Step 8. Compute Q from $\frac{Q}{Q_a} = 0.81$. $Q = 8(0.81) = 6.5$ cfs.

SECTION 5 - STORM DRAINS

5.10 GENERAL

A general description of storm drainage systems and quantities of storm runoff is presented in Section 2 of this manual. It is the purpose of this section to consider the significance of the hydraulic elements of storm drains and their appurtenances to a storm drainage system.

Hydraulically, storm drainage systems are conduits (open or enclosed) in which unsteady and non-uniform free-surface flow exists. Storm drains accordingly are designed for open-channel flow to satisfy as well as possible the requirements for unsteady and non-uniform flow. Steady flow conditions may or may not be uniform.

5.20 VELOCITIES AND GRADES

5.21 Minimum Grades

Storm drains should operate with velocities of flow sufficient to prevent excessive deposition of solid material; otherwise, objectionable clogging may result. The controlling velocity is near the bottom of the conduit and considerably less than the mean velocity. Storm drains shall be designed to have a minimum mean velocity flowing full at 2.5 fps. Table 5-1 indicates the grades for both concrete pipe ($n = 0.012$) and for corrugated metal pipe ($n = 0.024$) to produce a velocity of 2.5 fps, which is considered to be the lower limit of scouring velocity. The minimum slope for standard construction procedures shall be 0.40% when possible. Any variance must have prior approval.

5.22 Maximum Velocities

Maximum velocities in conduits are important mainly because of the possibilities of excessive erosion on the storm drain inverts. Table 5-2 shows the limits of maximum velocity.

5.23 Minimum Diameter

Pipes that are to become an integral part of the public storm sewer system shall have a minimum diameter of 18 inches.

TABLE 5-1
 MINIMUM SLOPE REQUIRED
 TO PRODUCE SCOURING VELOCITY

<u>Pipe Size, in.</u>	<u>Concrete Pipe Slope, ft/ft</u>	<u>Corrugated Metal Pipe Slope, ft/ft</u>
18	0.0018	0.0060
21	0.0015	0.0049
24	0.0013	0.0041
27	0.0011	0.0035
30	0.0009	0.0031
36	0.0007	0.0024
42	0.0006	0.0020
48	0.0005	0.0016
54	0.0004	0.0014
60	0.0004	0.0012
66	0.0004	0.0011
72	0.0003	0.0010
78	0.0003	0.0009
84	0.0003	0.0008
96	0.0002	0.0007

TABLE 5-2
 MAXIMUM VELOCITY IN STORM DRAINS*

<u>Description</u>	<u>Maximum Permissible Velocity</u>
Culverts (all types)	15 fps
Storm Drains (inlet laterals)	No Limit
Storm Drains (collectors)	15 fps
Storm Drains (mains)	12 fps

*Reference 8.

TABLE 5-3
 ROUGHNESS COEFFICIENTS "n" FOR STORM DRAINS

<u>Materials of Construction</u>	<u>Design Coefficient</u>	<u>Range of Manning Coefficient</u>
Concrete Pipe	0.012	0.011 - 0.015
Corrugated Metal Pipe		
Plain or Coated	0.024	0.022 - 0.026
Paved Invert	0.020	0.018 - 0.022

5.30 MATERIALS

In selecting a roughness coefficient for concrete pipe, between 0.011 and 0.015, consideration will be given to the average conditions during the useful life of the structure. An "n" value of 0.017 for concrete pipe shall be used primarily in analyzing old conduits where alignment is poor and joints have become rough. If, for example, concrete pipe is designed for a location where it is considered suitable, and there is reason to believe that the roughness would increase through erosion or corrosion of the interior surface, slight displacement of joints, or entrance of foreign materials, a roughness coefficient will be selected which, in the judgement of the designer, will represent the average condition. Any selection of "n" values below the minimum or above the maximum for either monolithic concrete structures, concrete pipe or corrugated metal pipe, must have the written approval of the County Commissioners.

The coefficients of roughness listed in Table 5-3 are for use in the nomographs contained herein, or for direct solution of Manning's equation.

5.40 FULL OR PART FULL FLOW IN STORM DRAINS

5.41 General

All storm drains shall be designed by the application of the continuity equation and Manning's equation, which are shown respectively as:

$$Q = AV, \text{ and } Q = \frac{1.49}{n} AR^{2/3} S_f^{1/2}$$

where:

Q = Pipe flow in cfs.

A = Cross-sectional area of pipe in ft².

V = Velocity of flow in fps.

n = Coefficient of roughness of pipe.

R = Hydraulic radius = A/W_p in ft.

S_f = Friction slope in pipe in ft./ft.

W_p = Wetted perimeter in ft.

Charts and nomographs can be used instead of the direct solutions for the above equations.

There are several general rules to be observed when designing storm sewer systems. When followed, they will tend to alleviate or eliminate the common mistakes made in storm sewer design. These rules are:

1. Select pipe size and slope so that the velocity of flow will increase progressively, or at least will not appreciably decrease, at inlets, bends, or other changes in geometry or configuration.
2. Do not discharge the contents of a larger pipe into a smaller one, even though the capacity of the smaller pipe may be greater due to steeper slope.
3. At changes in pipe size, match the soffits of the two pipes at the same level rather than matching the flow lines.
4. Conduits are to be checked at the time of their design with reference to critical slope. If the slope of the line is greater than critical slope, the unit will likely be operating under entrance control instead of normal flow. Conduit slope should be kept below critical slope if at all possible. This also removes the possibility of hydraulic jump formation within the line.

5.42 Pipe Flow Charts

Figures 5-1 through 5-9 are nomographs published by the Texas Department of Highways and Public Transportation (Ref. 7) for determining flow properties in circular pipe, elliptical pipe, and pipe-arches. The nomographs are based upon an "n" value of 0.012 for concrete and 0.024 for corrugated metal.

For values of "n" other than 0.012, the value of Q should be modified to Q_c by using the formula:

$$Q_c = \frac{Q_n (0.012)}{n_c}$$

where n_c is the value of "n" other than 0.012 and Q_n is the flow from the nomograph based on $n = 0.012$. This formula is applied as follows: If $n_c = 0.015$, use the value of Q_n (based on $n = 0.012$) from the nomographs, and then multiply this by $0.012/n_c$, or $0.012/0.015$ in this case.

5.50 HYDRAULIC GRADIENT AND PROFILE OF STORM DRAIN

In storm drain systems flowing full, all losses of energy through resistance of flow in pipes, by changes of momentum or by interference with flow patterns at junctions, must be accounted for by the accumulated head losses along the system from its initial upstream inlet to its outlet. The purpose of accurate determinations of head losses at junctions is to

include these values in a progressive calculation of the hydraulic gradient along the storm drain system. In this way, it is possible to determine the water surface elevation that will exist at each structure.

Kleberg County does not require the hydraulic grade line to be established for all storm drainage design. It is not necessary to compute the hydraulic grade line of a conduit run if: (1) the slope and the pipe sizes are chosen so that the slope is equal to or greater than friction slope and less than critical slope, (2) the inside top surfaces rather than the flow lines of successive pipe are lined up at changes in size, and (3) the surface of the water at the point of discharge will not rise above the top of the outlet. Subject to these constraints, the pipe will not operate under pressure and the slope of the water surface under capacity discharge will approximately parallel the slope of the invert of the pipe.

Lacking these conditions or when it is desired to check the system against a larger flood than that used in sizing the pipes, and if the tailwater is known, then the hydraulic grade line and energy shall be computed and plotted. The friction head loss shall be determined by direct application of Manning's equation or by appropriate nomographs in this section. Minor losses due to turbulence at structures shall be determined by the procedure of Paragraph 5.80. The hydraulic grade line shall in no case be closer to the surface of the ground or street than 2 feet unless otherwise approved by the County Commissioners. If the storm sewer system is to be extended at some future date, present and future operations of the system must be considered.

5.60 MANHOLE LOCATION

Manholes shall be located at intervals not to exceed 600 feet for pipe 30 inches in diameter or smaller. Manholes shall preferably be located at street intersections, conduit junctions, changes of grade and changes of alignment.

Manholes for pipe greater than 30 inches in diameter shall be located at points where design indicates entrance into the conduit is desirable; however, in no case shall the distance between openings or entrances be greater than 1,200 feet.

5.70 PIPE CONNECTIONS

Prefabricated wye and tee connections are available up to and including 24" x 24". Connections larger than 24 inches will be made by field connections. This recommendation is based primarily on the fact that field connections are more easily fitted to given alignment than are precast connections. Regardless of the amount of care exercised by the Contractor in laying the pipe, gains in footage invariably throw precast connections slightly out of alignment. This error increases in magnitude as the size of pipe increases.

5.80 MINOR HEAD LOSSES AT STRUCTURES

The following total energy head losses at structures shall be determined for inlets, manholes, wye branches or bends in the design of closed conduits. See Figure 5-10 for details of each case. Minimum head loss used at any structure shall be 0.10 foot, unless otherwise approved.

The basic equation for most cases, where there is both upstream and downstream velocity, takes the form as set forth below with the various conditions of the coefficient K_j shown in Tables 5-4, 5-5, and 5-6:

$$h_j = \frac{V_2^2 - K_j V_1^2}{2g}$$

where:

h_j = Junction or structure head loss in ft.

V_1 = Velocity in upstream pipe in fps.

V_2 = Velocity in downstream pipe in fps.

K_j = Junction or structure coefficient of loss.

g = Acceleration of gravity, 32 ft/sec².

In the case where the upstream velocity is negligible, the equation for head loss becomes:

$$h_j = K_j \frac{V_2^2}{2g}$$

Short radius bends may be used on 24" and larger pipes when flow must undergo a direction change at a junction or bend. Reductions in head loss at manholes may be realized in this way. A manhole shall always be located at the end of such short radius bends.

TABLE 5-4
JUNCTION OR STRUCTURE
COEFFICIENT OF LOSS

<u>Case No.</u>	<u>Description of Condition (See Figure 5-10)</u>	<u>Coefficient K_j</u>
I	Inlet on Main Line*	0.50
II	Inlet on Main Line with Branch Lateral*	0.25
III	Manhole on Main Line with 45° Branch Lateral	0.50
IV	Manhole on Main Line with 90° Branch Lateral	0.25
V	45° Wye Connection or cut-in	0.75
VI	Inlet or Manhole at Beginning of Line	1.25
VII	Conduit on Curves for 90°** Curve radius = diameter Curve radius = 2 to 8 times diameter Curve radius = 8 to 20 times diameter	0.50 0.40 0.25
VIII	Bends where radius is equal to diameter 90° bend 60° bend 45° bend 22-1/2° bend	0.50 0.48 0.35 0.20
	Manhole on line with 60° Lateral	0.35
	Manhole on line with 22-1/2° Lateral	0.75

* Must be approved by Director of Engineering

** Where bends other than 90° are used, the 90° bend coefficient can be used with the following percentage factors applied:

60° Bend - 85%; 45° Bend - 70%; 22-1/2° Bend - 40%

The values of the coefficient "K_j" for determining the loss of head due to obstructions in pipes are shown in Table 5-5 and the coefficients are used in the following equation to calculate the head loss at the obstruction:

$$h_j = K_j \frac{V_2^2}{2g}$$

TABLE 5-5
HEAD LOSS COEFFICIENTS DUE TO OBSTRUCTIONS

$\frac{A}{A_o}^*$	K _j	$\frac{A}{A_o}^*$	K _j
1.05	0.10	3.0	15.0
1.1	0.21	4.0	27.3
1.2	0.50	5.0	42.0
1.4	1.15	6.0	57.0
1.6	2.40	7.0	72.5
1.8	4.00	8.0	88.0
2.0	5.55	9.0	104.0
2.2	7.05	10.00	121.0
2.5	9.70		

* $\frac{A}{A_o}$ = Ratio of area of pipe to area of opening at obstruction.

The values of coefficient "K_j" for determining the loss of head due to sudden enlargements and sudden contractions in pipes are shown in Table 5-6 and the coefficients are used in the following equation to calculate the head loss at the change in section:

$$h_j = K_j \frac{V^2}{2g}, \text{ where } V = \text{velocity in smaller pipe.}$$

TABLE 5-6
HEAD LOSS COEFFICIENTS DUE TO SUDDEN
ENLARGEMENTS AND CONTRACTIONS

$\frac{D_2}{D_1}$ *	Sudden Enlargements, K _j	Sudden Contractions, K _j
1.2	0.10	0.08
1.4	0.23	0.18
1.6	0.35	0.25
1.8	0.44	0.33
2.0	0.52	0.36
2.5	0.65	0.40
3.0	0.72	0.42
4.0	0.80	0.44
5.0	0.84	0.45
10.0	0.89	0.46
	0.91	0.47

* $\frac{D_2}{D_1}$ = Ratio of larger to smaller diameter

5.90 UTILITIES

In the design of a storm drainage system, the engineer is frequently confronted with the problem of grade conflict between the proposed storm drain and existing utilities such as water, gas and sanitary sewer lines.

When conflicts arise between a proposed drainage system and a utility system, the owner of the utility system shall be contacted and made aware of the conflict. Any adjustments necessary to either the drainage system or the utility can then be determined.

FIGURE 5-1

UNIFORM FLOW FOR PIPE CULVERTS

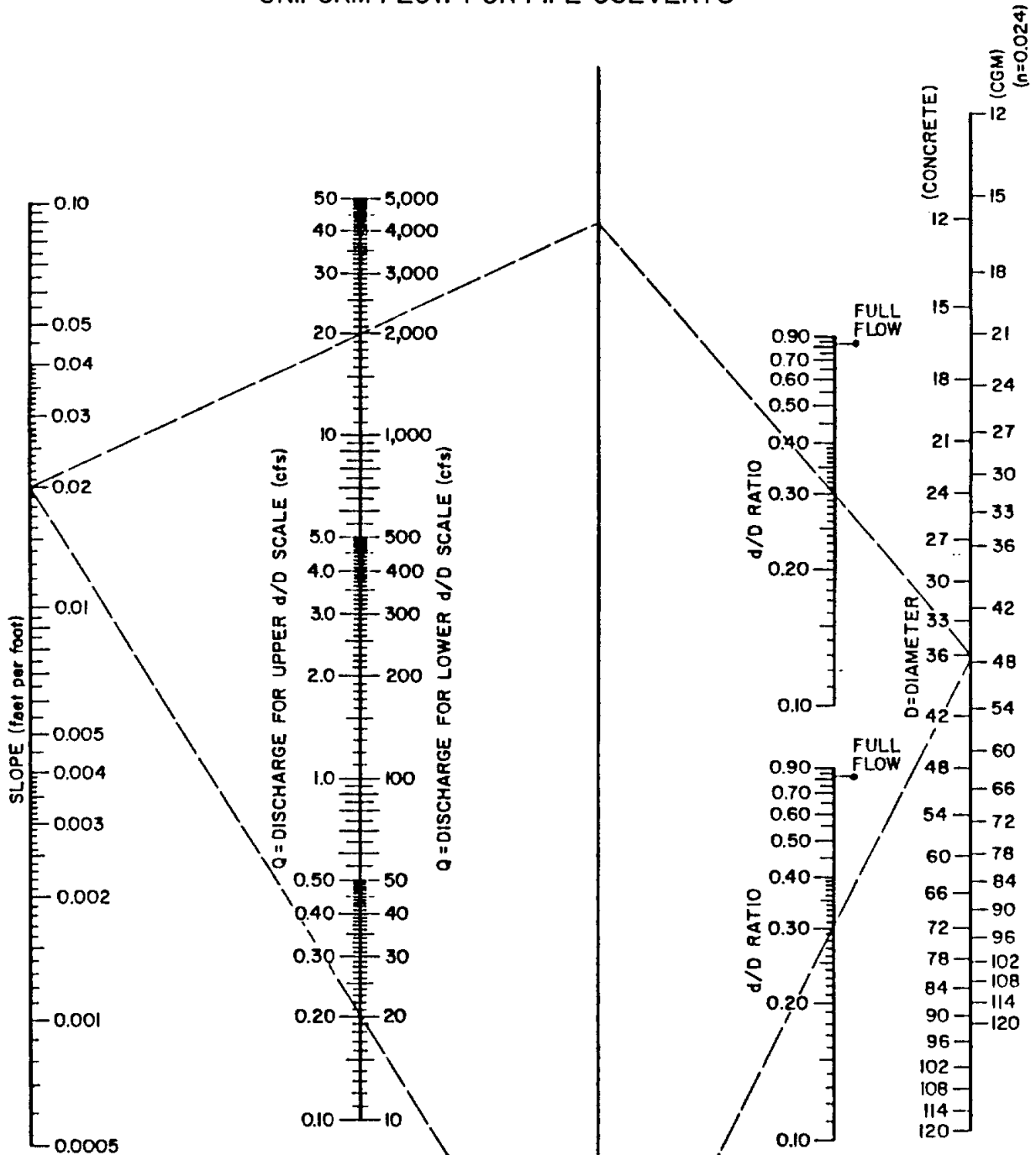

EXAMPLE

GIVEN: $S = 0.02$ FIND: $d/D =$
 $Q = 20 \text{ cfs}$ $d =$
 $D = 36'' \text{ (CONCRETE)}$

SOLUTION

$d/D = 0.30$
 $d = 0.30 \times 3' = 0.9'$

FIGURE 5-2

CRITICAL DEPTH OF FLOW FOR CIRCULAR CONDUITS

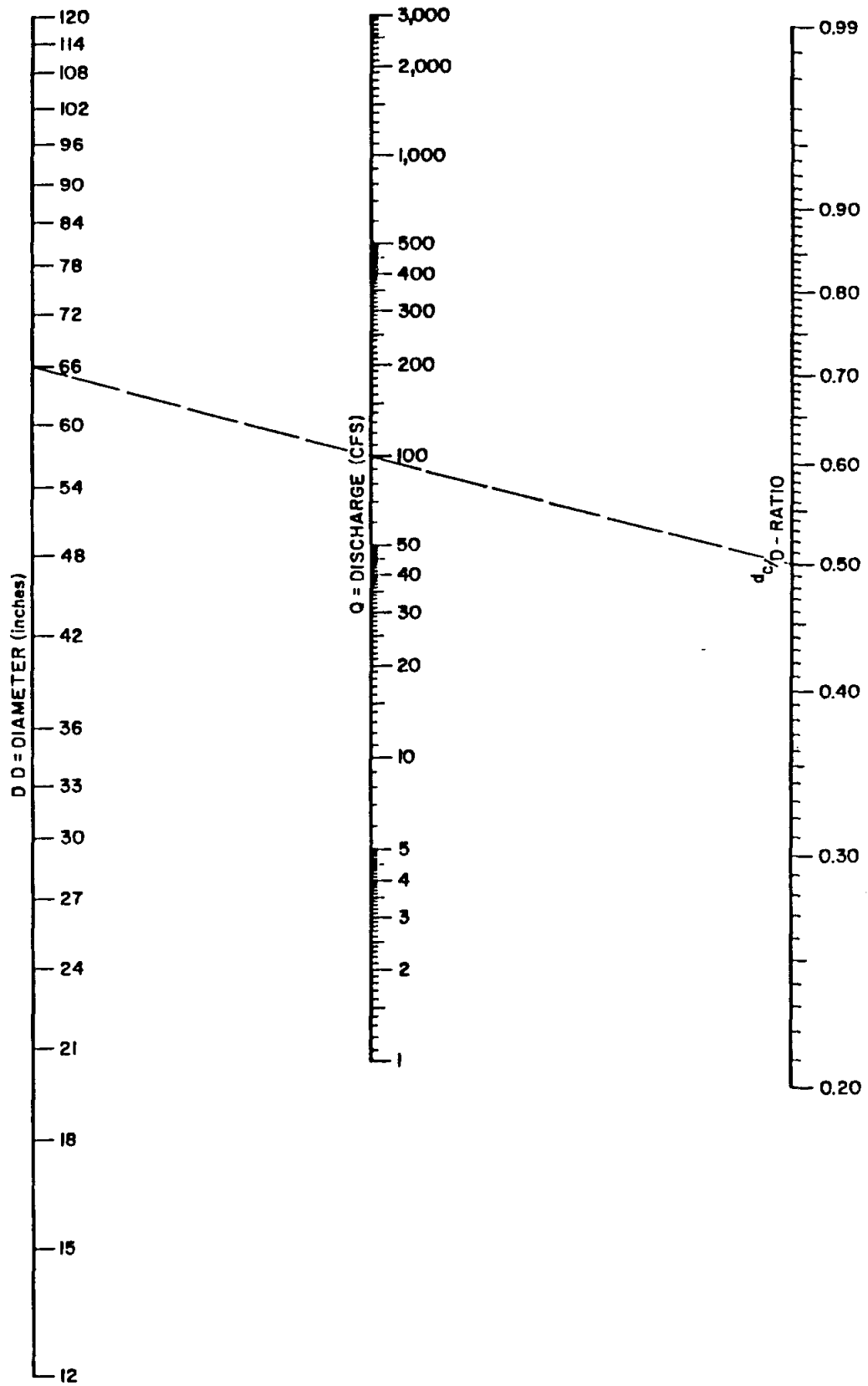

FIGURE 5-3

VELOCITY IN PIPE CONDUITS

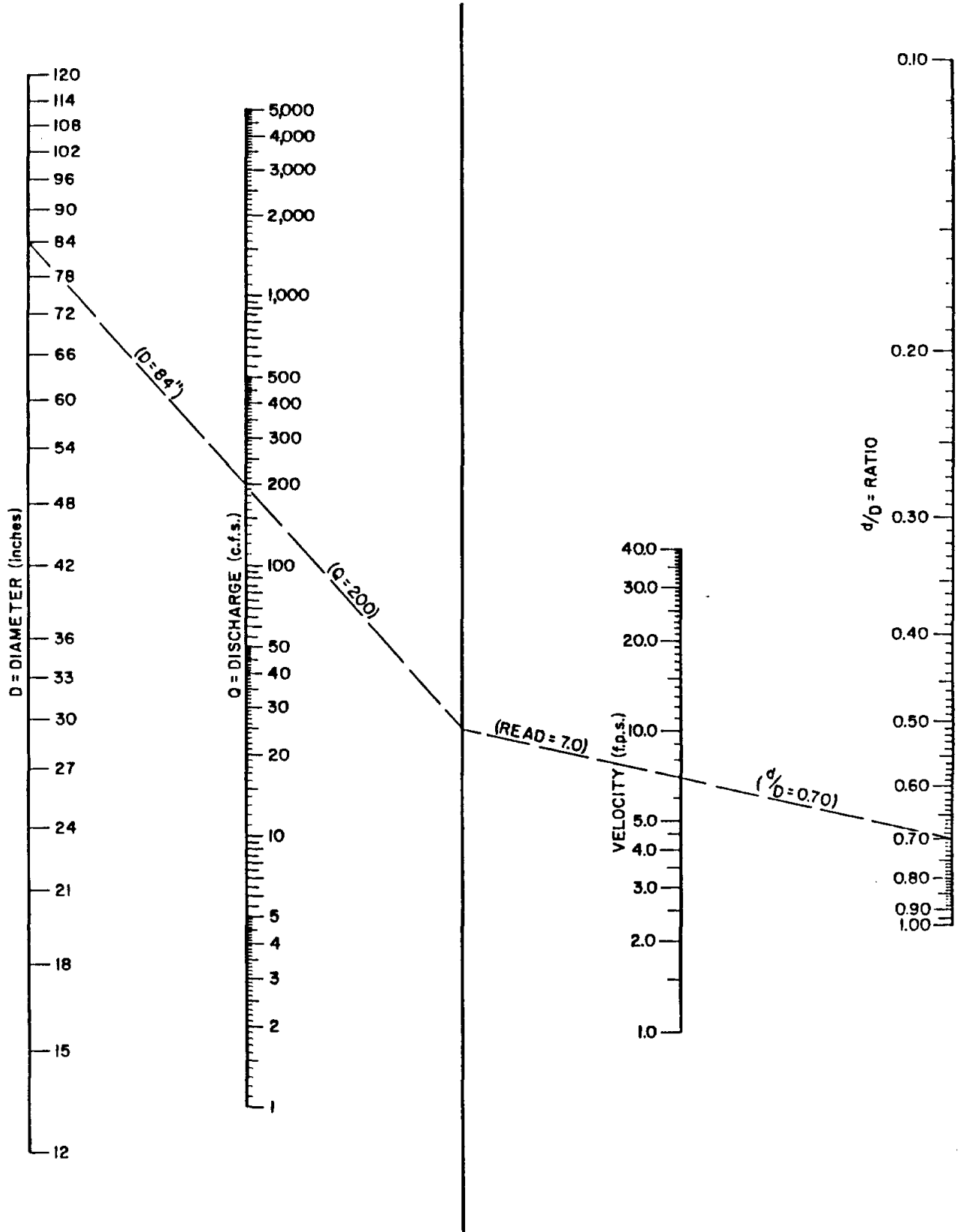

FIGURE 5-4

UNIFORM FLOW FOR CONCRETE ELLIPTICAL PIPE

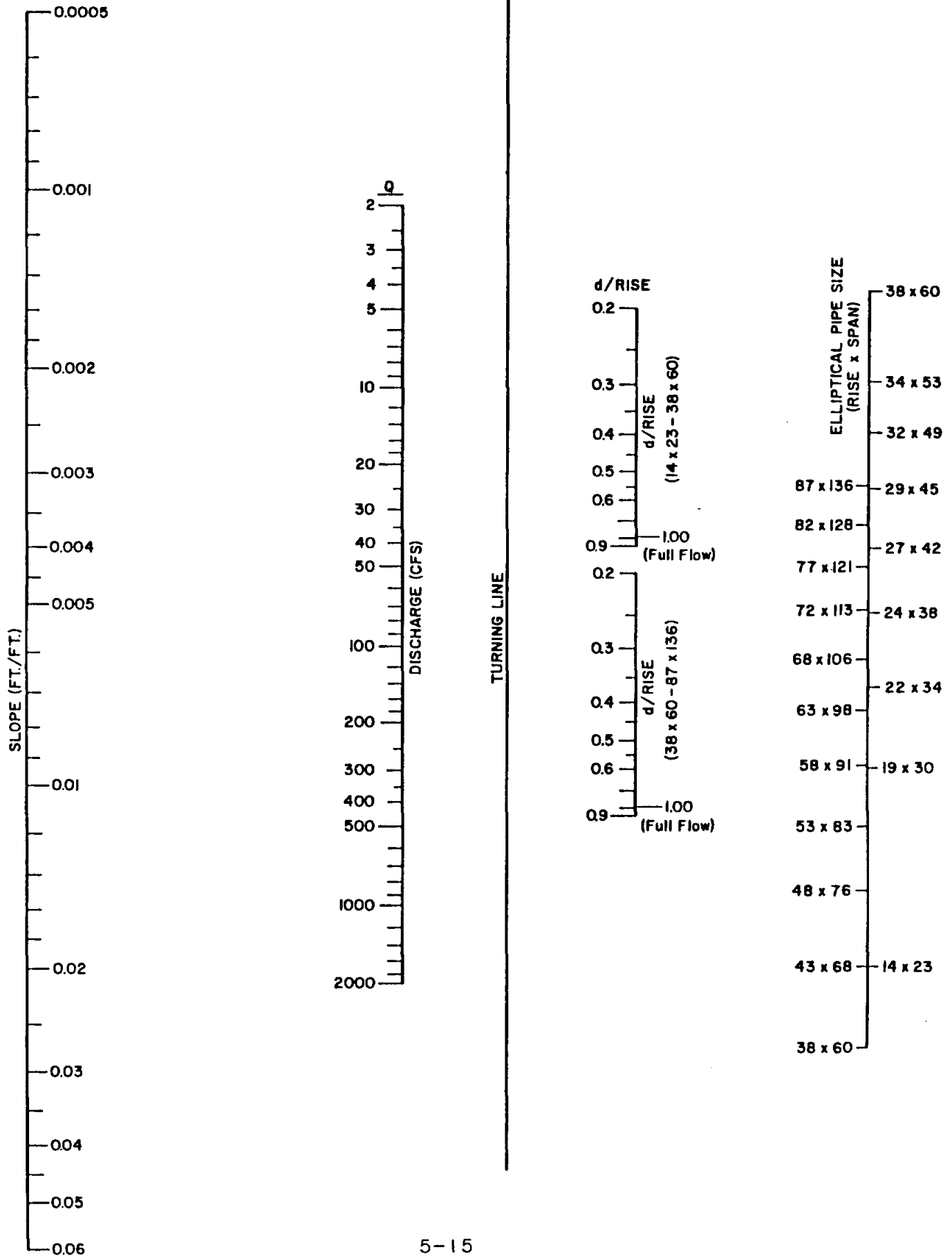

FIGURE 5-5

CRITICAL DEPTH FOR ELLIPTICAL PIPE

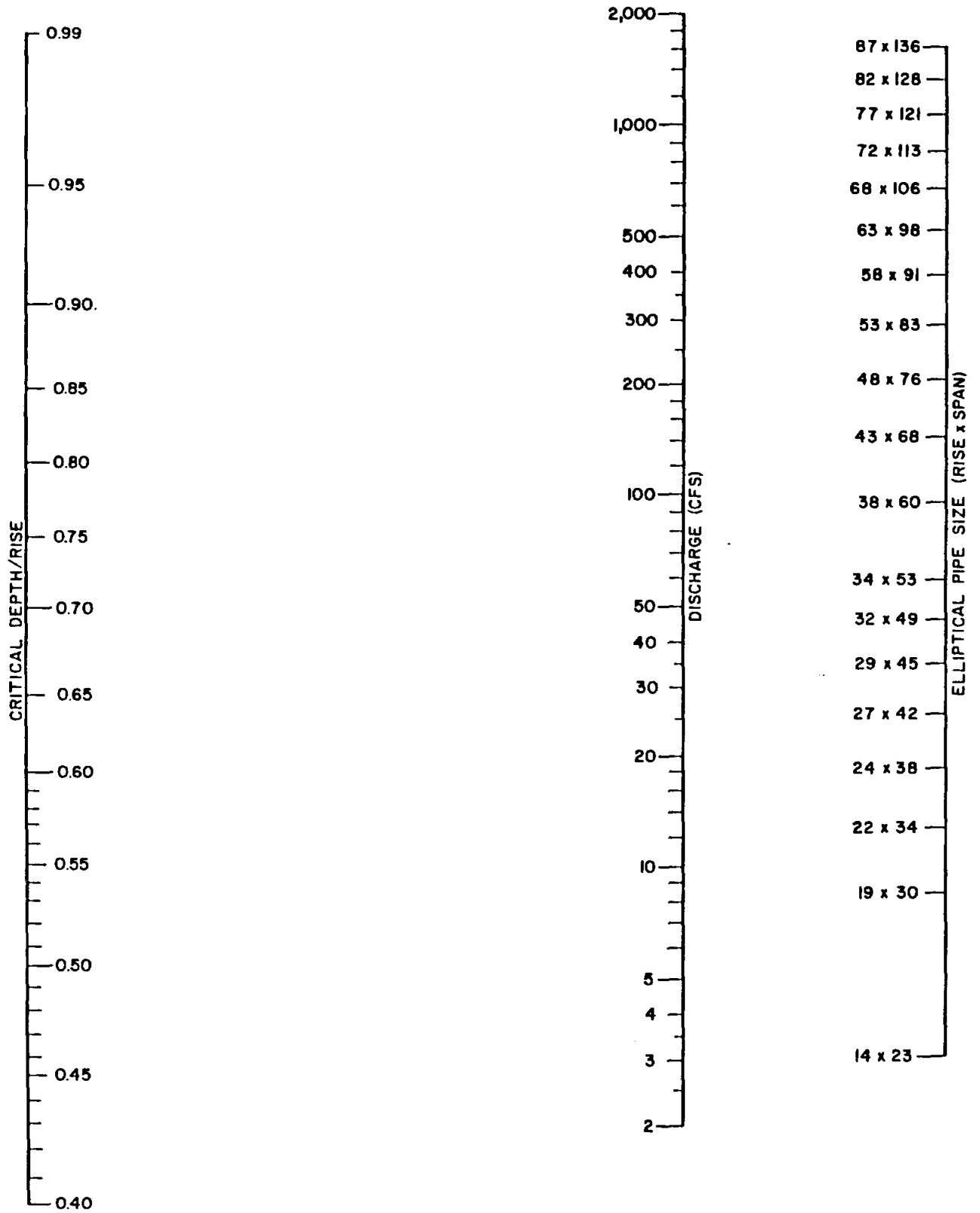

FIGURE 5-6

VELOCITY IN ELLIPTICAL PIPE

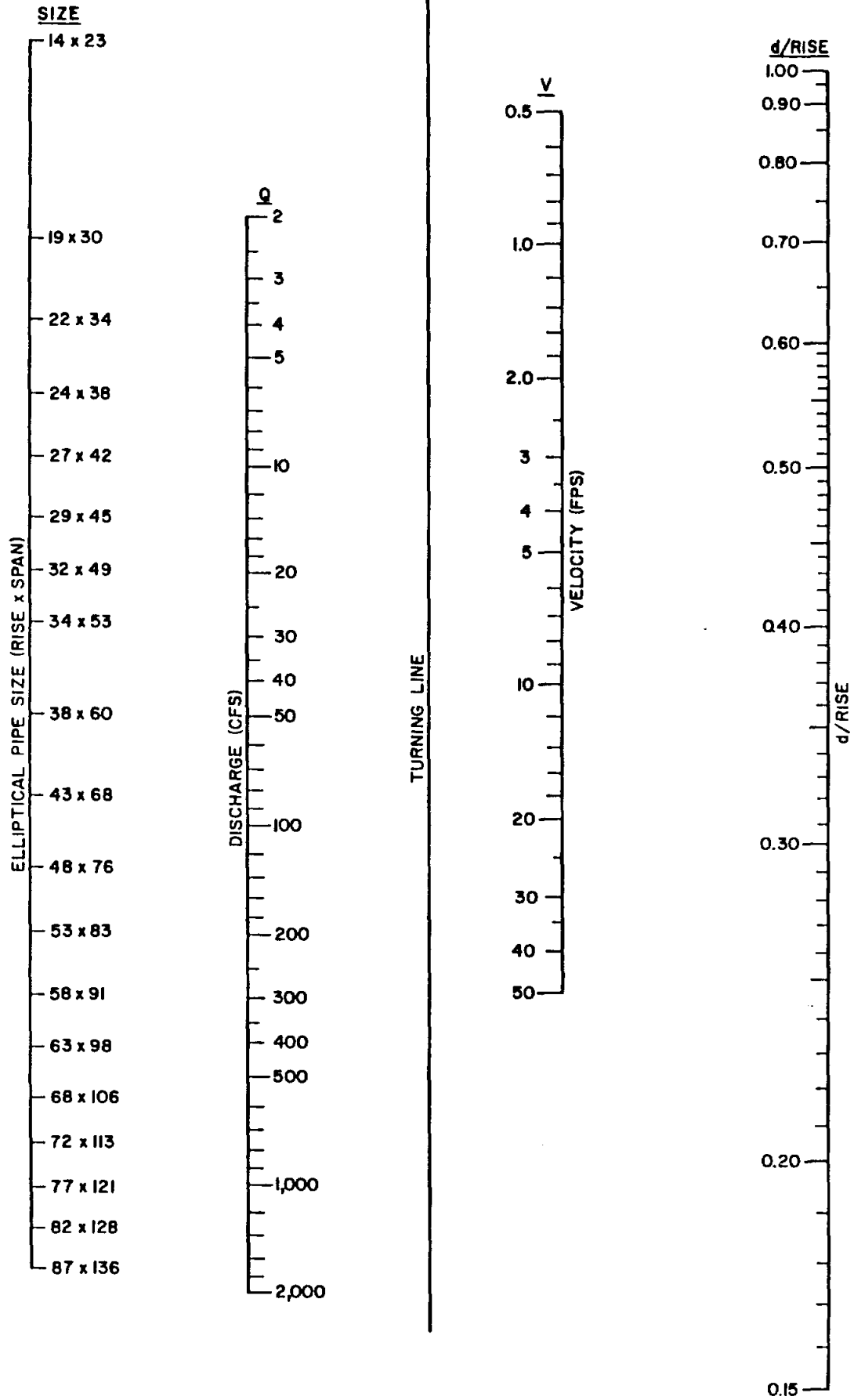

FIGURE 5-7

UNIFORM FLOW FOR PIPE ARCH

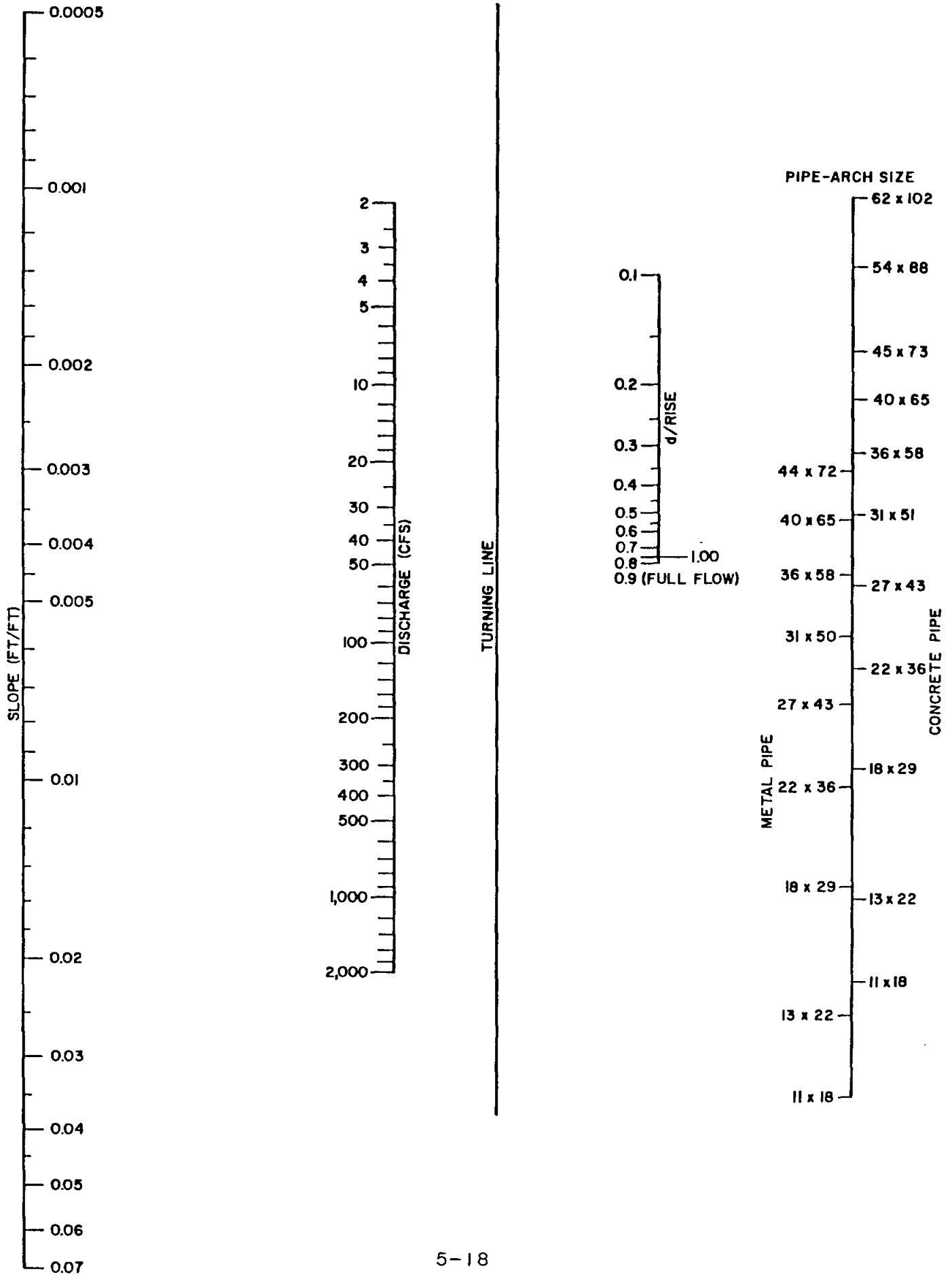

FIGURE 5-8

CRITICAL DEPTH OF FLOW FOR PIPE-ARCH

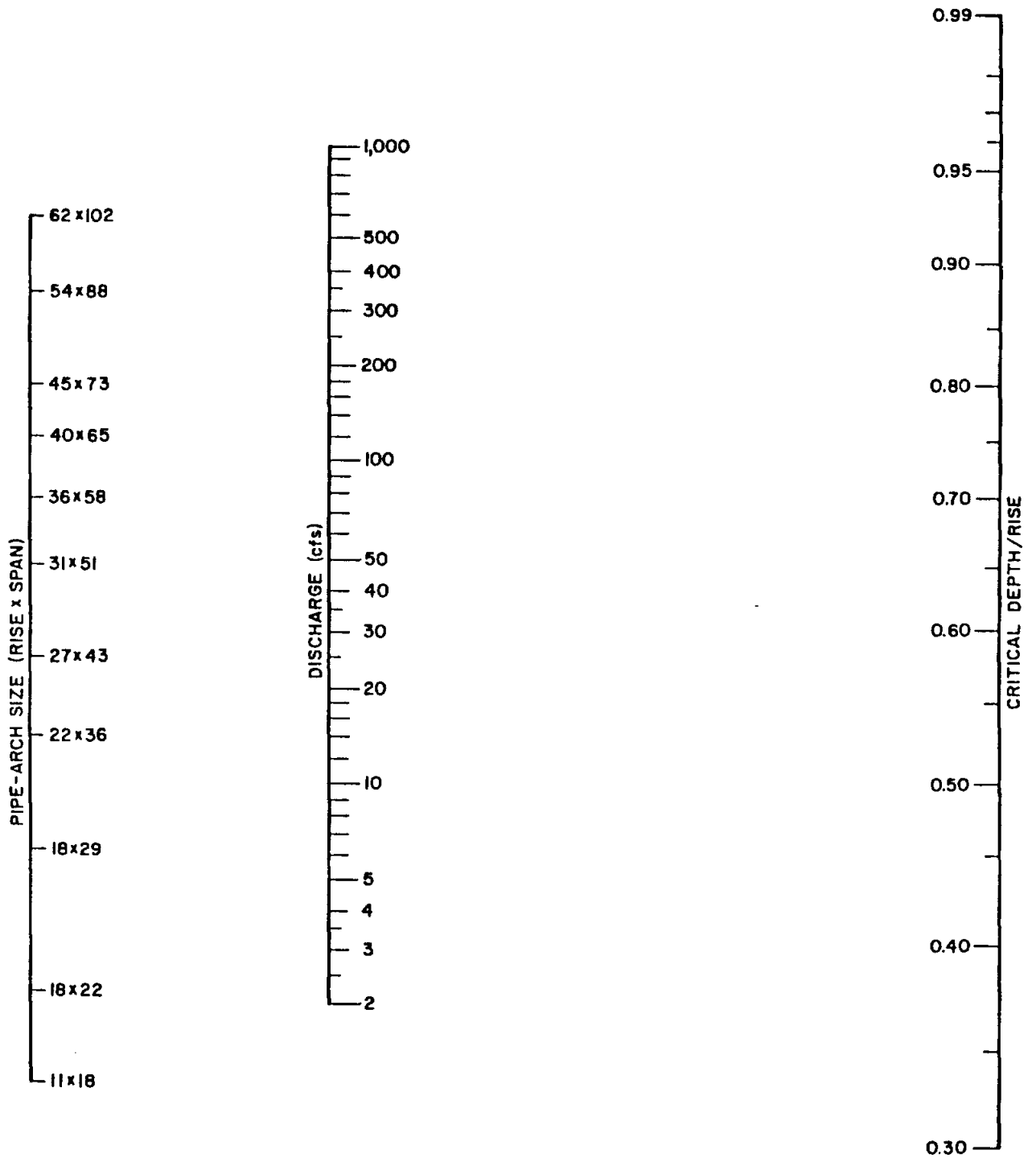
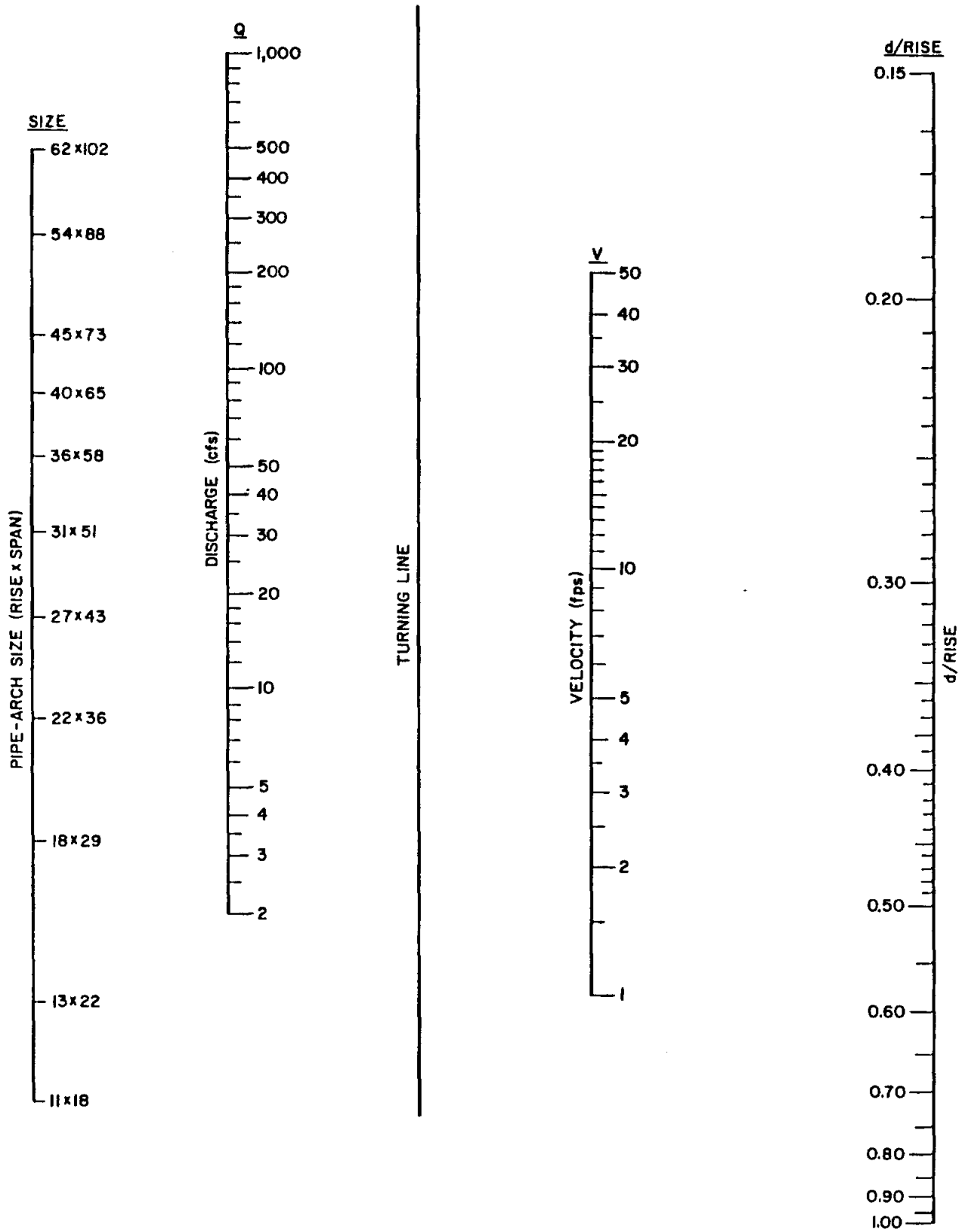

FIGURE 5-9

VELOCITY IN PIPE-ARCH



MINOR HEAD LOSSES DUE TO
TURBULENCE AT STRUCTURES

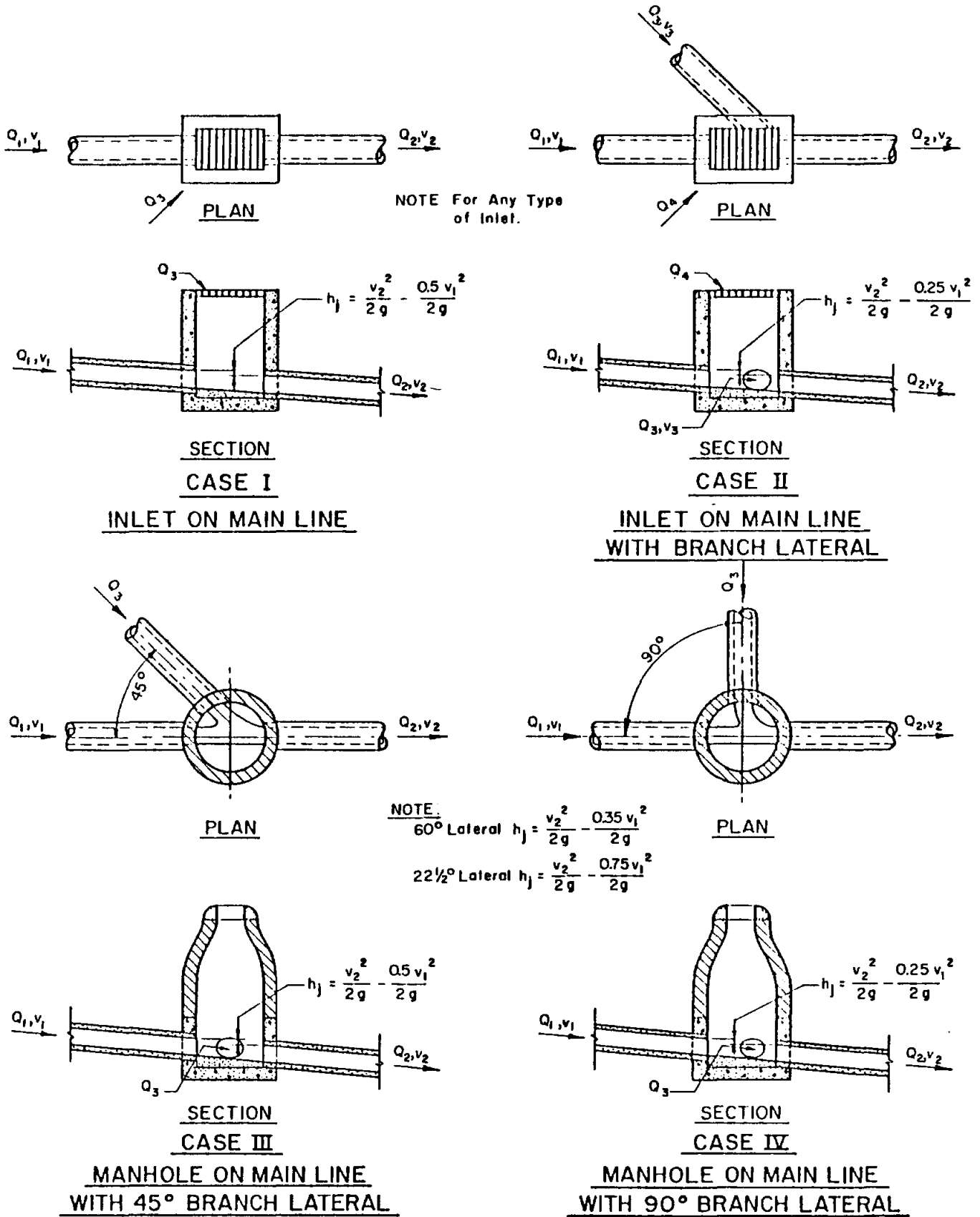
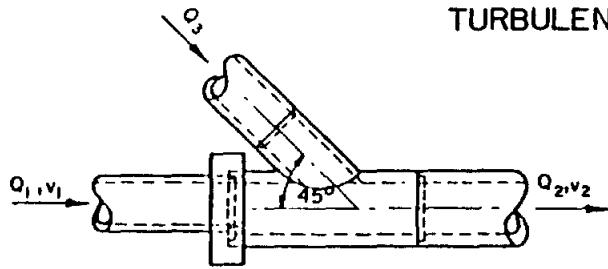
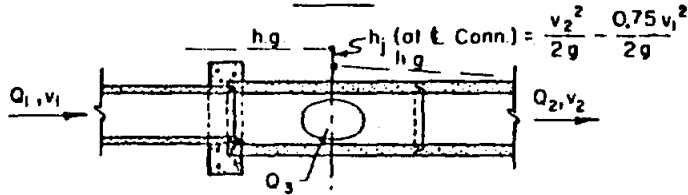

FIGURE 5-10
(Continued)

MINOR HEAD LOSSES DUE TO
TURBULENCE AT STRUCTURES



PLAN



SECTION

CASE V

45° WYE CONNECTION
OR CUT IN

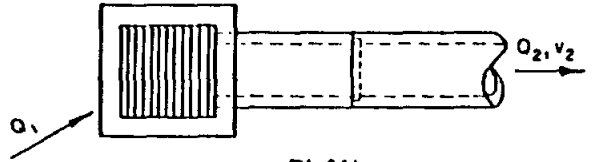

PLAN

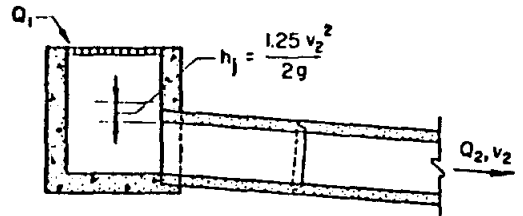

SECTION

CASE VI

INLET OR MANHOLE AT
BEGINNING OF LINE

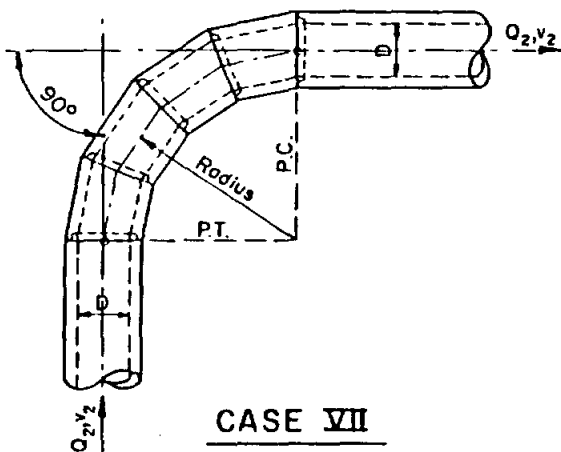

CASE VII

CONDUIT ON 90° CURVES*

NOTE: Head loss applied at P.C. for length of curve.

Radius = Dia. of Pipe $h_j = 0.50 \frac{v_2^2}{2g}$

Radius = (2-8) Dia. of Pipe $h_j = 0.25 \frac{v_2^2}{2g}$

Radius = (8-20) Dia. of Pipe $h_j = 0.40 \frac{v_2^2}{2g}$

Radius = Greater than 20 Dia. of Pipe $h_j = 0$

* When curves other than 90° are used, apply the following factors to 90° curves.

60° curve 85%

45° curve 70%

22 1/2° curve 40%

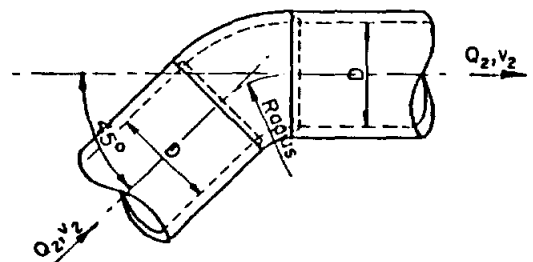

CASE VIII

BENDS WHERE RADIUS IS
EQUAL TO DIAMETER OF PIPE

NOTE: Head loss applied at beginning of bend

90° Bend $h_j = 0.50 \frac{v_2^2}{2g}$

60° Bend $h_j = 0.43 \frac{v_2^2}{2g}$

45° Bend $h_j = 0.35 \frac{v_2^2}{2g}$

22 1/2° Bend $h_j = 0.20 \frac{v_2^2}{2g}$

SECTION 6 - OPEN CHANNEL FLOW

6.10 GENERAL

Open channels for use in the major drainage system have significant advantage in regard to cost, capacity, multiple use for recreational and aesthetic purposes, and potential for detention storage. Disadvantages include right-of-way needs and maintenance costs. Careful planning and design are needed to minimize the disadvantages and to increase the benefits.

The ideal channel is a natural one carved by nature over a long period of time. The benefits of such a channel are that:

Velocities are usually low, resulting in a longer time of concentration and lower downstream peak flows.

Channel storage tends to decrease peak flows.

Maintenance needs are usually low because the channel is somewhat stabilized.

The channel provides a desirable green belt and recreational area adding significant social benefits.

Generally speaking, the natural channel or the man-made channel that most nearly conforms to the character of a natural channel is the most efficient and the most desirable.

In many areas facing urbanization, the runoff has been so minimal that natural channels do not exist. However, small trickle paths nearly always exist and these provide an excellent basis for location and construction of channels. Good land planning should reflect even these minimal trickle channels to reduce development costs and minimize drainage problems. In some cases the prudent utilization of natural water routes in the development of a major drainage system will reduce the requirements for an underground storm sewer system.

Channel stability has become a recognized problem in urban hydrology because of the significant increase in low flows and peak storm runoff rates. A natural channel must be studied to determine the measures needed to avoid future bottom scour and bank cutting. Erosion control measures can be taken at reasonable cost which will preserve the natural appearance without sacrificing hydraulic efficiency.

6.20 CHANNEL DISCHARGE

6.21 Manning's Equation

Careful attention must be given to the design of drainage channels to assure adequate capacity and minimum maintenance to overcome

the results of erosion and silting. The hydraulic characteristics of channels can be determined by Manning's equation:

$$Q = \frac{1.49}{n} A R^{2/3} S_f^{1/2}$$

where:

Q = Total discharge in cfs.

n = Coefficient of roughness.

A = Cross-sectional area of channel in sq. ft.

R = Hydraulic radius of channel in ft = $\frac{A}{W_p}$.

W_p = Wetted perimeter in ft.

S_f = Slope of the frictional gradient in ft/ft.

6.22 Uniform Flow

For a given channel condition of roughness, discharge and slope, there is only one possible depth for maintaining a uniform flow. This depth is the normal depth. When roughness, depth and slope are known at a channel section, there can be only one discharge for maintaining a uniform flow through the section. This discharge is the normal discharge.

If the channel is uniform and resistance and gravity forces are in exact balance, the water surface will be parallel to the bottom of the channel. This is the condition of uniform flow.

Uniform flow is more often a theoretical abstraction than an actuality. True uniform flow is difficult to find in the field or to obtain in the laboratory. Channels are sometimes designed on the assumption that they will carry uniform flow at the normal depths, but because of conditions difficult if not impossible to evaluate and hence not taken into account, the flow will actually have depths considerably different from uniform depth. The engineer must be aware of the fact that uniform flow computation provides only an approximation of what will occur.

6.23 Normal Depth

The normal depth is computed so frequently that it is convenient to use nomographs for various types of cross sections to eliminate the need for trial and error solutions, which are time consuming. Nomographs for uniform flow are given in Figures 6-1 and 6-2.

FIGURE 6-1

UNIFORM FLOW FOR TRAPEZOIDAL CHANNELS

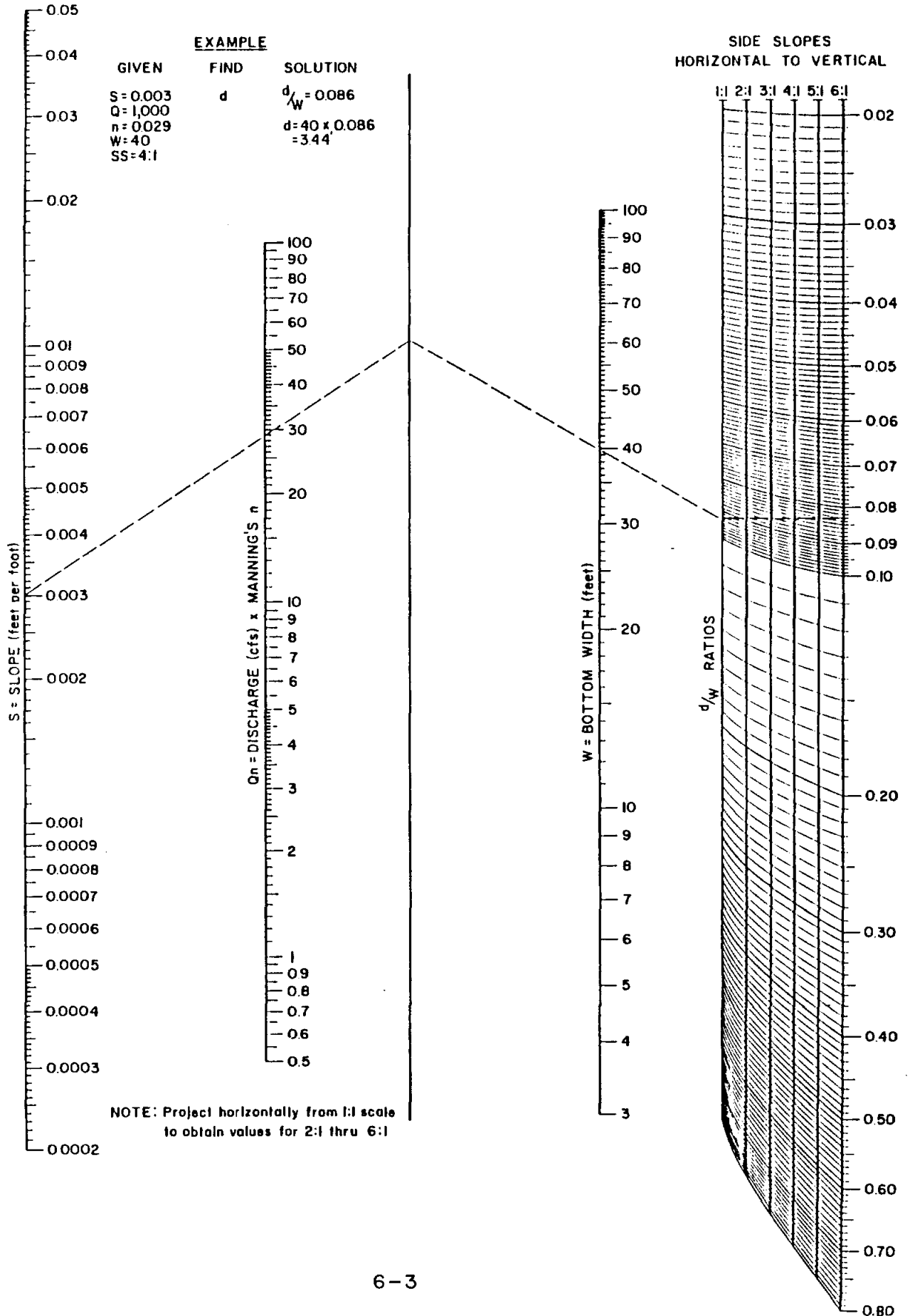
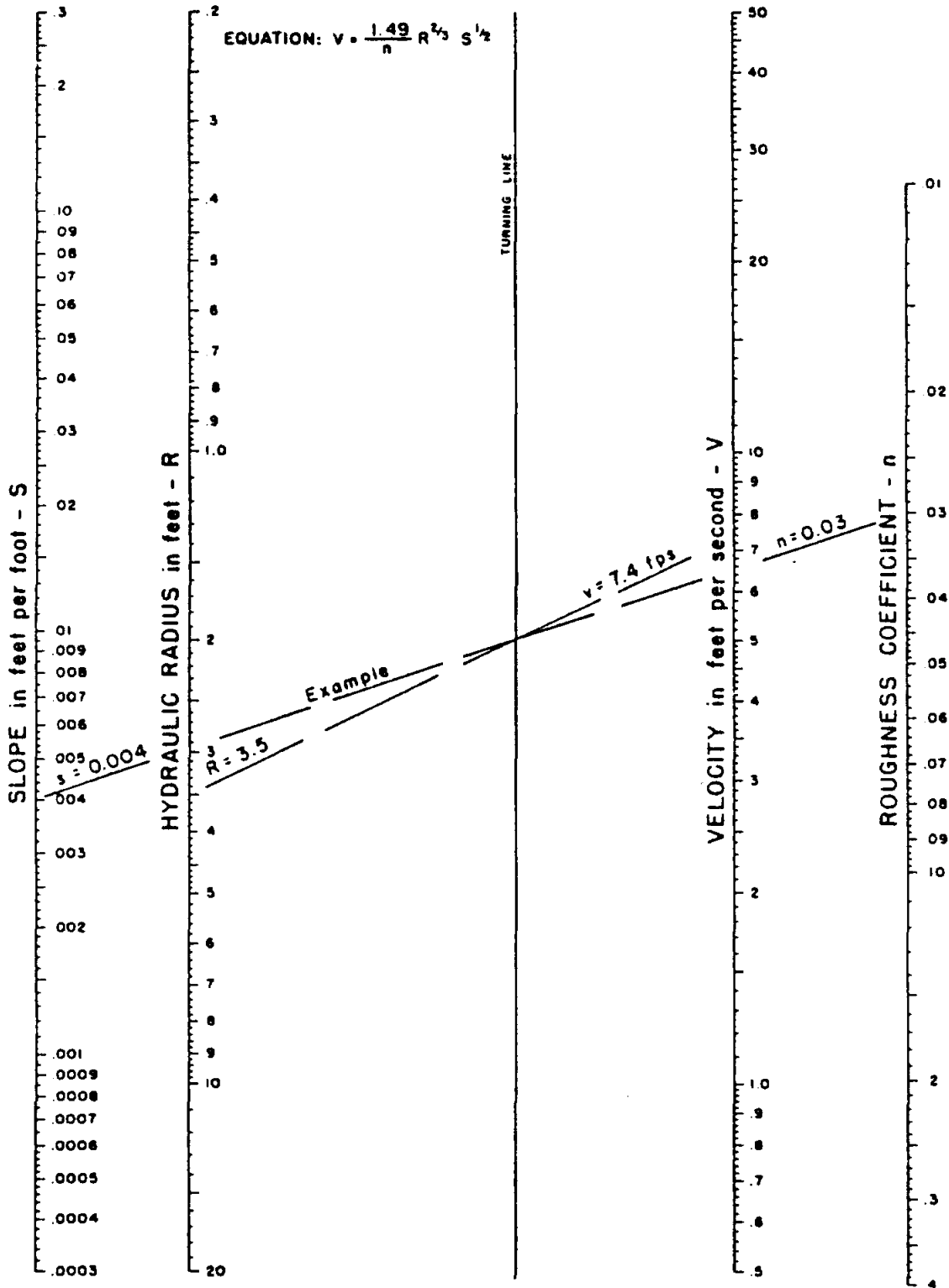

FIGURE 6-2

MANNING'S FORMULA NOMOGRAPH



6.30 DESIGN CONSIDERATIONS

Man-made channels should have trapezoidal sections of adequate cross-sectional areas to take care of uncertainties in runoff estimates, changes in channel coefficients, channel obstructions and silt accumulations.

Accurate determination of the "n" value is critical in the analysis of the hydraulic characteristics of a channel reach and should be based on experience and judgement with regard to the individual channel characteristics. Table 6-1 gives a method of determining the composite roughness coefficient based on actual channel conditions, and Table 6-2 provides additional guidance in the selection of "n" values for various types of channels and channel conditions.

Where practicable and depending upon the type of soil, unlined channels should have sufficient gradient to provide velocities that will be self-cleaning but will not be so great as to create erosion. Lined channels, drop structures, check dams, or concrete spillways may be required to control erosion that results from the high velocities of large volumes of water. Unless approved otherwise by the County Commissioners, channel velocities in man-made channels should not exceed 6 fps.

6.40 CHANNEL CROSS SECTIONS

The channel shape may be almost any type suitable to the location and to the environmental conditions. Often the shape can be chosen to suit open space and recreational needs that create additional sociological benefits.

6.41 Side Slope

Normally slopes shall be no steeper than 3:1, which is also the practical limit for mowing equipment. Rock or concrete lined channels or those which for other reasons do not require slope maintenance may have slopes as steep as 1-1/2:1.

6.42 Depth

Deep channels are difficult to maintain and can be hazardous. Constructed channels should therefore be as shallow as practical with due consideration of cost and available right-of-way.

TABLE 6-1

COMPOSITE ROUGHNESS COEFFICIENT "n" FOR CHANNELS*

$$n = (n_0 + n_1 + n_2 + n_3 + n_4) m$$

	<u>Channel Conditions</u>	<u>Value</u>
n ₀ - Material Involved	Earth	0.020
	Fine Gravel	0.024
	Coarse Gravel	0.028
n ₁ - Degree of Irregularity	Smooth	0.000
	Minor	0.005
	Moderate	0.010
	Severe	0.020
n ₂ - Variation of Channel Cross Section	Gradual	0.000
	Alternating Occasionally	0.005
	Alternating Frequently	0.010 - 0.015
n ₃ - Relative Effect Of Obstructions	Negligible	0.000
	Minor	0.010 - 0.015
	Appreciable	0.020 - 0.030
	Severe	0.040 - 0.060
n ₄ - Vegetation	Low	0.005 - 0.010
	Medium	0.010 - 0.025
	High	0.025 - 0.050
	Very High	0.050 - 0.100
m - Degree of Meandering	Minor	1.000
	Appreciable	1.150
	Severe	1.300

* Reference 10.

TABLE 6-2

ROUGHNESS COEFFICIENT "n" FOR CHANNELS*

<u>Type of Channel and Description</u>	<u>Minimum</u>	<u>Normal</u>	<u>Maximum</u>
EXCAVATED OR DREDGED			
a. Earth, straight and uniform			
1. Clean, recently completed	0.016	0.018	0.020
2. Clean, after weathering	0.018	0.022	0.025
3. Gravel, uniform section, clean	0.022	0.025	0.030
4. With short grass, few weeds	0.022	0.027	0.033
b. Earth, winding and sluggish			
1. No vegetation	0.023	0.025	0.030
2. Grass, some weeds	0.025	0.030	0.033
3. Dense weeds or aquatic plants in deep channels	0.030	0.035	0.040
4. Earth bottom and rubble sides	0.028	0.030	0.035
5. Stony bottom and weedy banks	0.025	0.035	0.040
6. Cobble bottom and clean sides	0.030	0.040	0.050
c. Dragline-excavated or dredged			
1. No vegetation	0.025	0.028	0.033
2. Light brush on banks	0.035	0.050	0.060
d. Rock cuts			
1. Smooth and uniform	0.025	0.035	0.040
2. Jagged and irregular	0.035	0.040	0.050
e. Channels not maintained, weeds and brush uncut			
1. Dense weeds, high as flow depth	0.050	0.080	0.120
2. Clean bottom, brush on sides	0.040	0.050	0.080
3. Same, highest stage of flow	0.045	0.070	0.110
4. Dense brush, high stage	0.080	0.100	0.140

* Reference 10.

TABLE 6-2
(cont.)

<u>Type of Channel and Description</u>	<u>Minimum</u>	<u>Normal</u>	<u>Maximum</u>
NATURAL STREAMS			
a. Minor streams on plain (top width at flood stage < 100 feet)			
1. Clean, straight, full stage, no rifts or deep pools	0.025	0.030	0.033
2. Same as above, but more stones and weeds	0.030	0.035	0.040
3. Clean, winding, some pools and shoals	0.033	0.040	0.045
4. Same as above, but some weeds and stones	0.035	0.045	0.050
5. Same as above, lower stages, more ineffective slopes and sections	0.040	0.048	0.055
6. Same as 4, but more stones	0.045	0.050	0.060
7. Sluggish reaches, weedy, deep pools	0.050	0.070	0.080
8. Very weedy reaches, deep pools, or floodways with heavy stand of timber and underbrush	0.075	0.100	0.150
b. Flood plains			
1. Pasture, no brush			
Short grass	0.025	0.030	0.035
High grass	0.030	0.035	0.050
2. Cultivated areas			
No crop	0.020	0.030	0.040
Mature raw crops	0.025	0.035	0.045
Mature field crops	0.030	0.040	0.050
3. Brush			
Scattered brush, heavy weeds	0.035	0.050	0.070
Light brush and trees, in winter	0.035	0.050	0.060
Light brush and trees, in summer	0.040	0.060	0.080
Medium to dense brush, in winter	0.045	0.070	0.110
Medium to dense brush, in summer	0.070	0.100	0.160
4. Trees			
Dense willows, summer, straight	0.110	0.150	0.200
Cleared land with tree stumps, no sprouts	0.030	0.040	0.050
Same as above, but with heavy growth of sprouts	0.050	0.060	0.080

TABLE 6-2
(cont.)

<u>Type of Channel and Description</u>	<u>Minimum</u>	<u>Normal</u>	<u>Maximum</u>
Heavy stand of timber, a few down trees, little undergrowth, flood stage below branches	0.080	0.100	0.120
Same as above, but with flood stage reaching branches	0.100	0.120	0.160
LINED OR BUILT-UP CHANNELS			
a. Corrugated metal	0.021	0.025	0.030
b. Concrete			
1. Trowel finish	0.011	0.013	0.015
2. Float finish	0.013	0.015	0.016
3. Finished, with gravel on bottom	0.015	0.017	0.020
4. Unfinished	0.014	0.017	0.020
5. Gunite, good section	0.016	0.019	0.023
6. Gunite, wavy section	0.018	0.022	0.025
7. On good excavated rock	0.017	0.020	
8. On irregular excavated rock	0.022	0.027	
c. Concrete bottom float finished with sides of			
1. Dressed stone in mortar	0.015	0.017	0.020
2. Random stone in mortar	0.017	0.020	0.024
3. Cement rubble masonry, plastered	0.016	0.020	0.024
4. Cement rubble masonry	0.020	0.025	0.030
5. Dry rubble or riprap	0.020	0.030	0.035
d. Gravel bottom with sides of			
1. Formed concrete	0.017	0.020	0.025
2. Random stone in mortar	0.020	0.023	0.026
3. Dry rubble or riprap	0.023	0.033	0.036
e. Asphalt			
1. Smooth	0.013	0.013	
2. Rough	0.016	0.016	
f. Vegetated	0.030		0.500

6.43 Bottom Width

Channels with narrow bottoms are difficult to maintain and are conducive to high velocities during high flows. It is desirable to design open channels such that the bottom width is at least twice the depth, with 6 to 8 times the depth desirable if consistent with cost and design constraints.

6.44 Trickle Channels

The low flows, and sometimes base flows, from developed areas must be given specific attention. If erosion of the bottom of the channel appears to be a problem, low flows shall be carried in a trickle channel that has a capacity of 5.0 percent of the design peak flow. Care must be taken to insure that low flows do not create an erosion problem.

6.45 Freeboard

For channels with flow at high velocities, surface roughness, wave action, air bulking, and splash and spray are quite erosive along the top of the flow. Freeboard height should be chosen to provide a suitable safety margin. The height of freeboard shall be a minimum of one foot, or provide an additional capacity of approximately one-third of the design flow. From Ref. 1, the formula for deep flows with high velocities is:

$$\text{Freeboard (in feet)} = 1.0 + 0.025 VD^{1/3}$$

where:

V = Velocity of flow in fps.

D = Depth of flow in ft.

For the freeboard of a channel on a sharp curve, extra height must be added to the outside bank or wall in the amount:

$$H = \frac{V^2 (T + B)}{2gR}$$

where:

H = Additional height on outside edge of channel in ft.

V = Velocity of flow in channel in fps.

T = Width of flow at water surface in ft.

B = Bottom width of channel in ft.

R = Centerline radius of turn in ft.

g = Acceleration of gravity, 32 ft/sec².

If R is equal or greater than 3 x B, additional freeboard is not required.

6.50 CHANNEL DROPS

The use of channel drops permits adjustment of channel gradients that are too steep for the design conditions. In urban drainage work it is often desirable to use several low head drops in lieu of a few higher drops. Special attention must be given to protecting the channel from erosion in the area of channel drops.

The use of sloped drops will generally result in lower cost installations. Sloped drops can easily be designed to fit the channel topography.

Sloped drops shall have roughened faces and shall be no steeper than 2:1. They shall be adequately protected from scour and not cause an upstream water surface drop that will result in high velocities upstream. Side cutting just downstream from the drop is a common problem that must be protected against.

The length L will depend upon the hydraulic characteristics of the channel and drop. For a flow of 30 cfs/foot of width, L would be about 15 feet, that is, about $1/2$ of the flow value. L should not be less than 10 feet, even for low flow values. In addition, followup riprapping will often be necessary at most drops to more fully protect the banks and channel bottom.

For additional information on drop spillways, consult the National Engineering Handbook, Section 11, Drop Spillways, SCS Report No. SCS/ENG/NEH-11 NTIS Accession No. PB243645/AS.

6.60 SUPERCritical FLOW

Supercritical flow in an open channel in a developed area creates certain hazards which the designer must take into consideration. From a practical standpoint it is generally not possible to have any curvature in such a channel. Careful attention must be taken to insure against excessive oscillatory waves which may extend down the entire length of the channel from only minor obstructions upstream. Imperfections at joints of lined channels may rapidly cause a deterioration of the joints, in which case a complete failure of the channel can readily occur. In addition, high velocity flow entering cracks or joints creates an uplift force by the conversion of velocity head to pressure head which can damage the channel lining. It is evident that when designing a lined channel with supercritical flow, the designer must use utmost care and consider all relevant factors.

SECTION 7 - CULVERT DESIGN

7.10 GENERAL

The function of a drainage culvert is to pass the design storm flow under a roadway or railroad without causing excessive backwater and without creating excessive downstream velocities.

7.20 DESIGN CRITERIA

The design flow shall be determined by methods described in Section 2.

7.21 Design Frequency

Culverts shall be designed to pass the 25-year runoff with a 2-foot freeboard and no flow over the roadway for areas with a drainage area of less than 5 square miles. Culverts with a drainage area of over 5 square miles shall be designed to pass the 100-year frequency flood event.

At the option of the County Commissioners, the designer may design culverts as storm sewers with a 10-year design frequency. Under this option, the proposed culvert shall be placed on line and grade to permit connection to the future storm sewer. The major storm impacts shall be investigated for both the culvert configuration and the proposed storm sewer configuration. The major storm analysis of the storm sewer shall include upstream and downstream reaches sufficient to show that provisions for the major storm can be made when the storm sewer is constructed.

In areas where an official floodway exists, increases in the 100-year water surface elevation shall not be greater than 1 foot above the natural 100-year water surface elevation.

7.22 Culvert Discharge Velocities

The velocity of discharge from culverts should be limited as shown in Table 7-1. Consideration must be given to the effect of high velocities, eddies or other turbulence on the natural channel, downstream property and roadway embankment.

It is recommended that a minimum velocity of 2.5 feet per second be maintained in all drainage structures to prevent siltation. Where doubt exists concerning silt or scour, protection commensurate with the value of the structure and surrounding property shall be installed to insure that damage to or failure of the structure will not occur.

TABLE 7-1

CULVERT DISCHARGE VELOCITY LIMITATIONS

<u>Downstream Condition</u>	<u>Maximum Allowable Discharge Velocity (fps)</u>
Earth	6 fps
Sod Earth	8 fps
Paved or Riprap Apron	15 fps

7.30 CULVERT TYPES

Culverts shall be selected based on hydraulic principles, economy of size and shape, and a resulting headwater depth that will not cause damage to adjacent property. It is essential to the proper design of a culvert that the conditions under which the culvert will operate are known. Critical depth of flow for circular and rectangular culverts can be determined using the nomographs in Figures 7-7 and 7-8 (see pages 7-11 and 7-12), and these depths, d_c , are to be applied to the sample problems that follow.

Six distinct types of operating conditions as classified by the Texas Department of Highways and Public Transportation (Ref. 7) are illustrated and discussed on the following pages.

7.31 Mild Slope Regime, Critical Depth Control (Outlet Control)

FIGURE 7-1

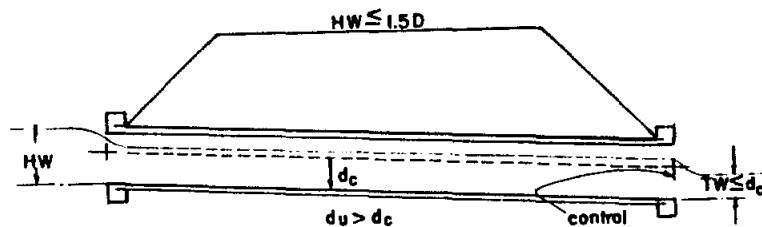

CONDITIONS

The entrance is unsubmerged ($HW \leq 1.5D$), the critical depth is less than uniform depth at design discharge ($d_c < d_u$), and the tailwater is less than or equal to critical depth ($TW \leq d_c$).

The above condition is a common occurrence where the natural channels are on flat grades and have wide, flat floodplains. The control is critical depth at the outlet.

In culvert design, it is generally considered that the headwater pool maintains a constant level during the design storm. If this level does not submerge the culvert inlet, the culvert flows part full.

If critical flow occurs at the outlet, the culvert is said to have "outlet control." A culvert flowing part full with outlet control will require a depth of flow in the barrel of the culvert greater than critical depth while passing through critical depth at the outlet.

The capacity of a culvert flowing part full with outlet control and tailwater depth below critical depth is governed by the following equation when the approach velocity is considered zero.

$$HW = d_c + \frac{V_c^2}{2g} + h_e + h_f - S_0L$$

where:

HW = Headwater depth above the invert of the upstream end of the culvert in feet. Headwater must be equal to or less than 1.5D or entrance is submerged and another type of operation will result.

d_c = Critical depth of flow in ft. (see Figure 7-7 or 7-8).

D = Diameter of pipe or height of box in ft.

g = Acceleration of gravity, 32 ft/sec².

V_c = Critical velocity in fps occurring at critical depth (see Figures 7-7 and 7-8).

h_e = Entrance head loss in ft.

$$h_e = K_e \frac{V_c^2}{2g}$$

K_e = Entrance loss coefficient (see Table 7-2).

h_f = Friction head loss in ft = S_fL .

S_f = Friction slope or slope that will produce uniform flow. For this type of operation, the friction slope is based upon 1.1 d_c .

S_0 = Slope of culvert in ft/ft.

L = Length of culvert in ft.

TABLE 7-2
CULVERT ENTRANCE LOSS COEFFICIENTS

<u>Type of Structure and Design of Entrance</u>	<u>Coefficient K_e</u>
<u>Pipe, Concrete</u>	
Projecting from fill, socket end (groove-end)	0.25
Projecting from fill, sq. cut end	0.55
Headwall or headwall and wingwalls	
Socket end of pipe (groove-end)	0.20
Square-edge	0.50
Rounded (radius = 1/12D)	0.20
Mitered to conform to fill slope	0.70
*End-Section conforming to fill slope	0.50
Beveled edges, 33.7-degree to 45-degree bevels	0.20
Side- or slope-tapered inlet	0.20
<u>Pipe or Pipe-Arch, Corrugated Metal</u>	
Projecting from fill (no headwall)	0.90
Headwall or headwall and wingwalls square-edge	0.50
Mitered to conform to fill slope, paved or unpaved slope	0.70
*End-Section conforming to fill slope	0.50
Beveled edges, 33.7-degree to 45-degree bevels	0.20
Side- or slope-tapered inlet	0.20
<u>Box, Reinforced Concrete</u>	
Headwall parallel to embankment (no wingwalls)	
Square-edged on 3 edges	0.50
Rounded on 3 edges to radius of 1/12 barrel dimension, or beveled edges on 3 sides	0.20
Wingwalls at 30 degrees to 75 degrees to barrel	
Square-edged at crown	0.40
Crown edge rounded to radius of 1/12 barrel dimension, or beveled top edge	0.20
Wingwalls at 10 degrees to 25 degrees to barrel	
Square-edged at crown	0.50
Wingwalls parallel (extension of sides)	
Square-edged at crown	0.70
Side- or slope-tapered inlet	0.20

* Note: "End Section conforming to fill slope," made of either metal or concrete, are the sections commonly available from manufacturers. From limited hydraulic tests they are equivalent in operation to a headwall in both inlet and outlet control. Some end sections incorporating a closed taper in their design have a superior hydraulic performance.

7.32 Mild Slope Regime, Tailwater Depth Control (Outlet Control)

FIGURE 7-2

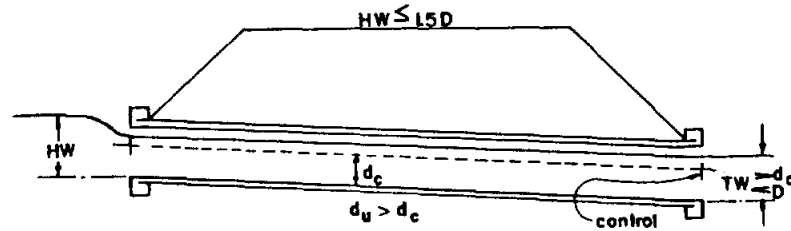

CONDITIONS

The entrance is unsubmerged ($HW \leq 1.5D$), the critical depth is less than uniform depth at design discharge ($d_c < d_u$), and the tailwater is above critical depth and less than culvert depth ($TW > d_c$ and $TW < D$).

The above condition is a common occurrence where the channel is deep, narrow and well defined.

If the headwater pool elevation does not submerge the culvert inlet, the slope at design discharge is subcritical, and the tailwater depth is above critical depth, the control is said to occur at the outlet. The capacity of the culvert is governed by the following equation:

$$HW = TW + \frac{V_{TW}^2}{2g} + h_e + h_f - S_0L$$

where:

HW = Headwater depth above the invert of the upstream end of the culvert in ft. Headwater depth must be equal to or less than $1.5D$ or entrance is submerged and another type of operation will result.

TW = Tailwater depth above the invert of the downstream end of the culvert in ft.

V_{TW} = Culvert discharge velocity in ft/sec at tailwater depth.

g = Acceleration of gravity, 32 ft/sec².

h_e = Entrance head loss in ft.

$$h_e = K_e \frac{(V_{TW})^2}{2g}$$

K_e = Entrance loss coefficient (see Table 7-2).

h_f = Friction head loss in ft = $S_f L$.

S_f = Friction slope or slope that will produce tailwater depth equal to uniform depth.

S_0 = Slope of culvert in ft/ft.

L = Length of culvert in ft.

7.33 Steep Slope Regime, Tailwater Insignificant (Entrance Control).

FIGURE 7-3

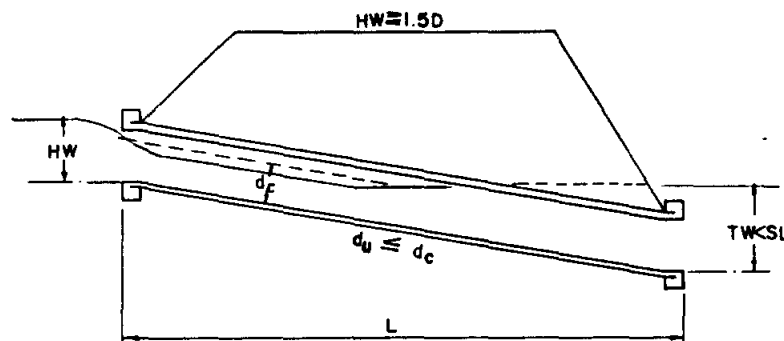

CONDITIONS

The entrance may be submerged or unsubmerged, the critical depth is greater than uniform depth at design discharge ($d_c > d_u$), and the tailwater depth is less than $S_0 L$ (TW elevation < upstream flowline).

This condition is a common occurrence for culverts in rolling or hilly country. The control is critical depth at the entrance for HW values up to about $1.5D$ and entrance geometry for HW values over about $1.5D$.

If critical flow occurs near the inlet, the culvert is said to have "inlet control." The maximum discharge through a culvert flowing part full occurs when flow is at critical depth for a given energy head. To assure that flow passes through critical depth near the inlet, the culvert must be laid on a slope equal to or greater than critical slope for the design discharge. The discharge is limited by the section near the inlet at which critical flow occurs.

The headwater for a culvert flowing under these conditions with control at the inlet is determined from empirical curves in the form of nomographs (see Figures 7-10, 7-13, and 7-14), which will be discussed later in Section 7.52.

7.34 "Slug" Flow Operation (Outlet/Entrance Control).

FIGURE 7-4

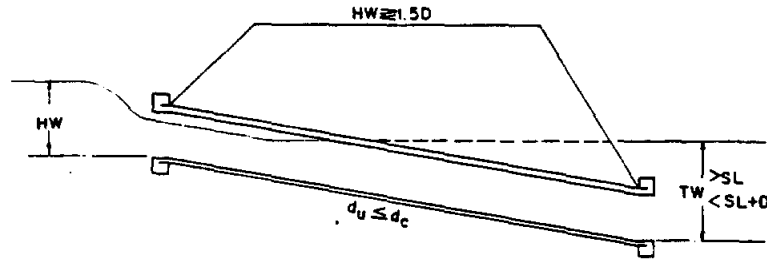

CONDITIONS

The entrance may be submerged or unsubmerged, critical depth is greater than uniform depth at design discharge ($d_c > d_u$), and tailwater elevation is above critical depth at the entrance and below the upstream soffit ($S_0L + d_c < TW < S_0L + D$).

This condition is typical of culverts located in rolling or mountainous country. Control for this type of operation may be at the entrance or the outlet or the control may migrate back and forth between the two (hence, the name "slug" flow).

As the control may shift from the entrance to the outlet, it is recommended that headwater be evaluated for both situations and the higher value be used. Entrance control headwater may be determined from empirical curves (see Section 7.52), and outlet control headwater evaluated by procedures outlined in Section 7.35 and/or 7.36.

7.35 Mild Slope Regime, Tailwater Greater Than Barrel Depth
(Outlet Control)

FIGURE 7-5

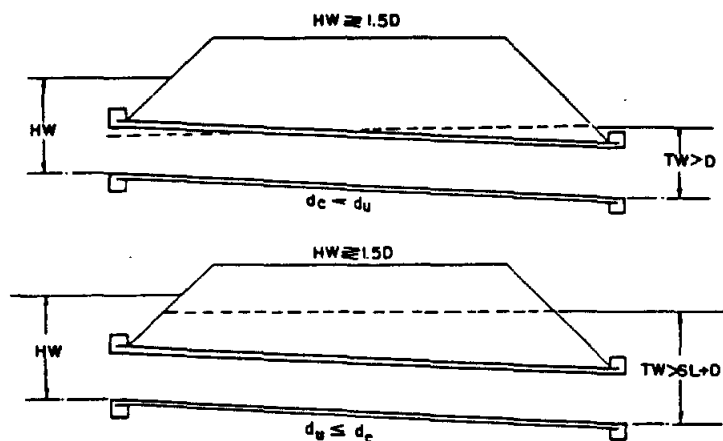

CONDITIONS

Critical depth is less than uniform depth at design discharge ($d_c < d_u$) and tailwater is greater than culvert depth ($TW > D$), or critical depth is greater than uniform depth at design discharge ($d_c > d_u$) and tailwater is above the upstream soffit ($TW > S_0L + D$).

Most culverts flow with free outlet, but depending on topography, a tailwater pool of a depth sufficient to submerge the outlet may form at some installations. For an outlet to be submerged, the depth at the outlet must be equal to or greater than the diameter of pipe or height of box. The capacity of a culvert flowing full with a submerged outlet is governed by the following equation when the approach velocity is considered zero. Outlet velocity is based on full flow at the outlet.

$$HW = H + TW - S_0L$$

where:

HW = Headwater depth in feet above the invert of the upstream end of the culvert.

H = Head for culvert flowing full in ft.

$$H = h_v + h_e + h_f$$

h_v = Velocity head in feet based on full flow in culvert.

$$h_v = \frac{v^2}{2g}$$

h_f = Friction head loss in ft = S_fL .

- h_e = Entrance head loss in ft.
- TW = Tailwater depth in ft.
- S_0 = Slope of culvert in ft/ft.
- L = Length of culvert in ft.

7.36 Mild Slope Regime, Tailwater Less Than Barrel Depth
(Outlet Control)

FIGURE 7-6

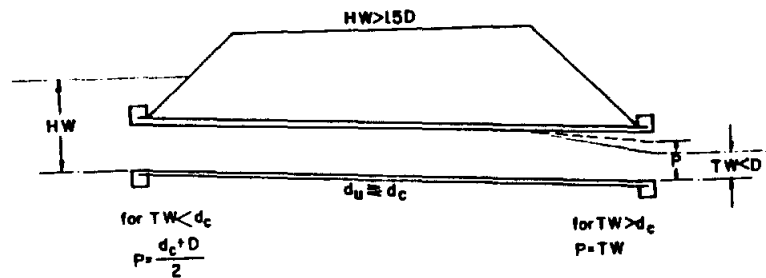

CONDITIONS

- The entrance is submerged ($HW \geq 1.5D$).
- The tailwater depth is less than culvert depth ($TW < D$).

The capacity of a culvert flowing full with a partially submerged outlet is governed by the following equation when the approach velocity is considered zero. Outlet velocity is based on critical depth if TW depth is less than critical depth. If TW depth is greater than critical depth, outlet velocity is based on TW depth.

$$HW = H + P - S_0L$$

where:

- HW = Headwater depth in feet above the invert of the upstream end of the culvert. Headwater depth must be greater than $1.5D$ for entrance to be submerged.
- H = Head for culverts flowing full in ft (see Section 7.3b).

P = Pressure line height in ft.

$$P = \frac{d_c + D}{2} \text{ for } TW < d_c$$

$$P = TW \text{ for } TW > d_c$$

d_c = Critical depth in ft. (see Figure 7-7 or 7-8).

D = Diameter or height of structure in ft.

S_o = Slope of culvert in ft/ft.

L = Length of culvert in ft.

7.40 END TREATMENTS

The normal functions of properly designed headwalls and endwalls are to anchor the culvert to prevent movement, to control erosion and scour resulting from excessive velocities and turbulence, and to prevent adjacent soil from sloughing into the waterway opening. All headwalls shall be constructed of reinforced concrete and may be either straight parallel headwalls, flared headwalls, or warped headwalls with or without aprons as may be required by site conditions.

7.41 Conditions at Entrance

It is important to recognize that the operating characteristics of a culvert may be completely changed by the shape or condition at the inlet or entrance. Design of culverts must involve consideration of energy losses that may occur at the entrance. The entrance head losses may be determined by the following equation:

$$h_e = K_e \frac{V^2}{2g}$$

where:

h_e = Entrance head loss in feet.

V = Velocity of flow in culvert in ft/sec.

K_e = Entrance loss coefficient (See Table 7-2).

g = Acceleration of gravity, 32 ft/sec².

In general, the following guidelines should be used in the selection of the type of headwall or endwalls.

FIGURE 7-7

CRITICAL DEPTH OF FLOW FOR CIRCULAR CONDUITS

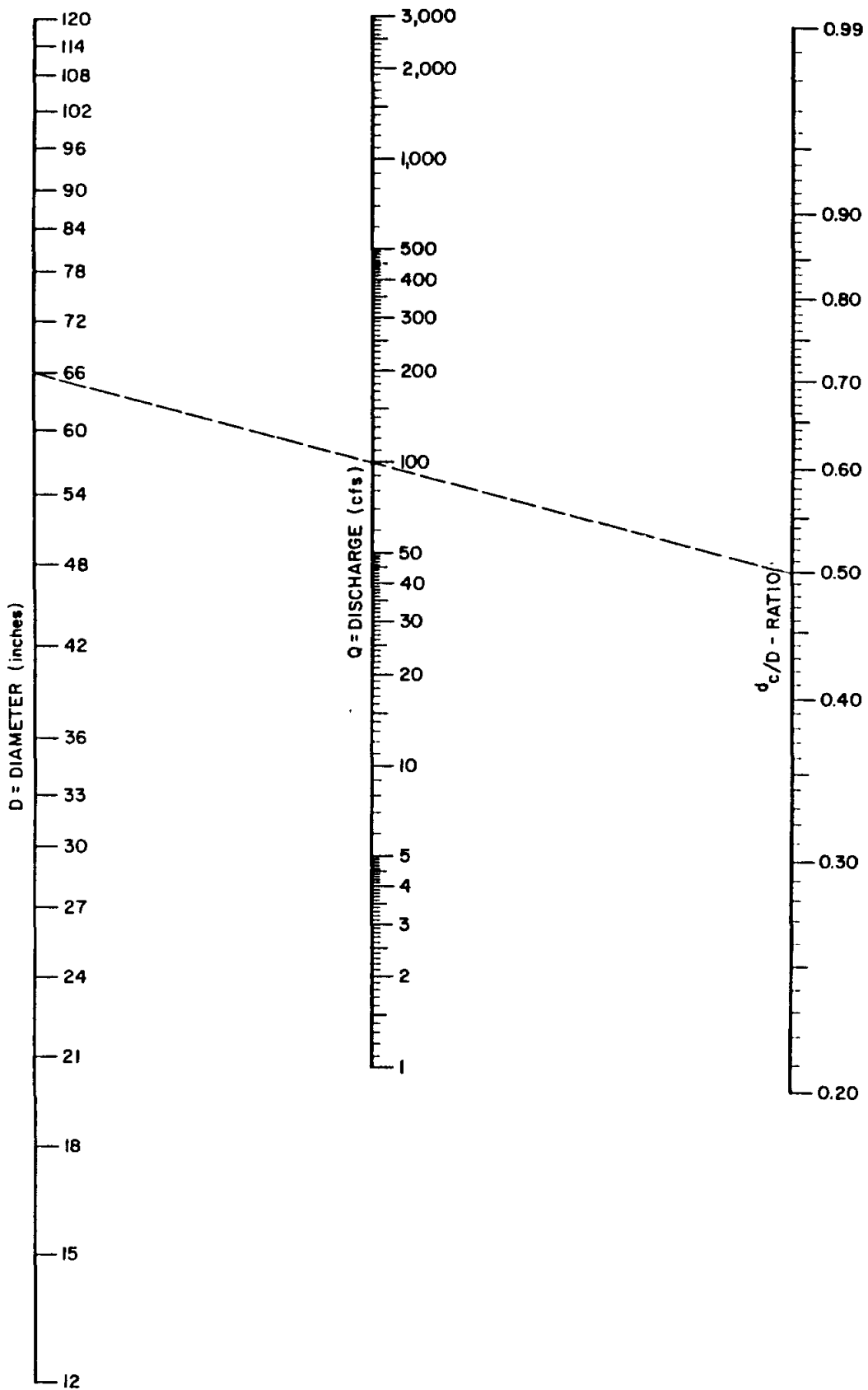
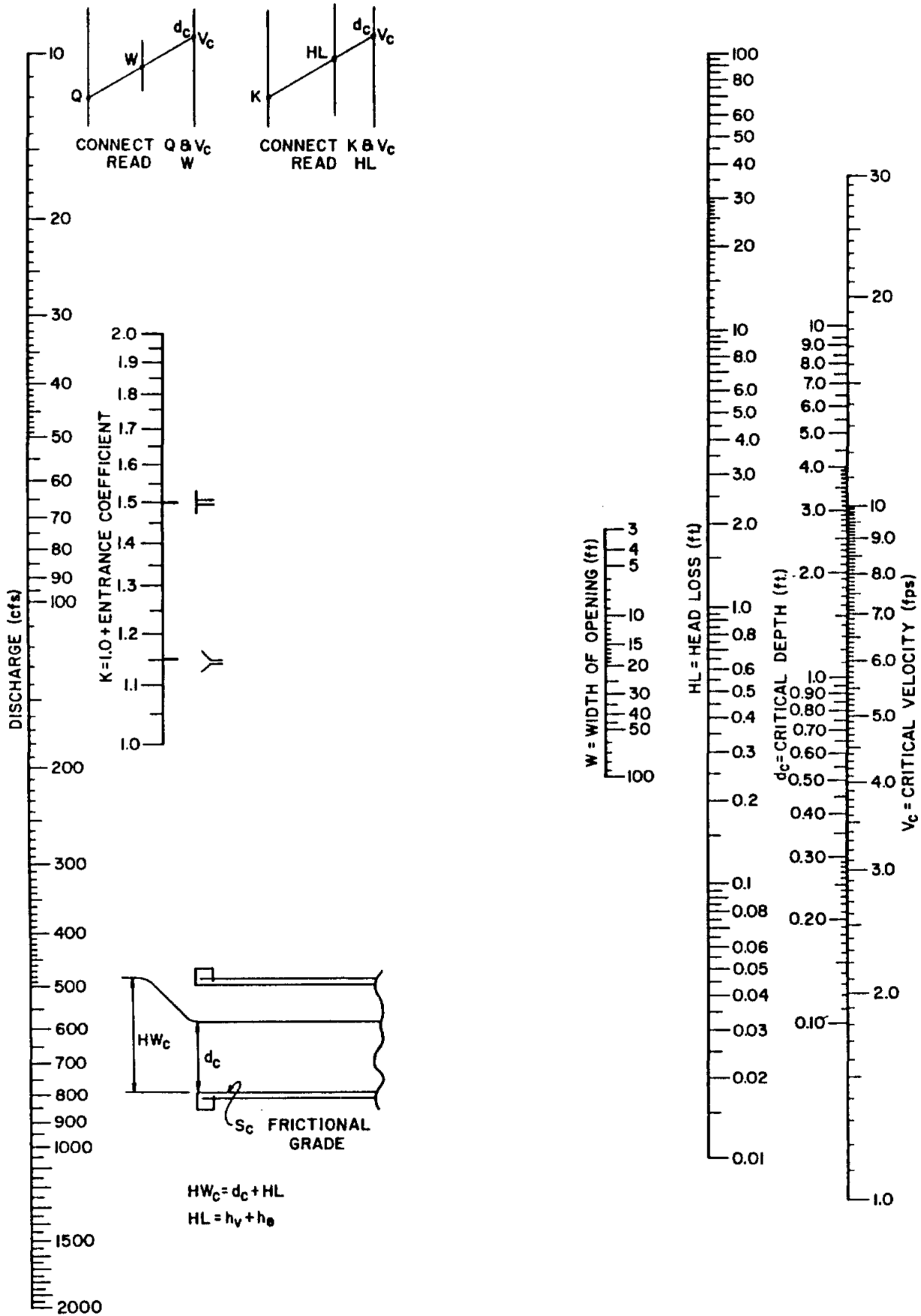

FIGURE 7-8

CRITICAL FLOW FOR BOX CULVERTS



7.42 Parallel Headwall and Endwall

1. Approach velocities are low (below 6 fps).
2. Backwater pools may be permitted.
3. Approach channel is undefined.
4. Ample right-of-way or easement is available.
5. Downstream channel protection is not required.

7.43 Flared Headwall And Endwall

1. Channel is well defined.
2. Approach velocities are between 6 and 10 fps.
3. Medium amounts of debris exist.

7.44 Warped Headwall And Endwall

1. Channel is well defined and concrete lined.
2. Approach velocities are between 8 and 20 fps.
3. Medium amounts of debris exist.

Warped headwalls are effective with dropdown aprons to accelerate flow through culverts, and warped endwalls are effective for transitioning flow from closed conduit flow to open channel flow. This type of headwall should be used only where the drainage structure is large and right-of-way or easement is limited.

7.45 Improved Inlets

Several types of improved inlets have been developed, and the use of these inlets may provide substantial savings by a reduction in the barrel size of the proposed structure. However, the use of those inlets is optional and should be based on an economic analysis by the designer. For box culverts, reinforced concrete structures and structures using headwalls, the use of beveled inlets or tapered inlets is strongly recommended. For more information, the designer is referred to "Hydraulic Design of Improvements for Culverts," Hydraulic Engineering Circular No. 13, August, 1973 (a publication of the U.S. Bureau of Public Roads).

7.50 CULVERT DESIGN WITH STANDARD INLETS

The information and publications necessary to design culverts according to the procedure given in this Section can be found in the "Hydraulic Manual" issued by the Texas Department of Highways and Public Transportation (Ref. 7) and in publications of the Federal Highway Administration (Refs. 2, 3, and 4). The guidelines from these publications that cover the more common requirements are reflected in the nomographs at the end of this Section. For special cases and larger sizes, the Federal Highway Administration publications should be used.

7.51 Culvert Sizing

The nomographs in Figures 7-9 through 7-14 can be used to calculate a series of curves which show the discharge capacity per barrel or per foot width of culvert in cfs for each of several sizes of similar type culverts for various headwater depths in feet above the culvert invert at the inlet. The invert of the culvert is defined as the low point of its cross section.

Culverts shall be selected based on hydraulic principles, economy of size and shape, and a resulting headwater depth that will not cause damage to adjacent property. It is essential to the proper design of a culvert that the conditions under which the culvert will operate are known. The six types of operating conditions (already discussed in Sections 7.31 through 7.36 and represented in Figures 7-1 through 7-6) are:

1. Mild slope regime, critical depth control (outlet control)
2. Mild slope regime, tailwater depth control (outlet control)
3. Steep slope regime, tailwater insignificant (entrance control)
4. "Slug" flow operation (outlet/entrance control)
5. Mild slope regime, tailwater greater than barrel depth (outlet control)
6. Mild slope regime, tailwater less than barrel depth (outlet control)

The headwater depth given by the charts is actually the difference in elevation between the culvert invert at the entrance and the total head (that is, depth plus velocity head) for flow in the approach channel. In most cases, the water surface upstream from the inlet is close to this level and the chart determination may be used as headwater depth for practical design purposes. Where the approach velocity is in excess of 3.0 feet per second, the velocity head must be subtracted from the curve determination of headwater to obtain the actual headwater depth.

7.52 Use Of Nomographs

The following procedure for culvert design requires the use of nomographs, Figures 7-9 through 7-14, developed for both inlet and outlet control.

1. List design data: Q (cfs), L (ft), invert elevations in and out (ft), allowable HW (ft), mean and maximum flood velocities in natural stream (ft/sec), type culvert and entrance type for first selection.
2. Determine a trial size by assuming a maximum average velocity based on channel considerations to compute the area, $A = Q/V$.

3. Find HW for trial size culvert for inlet control and outlet control. For inlet control, use Figure 7-10, 7-13, or 7-14. Next, compute the HW for outlet control with Figure 7-9, 7-11, or 7-12.
4. Compare the computed headwaters and use the higher HW to determine if the culvert is under inlet or outlet control. If outlet control governs and the HW is unacceptable, select a larger trial size and find another HW with the outlet control nomographs. Since the smaller size of culvert had been selected for allowable HW by the inlet control nomographs, the inlet control for the larger pipe need not be checked.

7.60 DESIGN PROCEDURE

Due to problems arising from topography and other considerations, the actual design of a culvert installation is more difficult than the simple process of sizing culverts. The information in the procedure for design will be given as guidelines since the problems encountered are too varied and too numerous to be generalized. However, the design process presented should be followed to insure that some special problem is not overlooked.

7.61 Design Computation Forms

The use of a design computation form is a convenient method to obtain consistent designs with a minimum of culvert cost. An example of such a form is Figure 7-15.

7.62 Invert Elevations

After determining the allowable headwater elevation, tailwater elevation, and approximate length, invert elevations must be assumed. When considering ponded and non-ponded inlets, either for the design discharge or for some lesser storm that will not cause ponding, scour is not likely to occur in an artificial channel, such as a roadside ditch or a major drainage channel, when the culvert has the same slope as the channel. To reduce the chance of failure due to scour, invert elevations corresponding to the natural grade should be used as a first trial. For natural channels, the flow conditions in the channel upstream from the culvert should be investigated to determine if scour will occur.

7.63 Culvert Diameters

After the invert elevations have been assumed and using the Design Computation Forms and the nomographs, the diameter of pipe that will meet the headwater requirements should be determined. The smallest diameter that appears in the nomographs and capacity charts is 12 inches.

Since smaller diameter pipes are often closed by silt, it is recommended that pipe smaller than 18 inches not be used for any drainage where this manual applies. Since pipe roughness influences the culvert diameter, both concrete and corrugated metal pipe should be considered in design, if they satisfy the headwater requirements.

7.64 Limited Headwater

If there is insufficient headwater elevation to obtain the required discharge, it is necessary to either oversize the culvert barrel, lower the inlet invert, use an irregular cross section, or use any combination of the preceding.

If the inlet invert is lowered, special consideration must be given to scour. The use of gabions, concrete drop structures, riprap, or headwalls with apron and toe walls should be evaluated to obtain the proper design.

FIGURE 7-9

OUTLET CONTROL NOMOGRAPH - HEAD FOR
CONCRETE BOX CULVERTS FLOWING FULL,
 $n = 0.012$

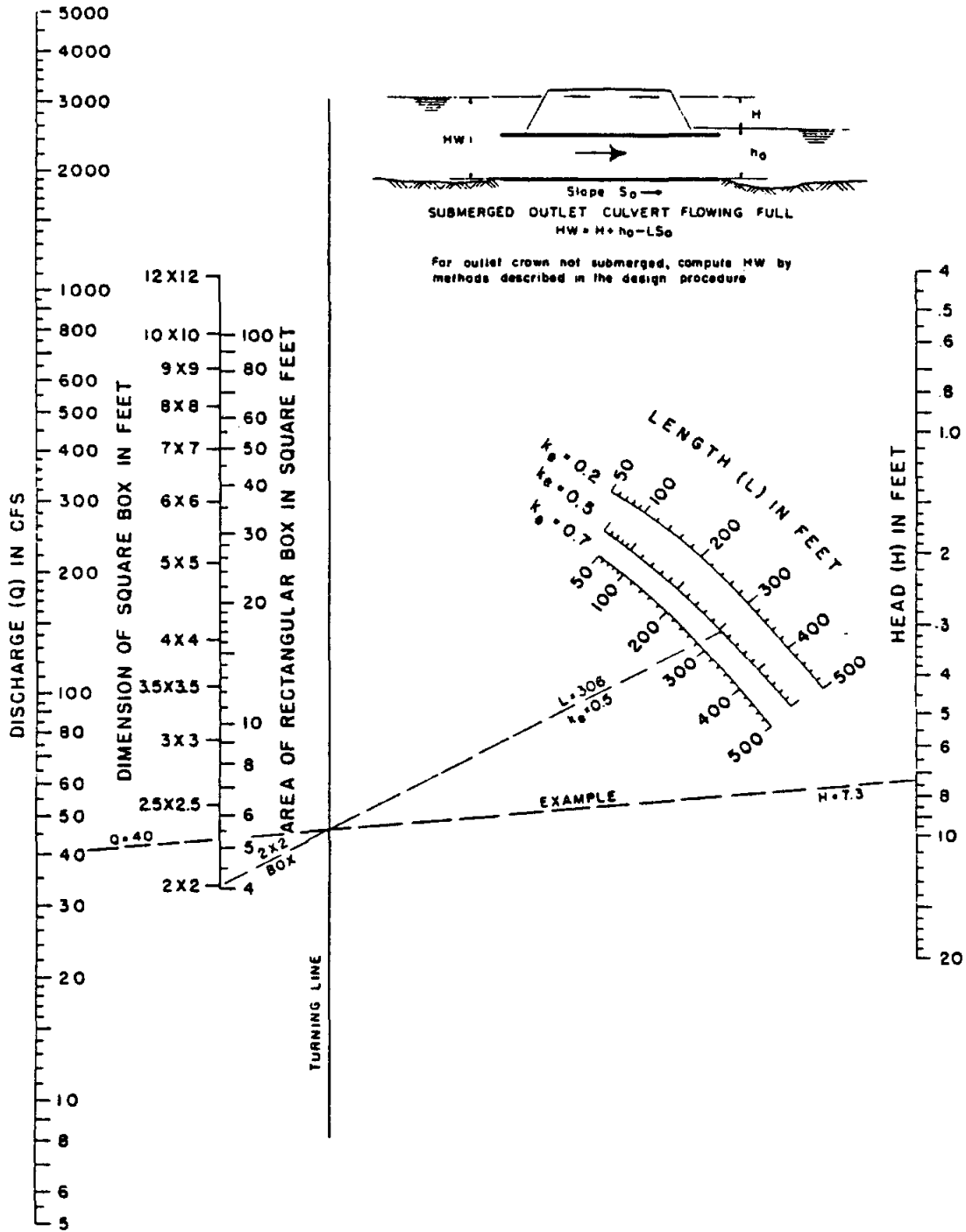

FIGURE 7-10

INLET CONTROL NOMOGRAPH - HEADWATER DEPTH FOR BOX CULVERTS WITH INLET CONTROL

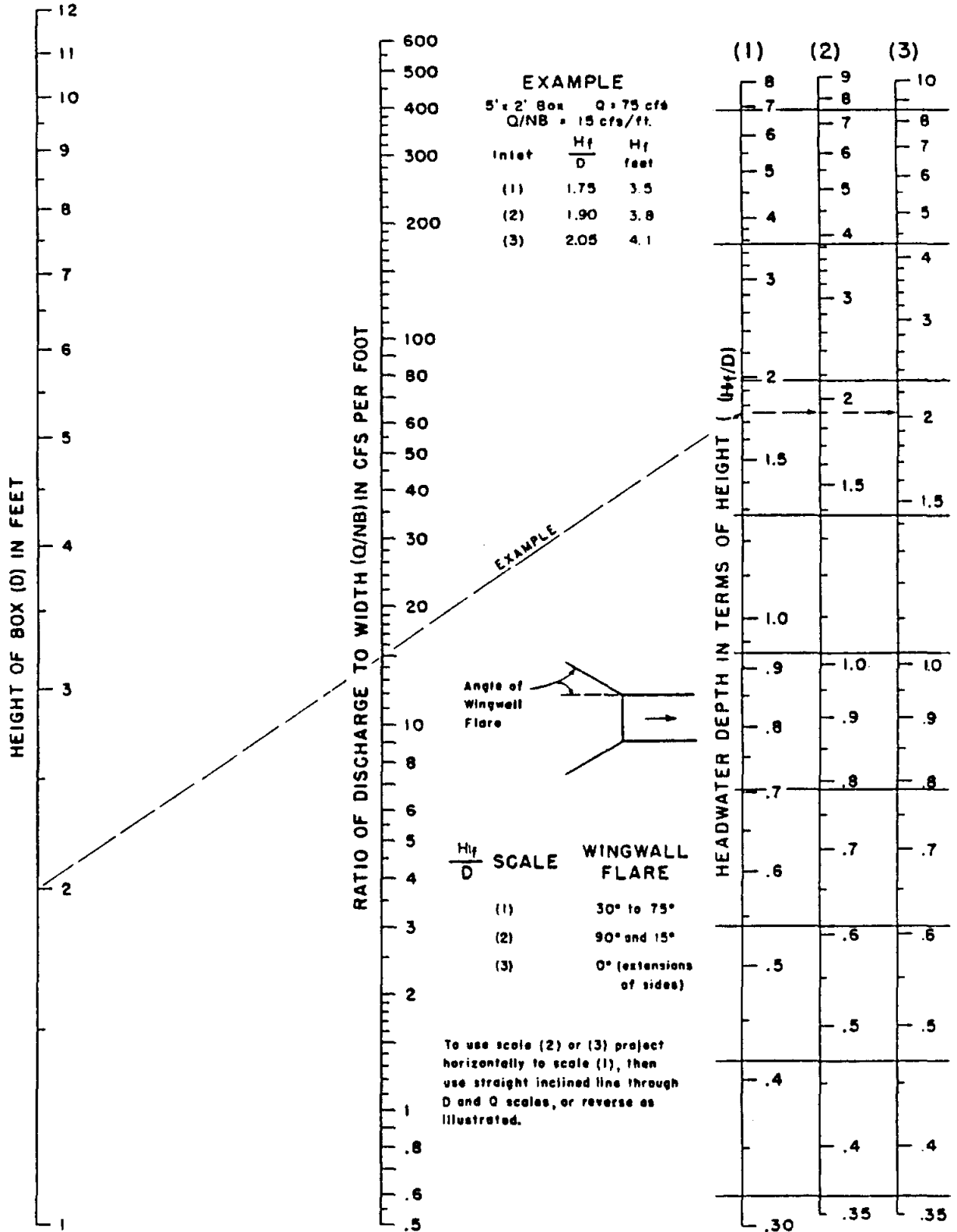

FIGURE 7-11

OUTLET CONTROL NOMOGRAPH - HEAD FOR
 CONCRETE PIPE CULVERT FLOWING FULL,
 $n = 0.012$

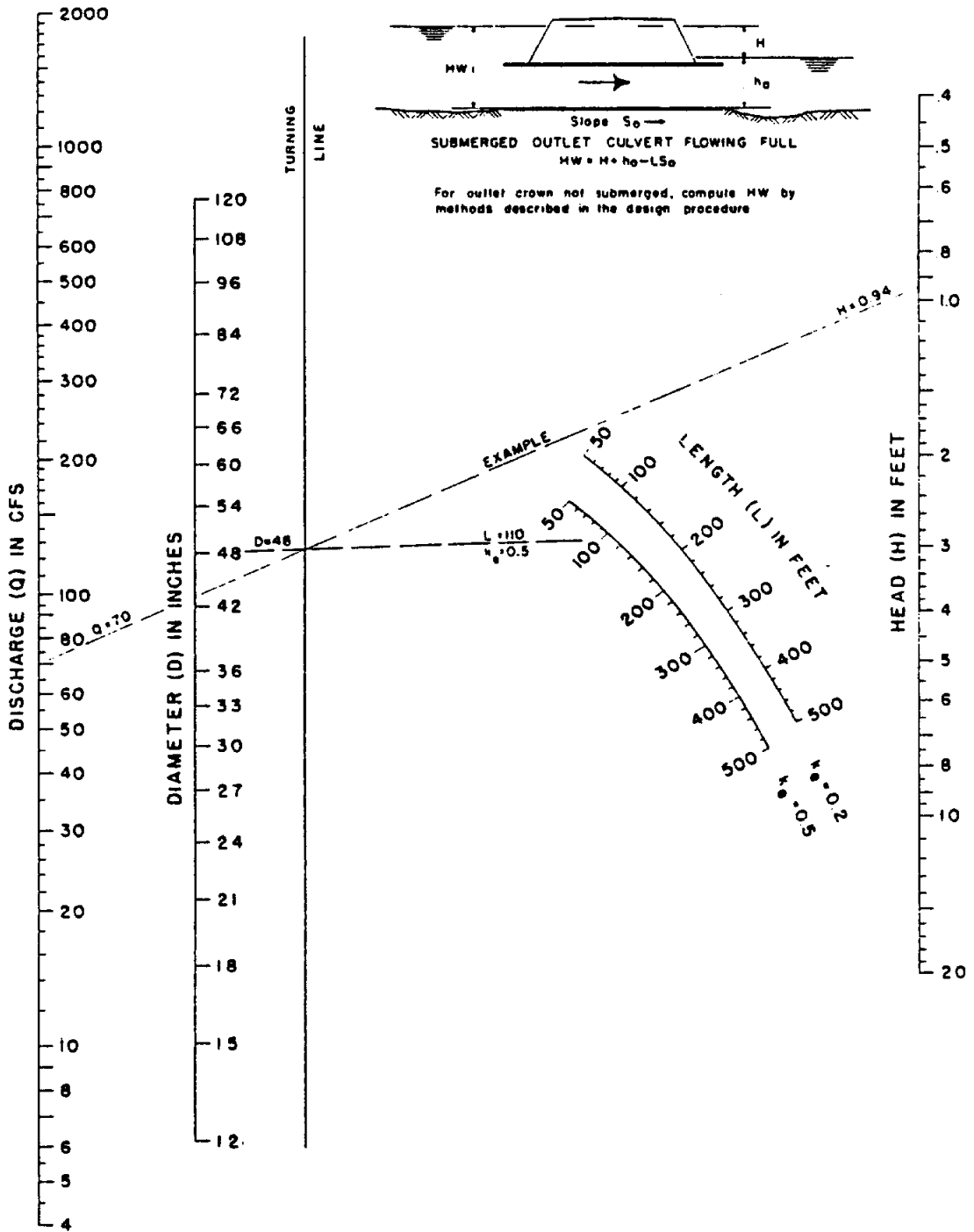

FIGURE 7-12

OUTLET CONTROL NOMOGRAPH - HEAD FOR STANDARD
C. M. PIPE CULVERTS FLOWING FULL, $n=0.024$

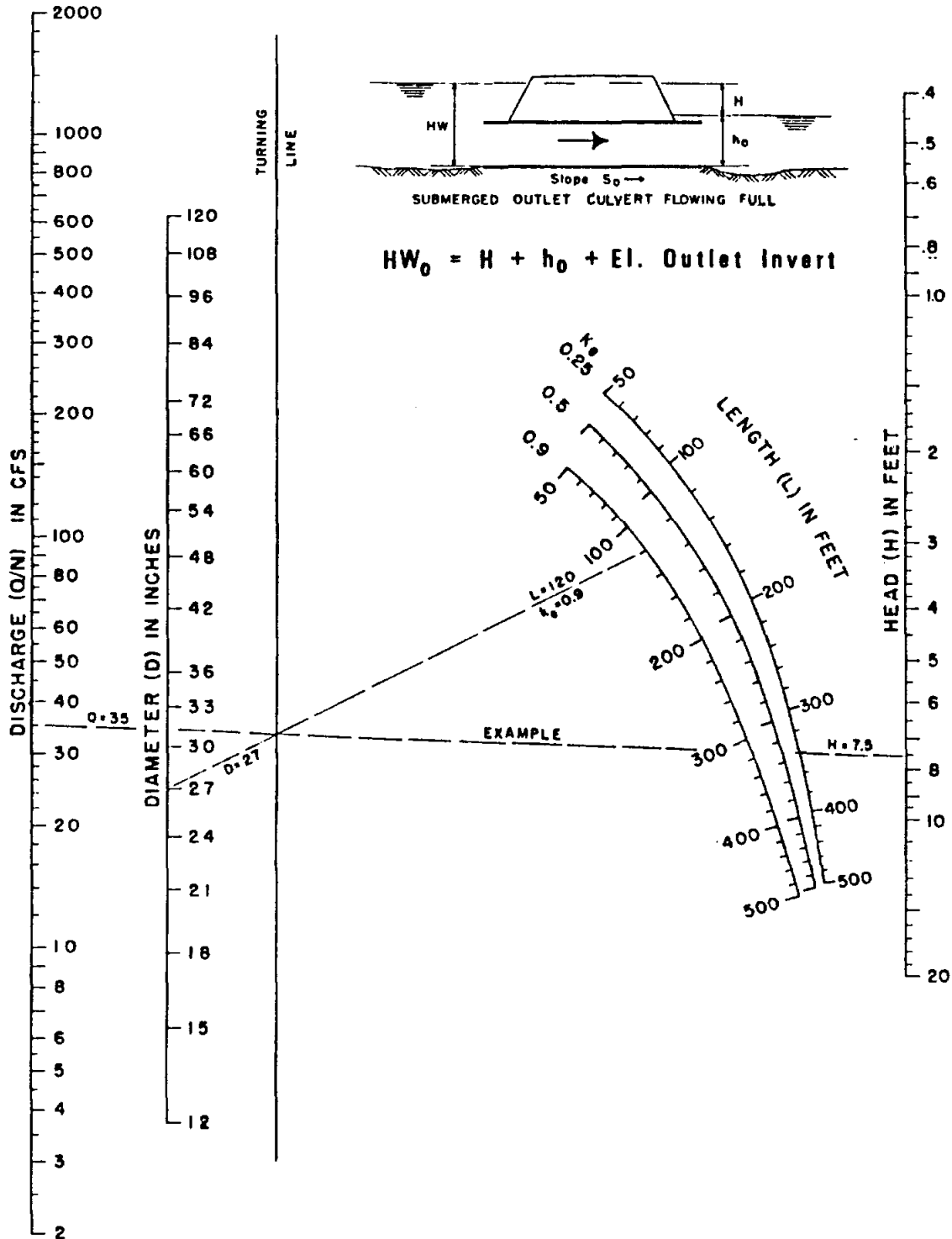

FIGURE 7-13

INLET CONTROL NOMOGRAPH - HEADWATER DEPTH FOR CONCRETE PIPE CULVERTS WITH INLET CONTROL

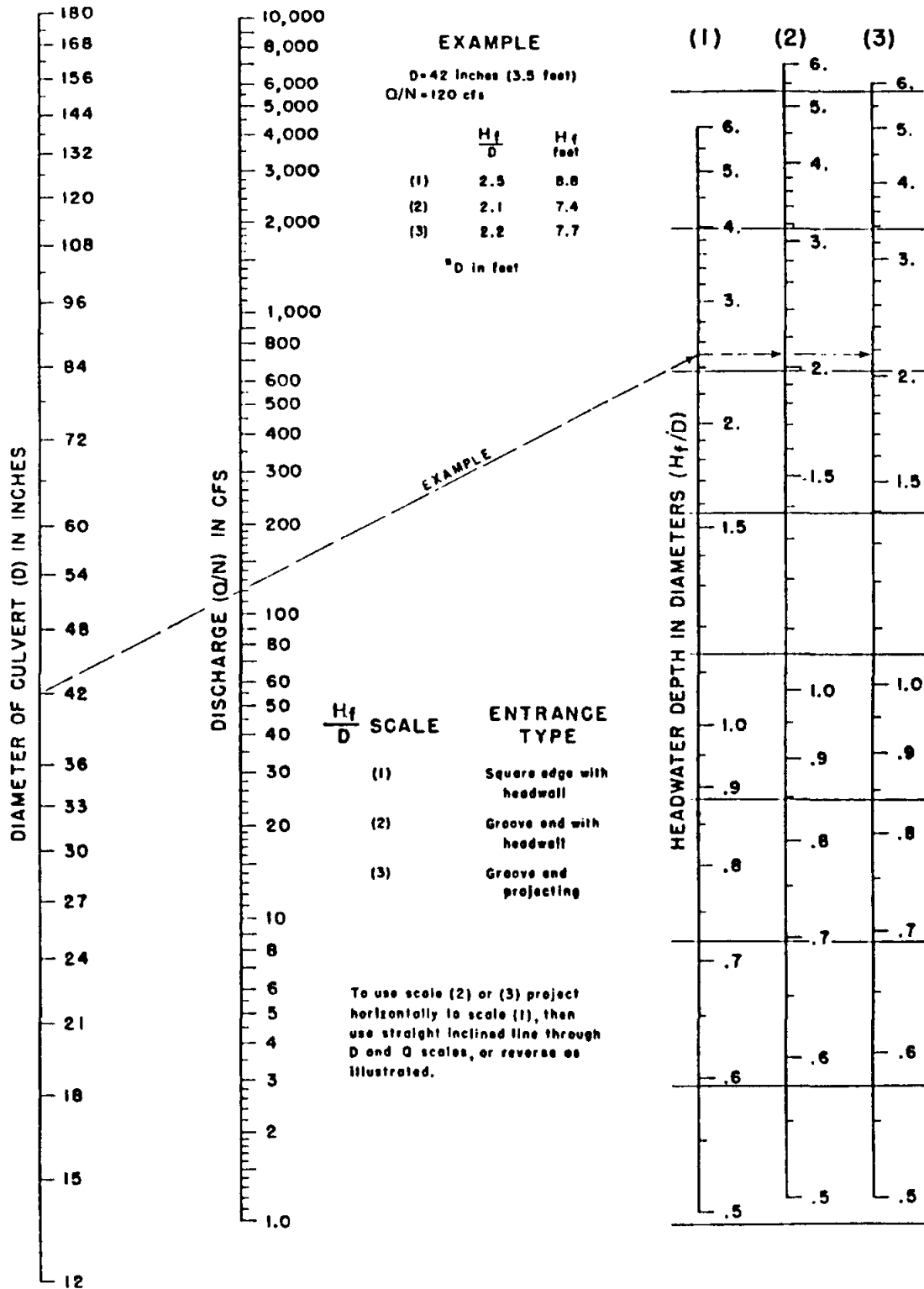
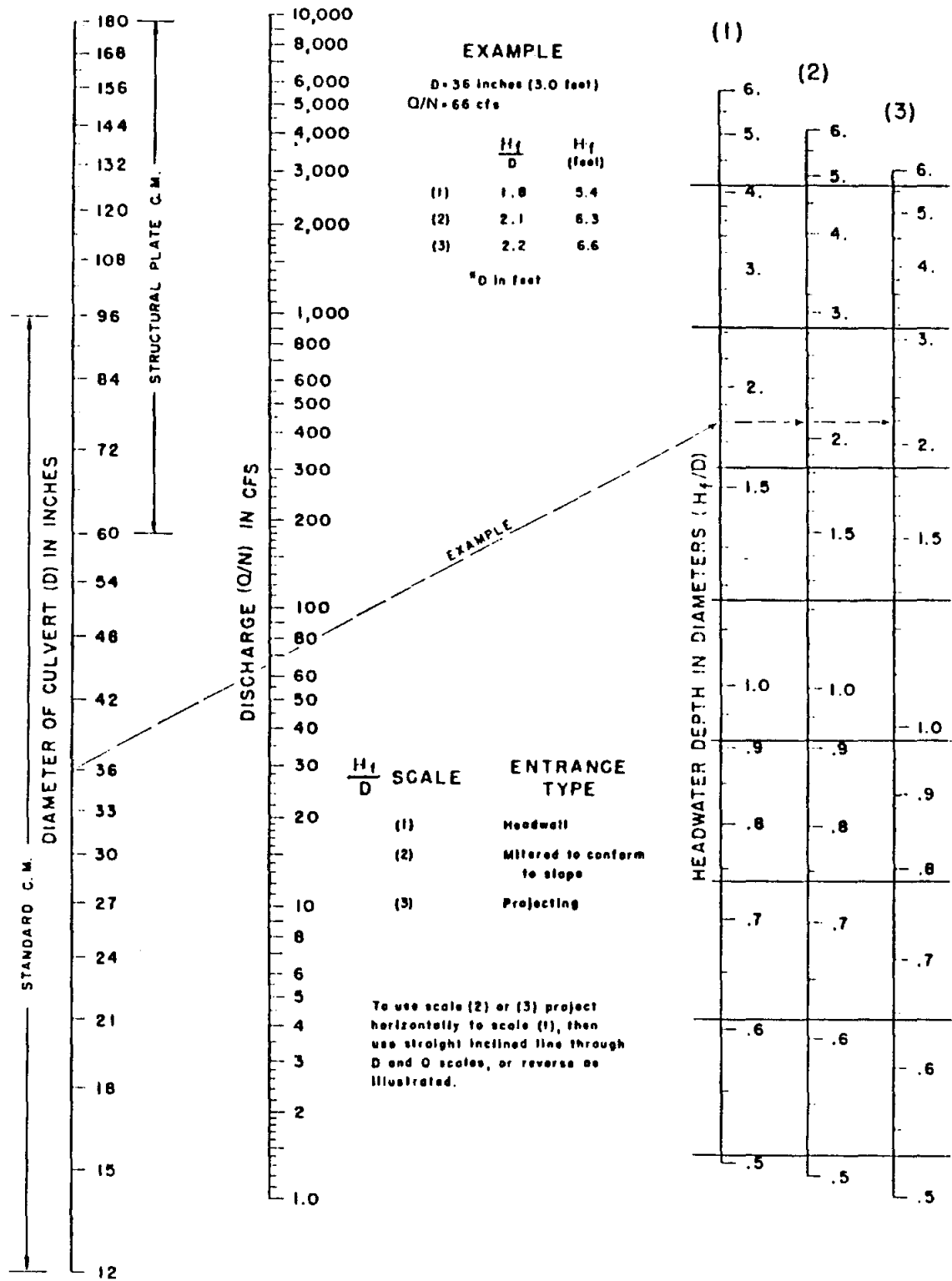

FIGURE 7-14

INLET CONTROL NOMOGRAPH - HEADWATER DEPTH
FOR C. M. PIPE CULVERTS WITH INLET CONTROL



PROJECT: _____

DESIGNER: _____

DATE: _____

HYDROLOGIC AND CHANNEL INFORMATION

Q₁ = _____ TAILWATER ELEVATION = _____

Q₂ = _____ TAILWATER ELEVATION = _____

(Q₁ = DESIGN DISCHARGE, SAY Q₂₅
Q₂ = CHECK DISCHARGE, SAY Q₅₀ OR Q₁₀₀)

SKETCH

STATION: _____

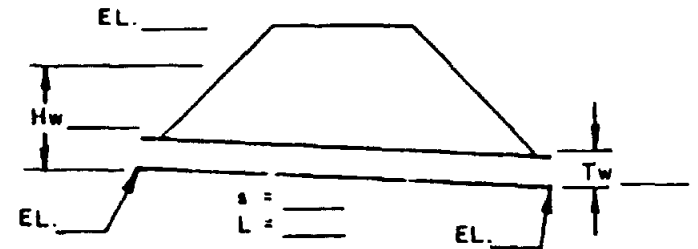

MEAN STREAM VELOCITY = _____
MAX. STREAM VELOCITY = _____

$\frac{L}{100s} =$ _____

7-23

DESIGN COMPUTATION FORM

FIGURE 7-15

CULVERT DESCRIPTION (ENTRANCE TYPE)	Q	SIZE	HEADWATER COMPUTATION										CONTROLLING HW	OUTLET VELOCITY	COST	COMMENTS			
			INLET CONT.		OUTLET CONTROL HW = H + h ₀ - Ls						CHART								
			$\frac{Hw}{D}$	Hw	K _e	H	d _c	$\frac{d_c + D}{2}$	Tw	h ₀	Ls	Hw					No.	Hw	

SUMMARY & RECOMENDATIONS:

SECTION 8 - BRIDGES

8.10 GENERAL

When it has been determined that a bridge will be placed at a stream crossing, the following procedures will be used to hydraulically design the bridge, unless the County Commissioners determine that a more detailed analysis shall be done. All bridges shall be designed to pass a 100-year frequency storm event with no more than one foot of head loss.

It should be noted that columns, piers, etc., will not be considered in the following discussions. Usually, they can be neglected. However, their effect in reducing the waterway opening should not be neglected if they constitute a substantial cross-sectional area themselves. This is particularly true in the case of skewed crossings with normal bents.

Throughout the discussions of bridge design, it is assumed that normal cross sections and lengths are used; that is, cross sections and lengths which are perpendicular to the direction of stream flow at flood stage. If the crossing is skewed to the stream flow at flood stage, all cross sections and lengths should be normalized before proceeding with bridge length design. If the skew is severe and the floodplain is wide, elevations in the normalized section may need to be adjusted to offset the effects of elevation changes in the point displacement between the skewed section and the normalized section.

Often structural and other considerations will cause a bridge opening to be larger than the bridge opening required by hydraulic design. For instance, a header might be placed in a certain location due to soil instability, or bridge costs might be cheaper than embankment costs, or a fixed grade line might dictate an excessive freeboard allowance. These and others are valid considerations that affect bridge waterway openings; however, hydraulic computations are necessary in order to predict the operation of the waterway opening at flood stages. Hydraulic design is not to be neglected, and reasons should be noted for any specified opening in excess of that determined by hydraulic design.

8.20 TERMINOLOGY

Design Highwater Elevation - A calculated water surface elevation in the natural channel for the design discharge. This is the elevation that is the basis for all bridge length calculations.

Backwater - Depth of water that ponds above the design highwater elevation in order to force the design discharge through a restricted opening. This term is used primarily for bridge span type structures (see Figure 8-3).

Conveyance (K) - Carrying capacity based on the Manning equation of a specific cross section or portion thereof as defined by:

$$K = \frac{1.486 AR^{2/3}}{n}$$

Natural stream conveyance - The sum of all subsection conveyances throughout a cross section of the natural stream for a specific highwater elevation. Structure conveyance is the sum of the conveyances for each individual opening for a specific highwater elevation. The two conveyances (natural K and structure K) must be designated to keep them separate, because they are not to be related to each other.

Freeboard - That clearance between water surface elevation and low superstructure. A minimum freeboard of 2 feet above observed highwater or design highwater, whichever is greater, shall be used.

8.30 FLOW THROUGH BRIDGES

Compared to culvert flows, flow through bridge openings requires that more emphasis be put on viewing the entire pattern of flow in the floodplain, especially the flow approaching the bridge (or bridges). This is necessary because the relationship of floodplain width to opening width is more complex than for the usual culvert opening (see Figure 8-1).

FIGURE 8-1

PATTERN OF FLOW THROUGH BRIDGE OPENINGS

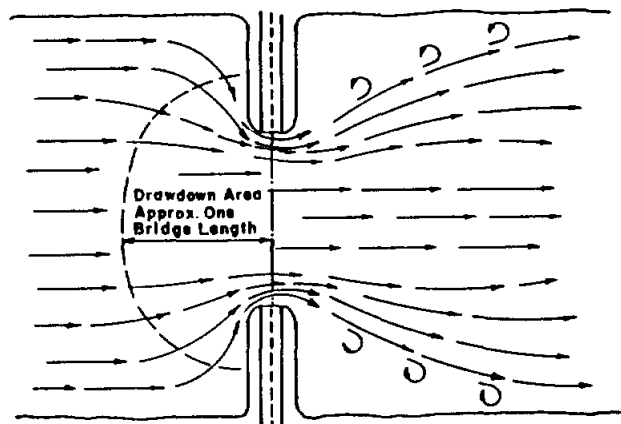

When flood flow encounters a restriction in the natural stream, certain natural adjustments take place in the vicinity of the restriction. That portion of the flow not directly approaching the bridge opening has no convenient way to continue downstream. The flow, therefore, will pond until sufficient head is built up to force it to turn toward the bridge, and generally move parallel to the highway embankment. As the flow moves toward the bridge opening, the velocity increases above the natural floodplain velocity. This increased velocity can cause scour, sometimes severe, along the highway embankment and particularly at the bridge header. At the header, the intersecting velocity vectors cause high turbulence and eddies that often result in the failure of an interior bent near this turbulence (see Figure 8-2). If there is only a single structure, the flow will find its way to the single structure. If two or more structures are available, the flow, after accumulating a head, will divide and flow to the structure offering the least resistance. This point of division is called a flow divide.

In usual practice, it is recommended that the flood discharge be forced to flow parallel to the highway embankment for no more than 600 to 800 feet. If flow distances along the embankment are greater than recommended, then a relief structure to provide additional opening should be investigated, or a spur dike is recommended to control the turbulence at the header. Also, natural vegetation remaining between the toe of the slope and the right-of-way line is advantageous in controlling flow along the embankment.

Multiple structures and spur dikes are discussed in Sections 8.50 and 8.60.

The backwater effect caused by the constriction in the natural stream is depicted in Figure 8-3, and pertinent design considerations are given in Section 8.40.

The waterway opening defined by design highwater, the left and right header slopes, and the natural ground profile (or proposed through-bridge channel section) should be such as to cause an average through-bridge velocity of from 4 to 6 feet per second. This can be accomplished by simply moving the header slopes nearer together or farther apart as necessary. Average through-bridge velocities higher than 6 feet per second must be approved by the County Commissioners.

The average through-bridge velocity used throughout this chapter is calculated by the formula:

$$V = Q/A$$

where:

V = Average velocity in ft/sec.

A = Normal cross-sectional area of the water in ft².

Q = Design discharge in ft³/sec.

FIGURE 8-2
TURBULENCE AT HEADERS

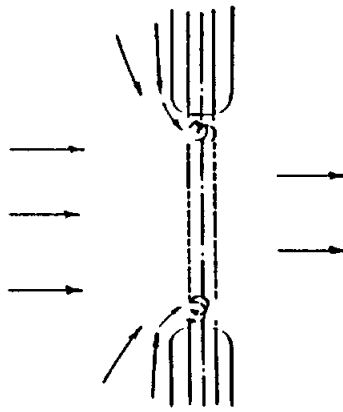
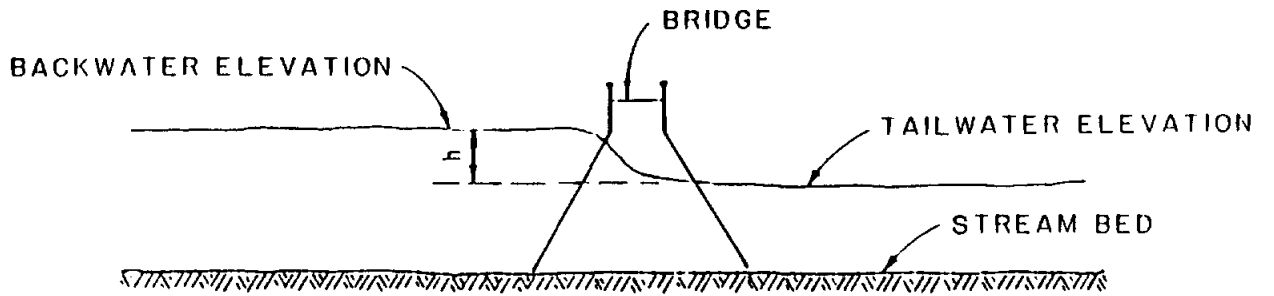

FIGURE 8-3
BACKWATER



8.40 SINGLE STRUCTURE

"Single structure" refers to the crossing of a floodplain which requires only one opening in the highway embankment.

The following is the recommended procedure (Ref. 7) for establishing a single structure length and elevation of low superstructure after obtaining an accurate cross section and determining the design highwater elevation.

Step 1. Assume average trial through-bridge velocity (V_t) that is less than the maximum allowable velocity and more than 4 fps.

Step 2. Find water cross-sectional area (A_t) required for trial velocity.

$$A_t = Q/V_t$$

Step 3. Estimate average depth of water (D_t) in cross sections.

Step 4. Find approximate trial length (L_t) of waterway opening.

$$L_t = A_t/D_t$$

Step 5. Position headers in stream cross section so that they average approximately L_t feet apart.

Step 6. Find exact waterway area (A) below design highwater within structure limits.

Step 7. Find average through-bridge velocity (V_{struct}) for the actual waterway area.

$$V_{struct} = Q/A$$

Step 8. If V_{struct} is greater than 4 fps and less than 6 fps, the bridge length sizing is complete. This length can usually be adjusted slightly to fit span length requirements.

If V_{struct} is not greater than 4 fps and less than 6 fps, the length should be adjusted as necessary and the process returns to Step 5. This routine should be repeated as often as necessary until average through-bridge velocity is within the prescribed velocity range.

Step 9. The low steel or low concrete of the structure should be placed at an elevation that provides at least 2 feet of freeboard over the design highwater. Often, some observed highwater exceeds the design highwater. In this case, it is usual practice to clear the higher of the highwaters. In any event, the design highwater should be used in the bridge length determination.

Step 10. The backwater caused by the constriction of the bridge opening should be approximated by the following formula.

$$h = \frac{V_{\text{struct}}^2 - V^2}{2g}$$

where:

h = Increase in depth over design highwater in ft.

V_{struct} = Average through-bridge velocity.

V = Average unrestricted natural stream velocity in ft/sec.

g = Acceleration of gravity, 32 ft/sec².

8.50 MULTIPLE STRUCTURES

Due to a relatively wide floodplain or multiple discharge concentrations (as opposed to a single concentration), it may be necessary to design multiple openings. This is usually referred to as a main channel bridge with relief openings. This type of crossing simply provides openings at or near the flow concentrations so as to reduce along-embankment flow and reduce backwater effects.

Multiple structures should be designed so that their relative carrying capacities (or structure conveyances) match the predicted relative discharges approaching them. This is necessary because each bridge must have the capacity to carry its share of the discharge. Otherwise, those bridges whose capacity is less than necessary will be overloaded with resultant high velocities and, in effect, will cause a reapportionment of the approach discharges. This, in turn, will cause high backwaters and high along-embankment velocities. In addition to making this balance in proportion, the designer must satisfy average through-bridge velocity requirements.

8.51 Flow Distribution

After determination of the design highwater at a multiple structure location, it is still necessary to determine just how the flow divides itself across the floodplain at flood stage. If the flow divides, as in the case of multiple structures, determine the portion of the total flood discharge that will be carried by each structure as previously stated in Section 8.30.

One of the best methods for accomplishing this is by actual observation of the flow at design discharge and highwater at the proposed site. However, it is rare that the engineer is able to make such an observation when the proper set of circumstances occurs. Therefore, the following method has been devised for determining flow distribution and establishing flow divides (Ref. 7).

Inspection of incremental discharges or conveyances across a floodplain cross section usually reveals where the relatively heavier concentrations of flow are located. By determining these heavier concentrations of flow, the engineer usually can decide the proper locations for each of the bridges. The most straightforward method of spotting these heavy concentrations of flow is by use of a cumulative conveyance (or discharge) curve. This curve is constructed as follows:

- Step 1. Apply the design highwater to a natural stream cross section in the immediate vicinity of the proposed design section. The section chosen for this highwater application should be a typical section which will definitely control the flow distribution in the reach of the stream wherein the structure is located.
- Step 2. Calculate cumulative natural conveyances for each subarea across the section from left bank to right bank (Figure 8-4). (Discharges may be calculated, but all this requires is multiplication of conveyances by the square root of the stream slope. This is an extra step and nothing is actually gained by it since the final shape of the curves would be the same.)
- Step 3. These cumulative natural conveyance values are plotted versus the cross-sectional stationing creating a curve as shown in Figure 8-4; the value of the last plot is equal to the total conveyance of the stream section.
- Step 4. By inspection of this curve, it is seen that, in the vicinity of points 1, 2, and 3, the slope of the curve is relatively steep. This is caused by a rapid increase in natural conveyance with respect to distance across the section. These points define the approximate best locations for bridges. The points on the curve where the curve has the flattest slopes define the approximate locations of flow divides.

That portion of the design discharge carried between the flow divides should be determined by direct calculation or by proportion of relative natural conveyances (Figure 8-4). At this point, the relative discharges have been determined.

FIGURE 8-4
CUMULATIVE CONVEYANCE CURVE

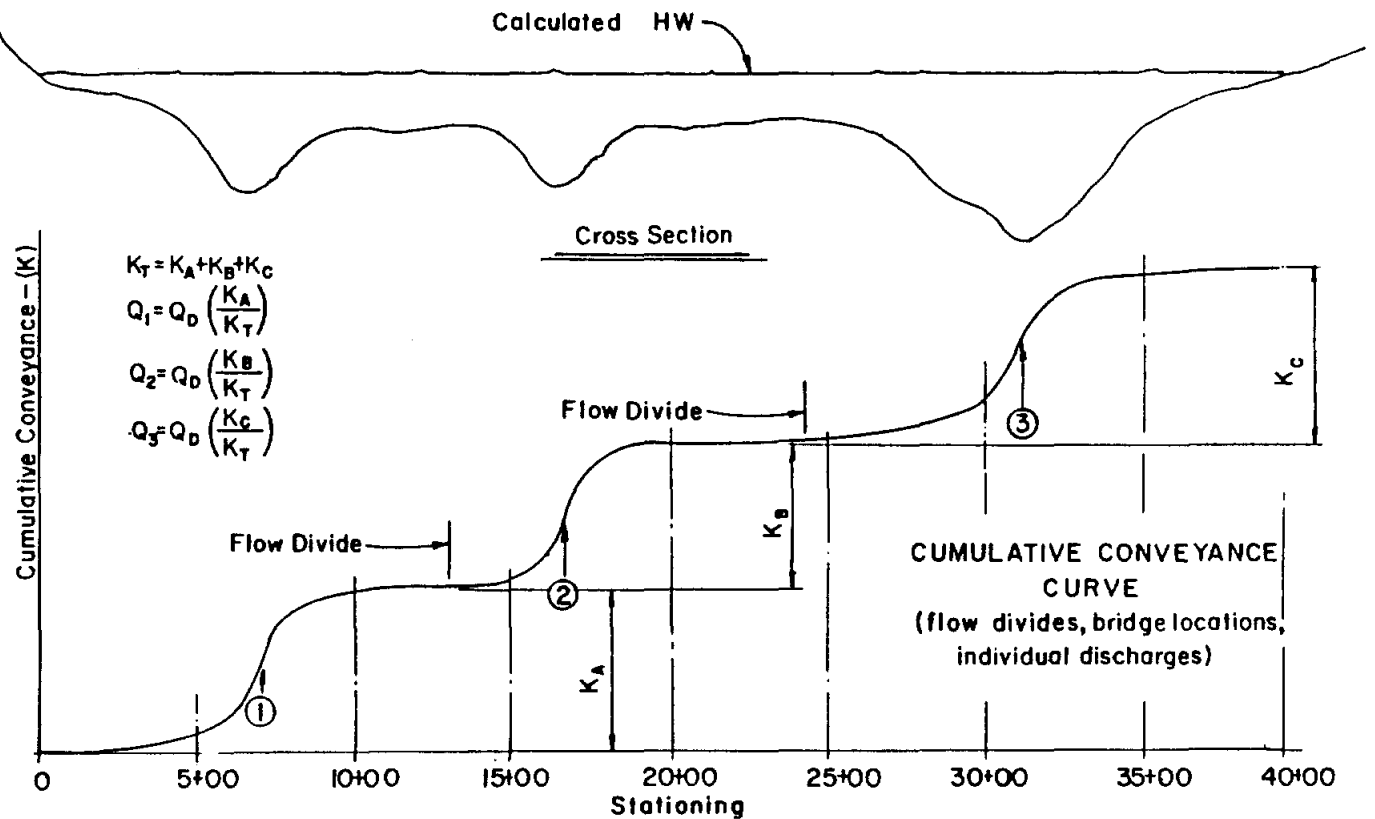

8.52 Design Of Multiple Structures

The design procedure (Ref. 7) to be followed in establishing the size of multiple waterways is outlined below. Q_D is the design discharge and subscripts 1, 2, and 3 refer to left floodplain, main channel, and right floodplain, respectively. This example makes use of 3 bridges. However, there may be more than 3 bridges or only 2 bridges. The procedure is the same in any case.

- Step 1. Using 4 fps as minimum allowable velocity and 6 fps as a maximum allowable velocity, determine the approximate average velocity (V_D) of all 3 openings.

$$V_D = \frac{V_{\max} + V_{\min}}{2}$$

- Step 2. Determine approximate total waterway opening, A_D .

$$A_D = Q_D / V_D$$

Step 3. Determine approximate waterway opening (A_i) for bridge 1, bridge 2, and bridge 3.

$$A_1 = \frac{Q_1}{Q_D} \times A_D$$

$$A_2 = \frac{Q_2}{Q_D} \times A_D$$

$$A_3 = \frac{Q_3}{Q_D} \times A_D$$

Step 4. With A_1 , A_2 , and A_3 , and assuming average water depths (D_1 , D_2 , and D_3), determine approximate structure lengths (L_1 , L_2 , and L_3).

$$L_1 = \frac{A_1}{D_1}, \text{ etc.}$$

Step 5. Determine structure conveyances K_1 , K_2 , and K_3 .

$$K_j = \frac{1.486}{n} AR^{2/3}$$

Neglecting the constant 1.486, a relative conveyance factor to be used in apportioning the total flow between openings is

$$K_j = \frac{AR^{2/3}}{n}$$

In the case where under-bridge terrain is expected to be similar for each bridge, "n" is constant and relative conveyances may be evaluated as

$$K_j = AR^{2/3}$$

then $K_T = K_1 + K_2 + K_3$. If the values K_1/K_T , K_2/K_T , and K_3/K_T are approximately equal to Q_1/Q_D , Q_2/Q_D , and Q_3/Q_D , respectively, the structure conveyances are said to be balanced. Otherwise, adjustments in individual bridge lengths should be made in order to effect this balance of proportions.

Step 6. Determine velocity requirements that must be met in addition to the proportion balancing of conveyances. With the trial waterway openings, the velocity requirements should be checked. Approximate velocity

through each structure ($V_{\text{struct}} = Q/A$) should be not less than 4 fps or greater than 6 fps. Note that a change in one or more bridge lengths affects the total conveyance. Therefore, any change made should be accompanied by recalculation of relative structure conveyances.

Step 7. Determine backwater head approximated by the formula:

$$h = \frac{V_1^2 - V_2^2}{2g}$$

where:

V_1 = Average through-bridge velocity for all openings in ft.

V_2 = Approach velocity in natural stream in ft/sec.

g = Acceleration of gravity, 32 ft/sec².

8.60 SPUR DIKES

Spur dikes are beneficial at sites where the distance of the flow travel along the embankment is in excess of 600 feet. Spur dikes are also advantageous for improving the characteristics of flow through a single structure.

Spur dikes have the advantage of initial economy and the fact that they are convenient and inexpensive to maintain. They function by directing along-embankment flow out away from the bridge opening. This causes any parallel-embankment velocity to be removed from the embankment itself and serves to greatly reduce the under-bridge turbulence usually caused by intersecting flow vectors. If scour is still a problem, the end of the spur dike is eroded and not the bridge header. Figure 8-5 shows the recommended geometry of spur dikes and affected stream flow. The top of spur dike elevation should be above design highwater elevation a minimum of 2 feet. Also, it is recommended that natural vegetation be left around the end of the spur dike.

FIGURE 8-5

SPUR DIKE

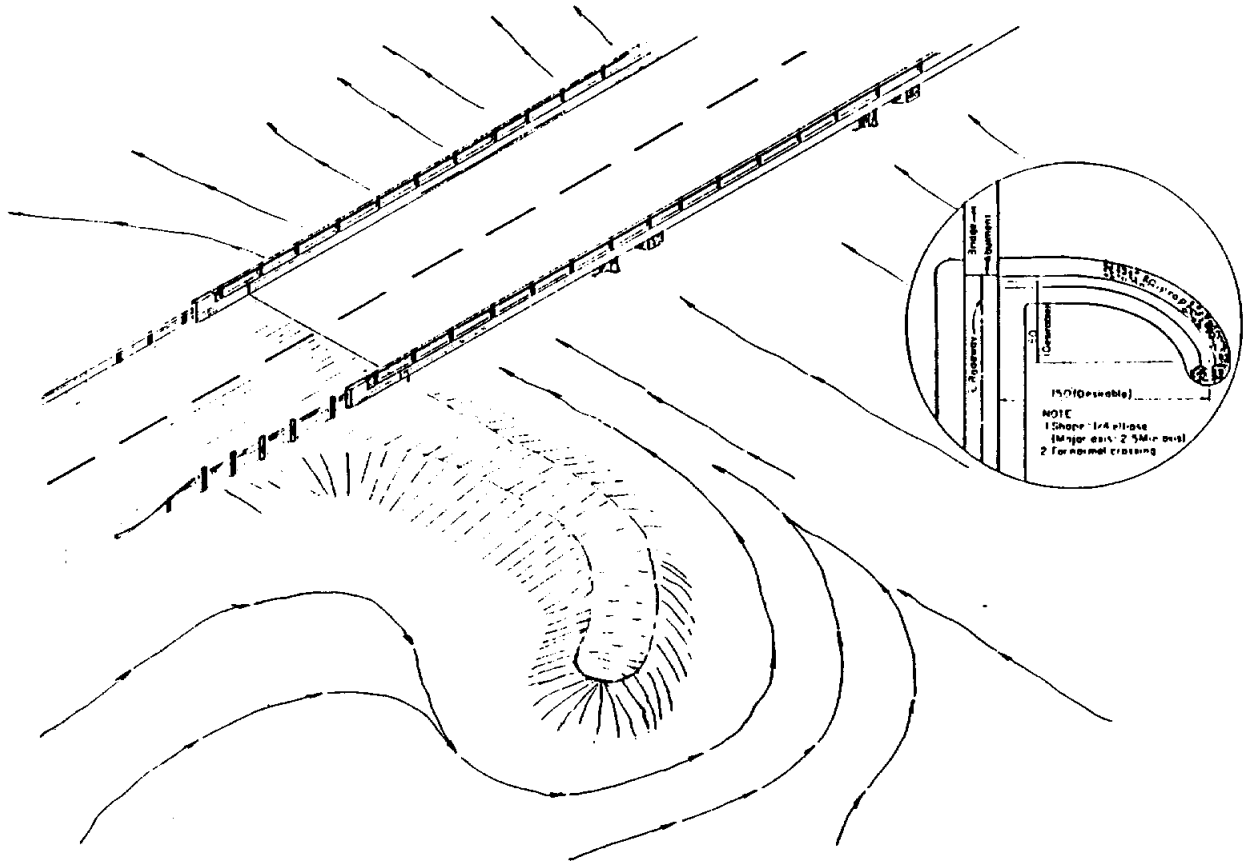

REFERENCES

1. City of Austin, Engineering Department et al., Drainage Criteria Manual, Austin, Texas, 1977.
2. Federal Highway Administration, Hydraulic Charts for the Selection of Highway Culverts, USGPO, Washington, D.C., 1965.
3. Federal Highway Administration, Capacity Charts for the Hydraulic Design of Highway Culverts, USGPO, Washington, D.C., 1965.
4. Federal Highway Administration, Hydraulic Design of Improved Inlets for Culverts, USGPO, Washington, D.C., 1972.
5. U.S. Weather Bureau, Rainfall Intensity-Duration-Frequency Curves, Technical Paper No. 25, Supt. of Doc., Washington, D.C., Dec. 1955.
6. U.S. Weather Bureau, Rainfall Frequency Atlas of the United States, Technical Paper No. 40, Supt. of Doc., Washington, D.C., May 1961.
7. Texas Department of Highways and Public Transportation, Bridge Division, Hydraulic Manual, Third Ed., December, 1985.
8. City of Waco, Engineering Department, Storm Drainage Design Manual, Waco, Texas, 1959.
9. Chow, V. T., Handbook of Applied Hydrology, McGraw-Hill, New York, 1964.
10. Chow, V. T., Open Channel Hydraulics, McGraw-Hill, New York, 1959.
11. King, H.W., Handbook of Hydraulics, Fourth Ed., McGraw-Hill, New York, 1959.
12. U.S. Geological Survey, Techniques for Estimating the Magnitude and Frequency of Floods In Texas, Water Resources Investigations 77-110, Open-File Report, 1977.
13. Portland Cement Association, Design and Construction of Concrete Sewers, Portland Cement Association, Skokie, Illinois, 1968.
14. Portland Cement Association, Handbook of Concrete Culvert Pipe Hydraulics, Portland Cement Association, Chicago, 1964.
15. Bauer, W.J. and Woo, Hydraulic Design of Depressed Curb-Opening Inlets, Highway Research Board Record No. 58, Washington, D.C., 1964.
16. Federal Highway Administration, Drainage of Highway Pavements, Hydraulic Engineering Circular No. 12, 1969.
17. Izzard, Carl F., Simplified Method for Design of Curb-Opening Inlets, Annual Meeting of the National Transportation Board, January, 1977.

18. Karaki, S.S. and Haynie, R.M., Depressed Curb-Opening Inlets -- Experimental Data, Colorado State University, Civil Engineering Section, Fort Collins, Colorado, 1961, CER61SSK34.
19. National Research Council, Building Research Advisory Board, A Study of Invert Crown Residential Streets and Alleys, Federal Housing Administration, Washington, D.C., 1957.
20. Oglesby, H., and Hewes, I., Highway Engineering, John Wiley and Sons, New York, 1954.
21. Searcy, J.K., Design of Roadside Drainage Channels, U.S. Bureau of Public Roads, Hydraulic Design Series No. 4, USGPO, Washington, D.C., 1965.
22. Linsey, K.; Kohler, M.A.; and Paulhus, J.L.H., Hydrology for Engineers, Second Ed., McGraw-Hill, New York, 1965.
23. Schulz, E.F., Problems in Applied Hydrology, Water Resources Publications, Fort Collins, Colorado, 1974.
24. Soil Conservation Service, SCS National Engineering Handbook, Section 4, Hydrology, U.S. Department of Agriculture, August, 1972.
25. Soil Conservation Service, Urban Hydrology for Small Watersheds, Technical Release No. 55, U.S. Department of Agriculture, 1975.
26. City of Omaha, Omaha Metropolitan Area Stormwater Management Design Manual, Omaha, Nebraska, 1980.
27. Agricultural Research Service, Using the Cypress Creek Formula to Estimate Runoff Rates in the Southern Coastal Plain and Adjacent Flatwoods Land Resources Areas, ARS 41-95, U.S. Dept. of Agriculture, 1965.